

FORD TRANSIT MID-ROOF PARTITION



PRODUCT WEIGHT

73 LBS

WIDTH x DEPTH x HEIGHT

68.3" x 8.25" x 69.5"

CAPACITY

N/A

COLOR

BLACK

CATALOG NUMBER

PARFTM-NW

PRODUCT FEATURES

Composite partition for FORD TRANSIT MID ROOF provides a semi-sealed solution for separating the cab area from the cargo area. The composite partition features a full perimeter bulb seal that seals off the majority of the airflow from the cab area to the cargo area. This feature provides better climate control for the cab area and reduces noise transfer from the cargo area to the cab area.

**** This WILL work with dual side sliding door option ****

Driver Comfort Details

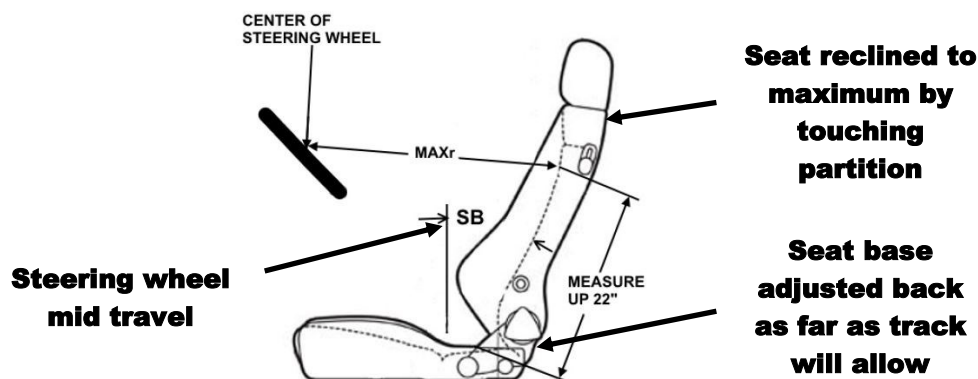

	DESCRIPTION	DIMENSION
SB	SEAT BACK ANGLE	12 degrees
MAXr	MAXIMUM DRIVER REACH	31"

SEE PAGE 2 FOR APPLICATION NOTES AND ACCESSORIES, OTHER PRODUCTS THAT WORK WITH THIS UNIT.

PAGE 1 of 2

The information contained in this document is the sole property of ADRIAN STEEL COMPANY. ADRIAN STEEL COMPANY retains the right to modify and/or change the product of its design at any time without prior notification.

Accessory Chart

	Cargo Side			Cab Side		
	Base Partition BAGRKA1 REQUIRED (1 BAGRKA1 will allow for one accessory to be added)	PARHDW Fastener Kit Allow accessories to be added directly mounted to partition	PARFTMCRG (mounting kit cargo side)	Base Partition 1/4" nuts and bolts REQUIRED	PARHDW Fastener Kit Allow accessories to be added directly mounted to partition	PARFTMCAB (mounting kit cab side)
Available Accessories	-	-	-	-	-	-
PA7: Reflector kit	X	X	X	X	X	X
PA8: Fire ext.	X	X	X	X	X	X
PA9: First aid tray	X	X	X	X	X	X
PA10: Practice holder			X			X
PA11: Cab file			X	X		X
PA11NL: Catalog box			X	X		X
TA1: Four hook bar			X			X
CCD6: Center console 6"						X
TDC6: Tech desk 6"						X
TH30: 30lb tank holder			X			
TH50: 50lb tank holder			X			
UH50RM1: Rail mount kit			X			X
UH10: 1" hook			X			
UH25: 2.5" hook			X			
UH25CP-G: 2.5' hook comp			X			
UH50: 5" hook	X		X			

PARFTMCRG (shown in yellow)
Cargo side hardware mounting kit installed

PARFTMCAB (shown below in yellow)
Cab side hardware mounting kit installed

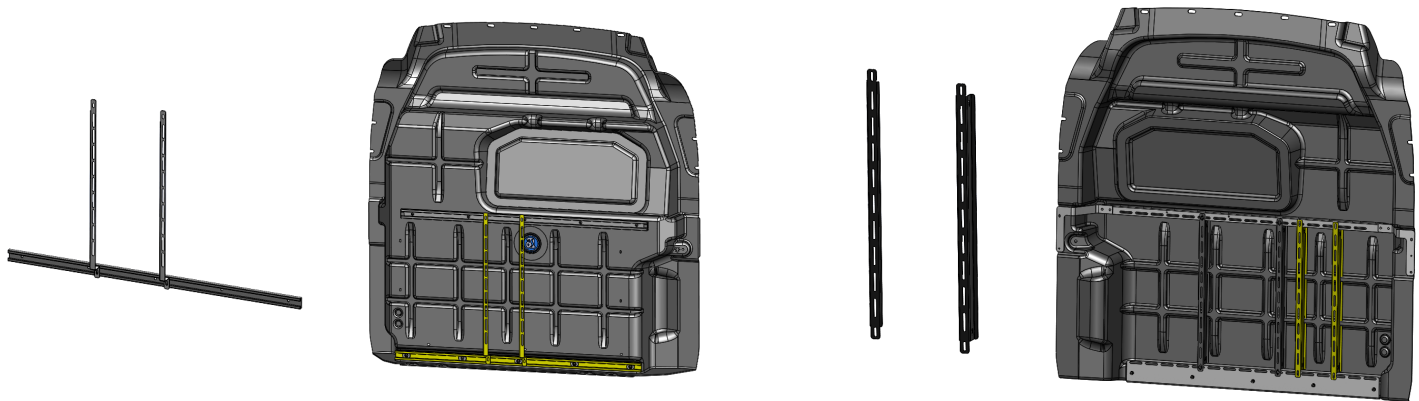

PARHDW Fastener Kit

Fastener kits allow for installation of smaller and lighter (up to 12 lbs.) Allows accessories to be directly mounted to the partition, such as: fire extinguisher, flare kit, first aid kits, acc.



Assembly/Installation Instructions and Owners Manual

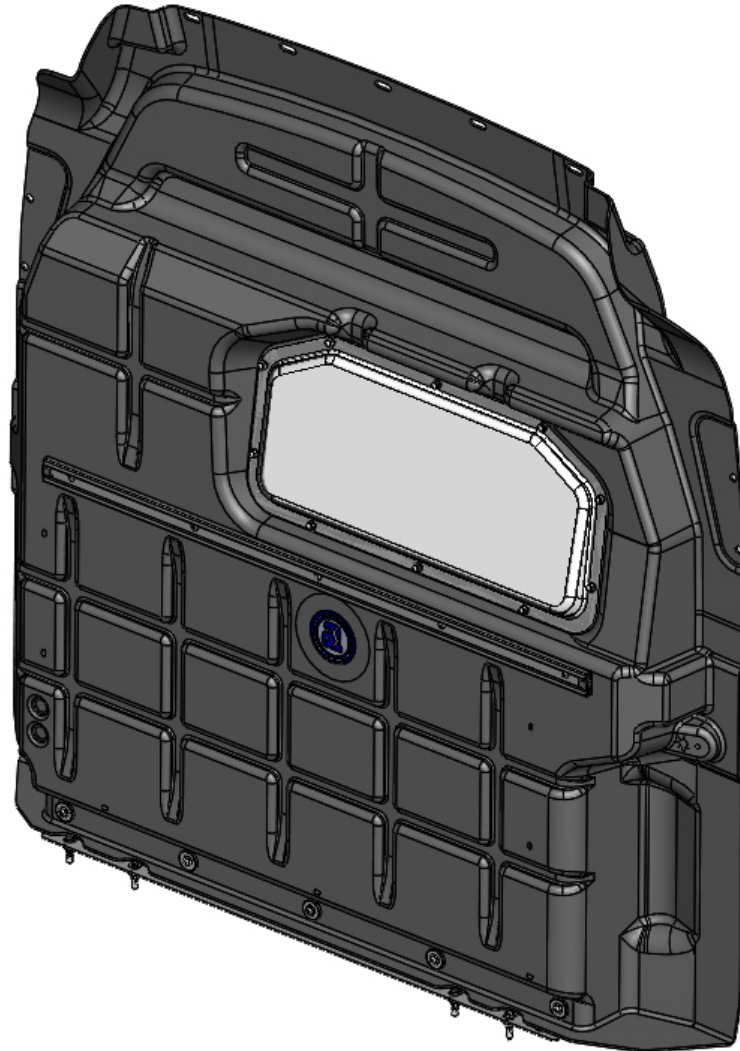

(PARFTM SHOWN)

COMPOSITE PARTITIONS **PARFTM & PARFTM-NW** **PARFTH & PARFTH-NW** FOR FORD TRANSIT FSV, MID AND HIGH ROOF VANS

- PRECAUTIONS -





 **CAUTION** 
**THE USE AIR IMPACT TOOLS CAN
OVER-TORQUE FASTENERS AND
CAUSE FASTENER FAILURE!**



 **CAUTION** 
**ALL INSTALLATION HOLES SHOULD BE SEALED
WITH SILICON OR BUTYL SEALANT TO PREVENT
EXHAUST FUMES FROM ENTERING THE VEHICLE!**



 **DANGER** 
**INSPECT FOR FUEL TANK, FUEL LINES, BRAKE LINES, HIGH
VOLTAGE BATTERIES AND ELECTRICAL LINES PRIOR TO
DRILLING TO AVOID DAMAGING CRITICAL VEHICLE SYSTEMS
OR INJURY TO INSTALLER DURING INSTALLATION PROCESS!**



 **CAUTION** 
**TO AVOID DAMAGING THE VEHICLE ALWAYS
USE DRILL STOPS WHEN DRILLING ANY IN-
STALLATION HOLES!**



- IMPORTANT WARRANTY REQUIREMENTS -

1. SUBSTITUTING ADRIAN STEEL SPECIFIED FASTENERS FOR ASSEMBLY AND/OR INSTALLATION WILL VOID YOUR PRODUCT WARRANTY.
2. ALL HOLES DRILLED INTO VEHICLE SHOULD HAVE THE RAW METAL EDGES SEALED WITH A SELF-ETCHING PRIMER TO RESIST CORROSION AND POTENTIAL FASTENER POINT FAILURE.
3. ALL FASTENERS USED IN THE INSTALLATION OF THIS PRODUCT SHOULD BE TIGHTENED TO THE TORQUE(S) SPECIFIED IN THESE INSTRUCTIONS.
4. THESE INSTRUCTIONS SHOULD BE KEPT WITH THE VEHICLE.

THE BASIC TOOLS NEEDED FOR MOST INSTALLATIONS



DRILL



DRILL BIT WITH
STOP



RATCHET, SOCKETS
AND/OR WRENCHES



SCREWDRIVERS





MEASURING TAPE

ADDITIONAL TOOLS MAY BE NEEDED FOR THIS INSTALLATION AND THEY WILL BE IDENTIFIED IN THE STEPS THAT FOLLOW.

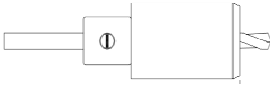

WHEN INSTALLING PLUSNUTS MAKE SURE YOU USE THE CORRECT DRILL BIT WITH A STOP!

PLUSNUT SIZE	DRILL BIT SIZE
1/4-20 PLUSNUT, FAS0052	USE A 3/8" DIAMETER DRILL BIT WITH A STOP.
5/16-18 PLUSNUT, FAS0091	USE A 1/2" DIAMETER DRILL BIT WITH A STOP.
 OR  NOTE: A PLUSNUT SETTING TOOL IS REQUIRED FOR PLUSNUT INSTALLATION AND IS NOT SUPPLIED WITH THIS KIT. ORDER PLUSNUT TOOLS FROM ADRIAN STEEL (P.N. 22200-0)OR USE AN AIR POWERED PLUSNUT SETTING GUN.	
NOTE: If your vehicle contains carpet or a rubber floor mat you will need to prepare the mounting locations using a 1-3/16" carpet cutter.	1-3/16" DIAMETER CARPET CUTTER P.N. 31183-0. 

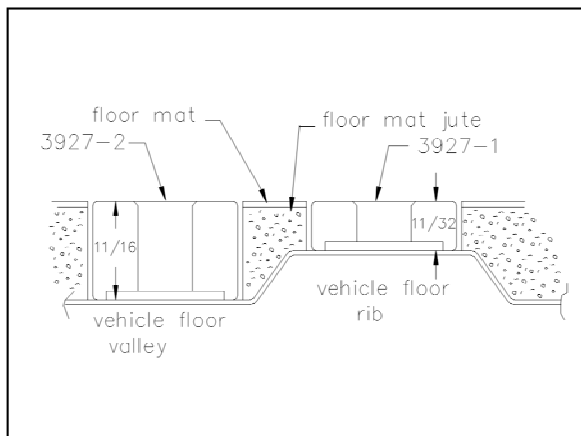

Step 01
Optional Based on Vehicle

If your vehicle contains carpet or a rubber floor mat you will need to prepare the mounting locations. (if not, skip to STEP 02)

Position the product to be installed into the vehicle and once you are satisfied with the mounting locations, mark the mounting locations. Using a 1-3/16" diameter carpet cutter. Select the appropriate floor spacers as shown in the illustration to the left. Set those aside for use later into the installation process.

Once you have prepared the carpet/floor mat for mounting, proceed to **STEP 02**.

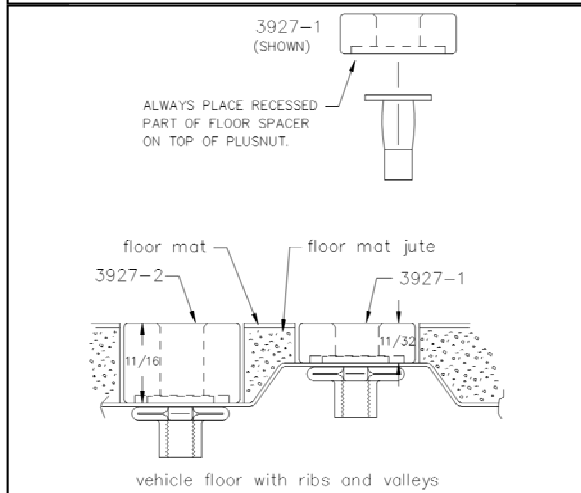

Step 02
Prepare Mounting Locations

Using a drill and drill bit (see table at top of page for correct size) drill the mounting holes in the vehicle sheet metal to prepare for installing the plusnuts.

If you are thru-bolting at any of the locations simply drill a hole that is 1/16" larger than the bolt size(s) for those locations.

Once you have drilled the holes into the vehicle, the raw metal edges should be sealed using a self-etching primer to resist corrosion and potential fastener point failure.

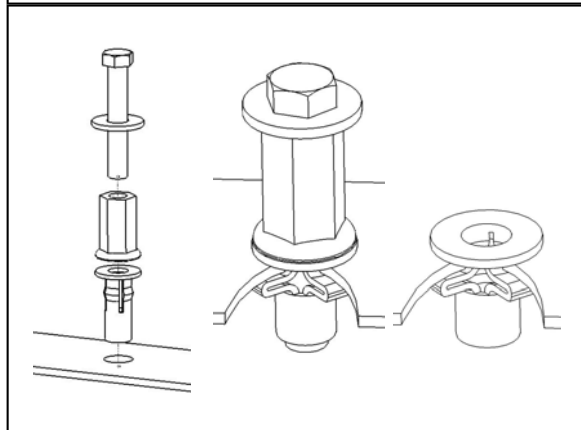

Step 03
Setting Plusnuts

Use an Air Powered Plusnut Setting Gun to "set the plusnut" or if installing manually with hand tools, assembly the following.

- 1/4-20UNC Plusnut (FAS0052)
- FAS0080 SCREW, HXHD, 1/4-20UNCx2.00, G8
- FAS0067 WASHER, FLAT, 1/4"ID
- 22200-0 PLUSNUT TOOL
- 5/16-18UNC Plusnut (FAS0091)
- FAS0095 SCREW, HXHD, 5/16-18UNCx2.00", G8
- FAS0086 WASHER, FLAT, 5/16"ID
- 22200-0 PLUSNUT TOOL

Place barrel of the plusnut body in sheet metal thru hole until flange is flush with sheet metal.

Using a 9/16" combination wrench of plusnut tool body and a second hand wrench, ratchet, or air tool, rotate the hex bolt head CW to draw plus nut flanges up (set the plusnut).

Remove hex bolt, washer, and plusnut. Inspect installation.

PARTS YOU WILL USE FOR STEP 01	DRILL/DRIVER	10MM SOCKET		
				

Instructions for Step 01



CAREFULLY REMOVE PASSENGER SIDE (AND DRIVERS SIDE IF INSTALLED) CARGO DOOR GRAB HANDLE. SET GRAB HANDLE AND FASTENERS ON PASSENGER SEAT FOR LATER USE.

REMOVE BOTH OF THE OEM D-RINGS FROM THE B-PILLARS AND DISCARD.

**NOTE:
OEM FASTENERS FOR THE GRAB HANDLES WILL BE REUSED LATER.**



PARTS YOU WILL USE FOR STEP 02	1/2" DIA. DRILL BIT WITH STOP 	DRILL 	1-3/16" HOLESAW 	PLUSNUT GUN OR SETTING TOOL 
	PAINT MARKER or CENTER PUNCH 	49908-B FOOTER RAIL 	PRIMER 	FAS0091 5/16-18 PLUSNUT (4) EA 

Instructions for Step 02



11TH 10TH

3RD 2ND



6-25/32"

LOCATE FOOTER RAIL AS SHOWN (OR USE PREVIOUSLY CREATED AND VALIDATED DRILL JIG) MARK FOUR (4) HOLE LOCATIONS. THE CENTER OF THE FOUR HOLE LOCATIONS ARE TO BE 6-25/32" BACK FROM THE B-PILLAR (SHEET METAL) SURFACE AND CENTERED ACROSS THE 2ND (FROM CURBSIDE), 3RD, 10TH AND 11TH FLOOR RIBS AS SHOWN.

NOTE: IF THE VEHICLE IS SUPPLIED WITH FOOTWELL TRIM THE FIRST FLOOR RIB WILL BE UNDER THE FOOTWELL TRIM. MARK THE FOUR (4) LOCATIONS. USE THE HOLE SAW TO CUT THRU THE FLOORMAT (IF SUPPLIED). DRILL THRU THE VEHICLE FLOOR USING 1/2" DIAMETER DRILL BIT WITH STOP.

APPLY PRIMER TO ALL RAW SHEET METAL EDGES. INSERT AND SET THE FOUR (4) PLUSNUTS.







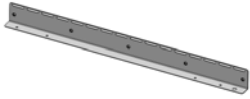

PARTS YOU WILL USE FOR STEP 03	SMALL FLAT BLADE SCREWDRIVER			
				

Instructions for Step 03

REMOVE UPPER OEM LINER AND MOUNTING BRACKET (SHOWN REMOVED)



IF THE VEHICLE HAS AN OEM LINER KIT INSTALLED, REMOVE THE STREETSIDE FRONT UPPER PANEL AND THE MOUNTING BRACKET AS SHOWN.

PARTS YOU WILL USE FOR STEP 04	49908-B, FOOTER RAIL (1) EACH	FAS0711, SPRING CLIPS (2) EACH	03927-1 FLOOR SPACER (4) EACH	FAS0095, 5/16X2" HEX CAP SCREWS (4) EACH
				
	FAS0098, 5/16" LOCK WASHERS (4) EACH	FAS0552, 5/16" FLAT WASHERS (4) EACH	DRILL/DRIVER	1/2" SOCKET
				

Instructions for Step 04

ATTACH TWO SPRING CLIPS TO THE FOOTER RAIL IN THE 4TH AND 9TH SLOTS FROM THE CURBSIDE END AS SHOWN.

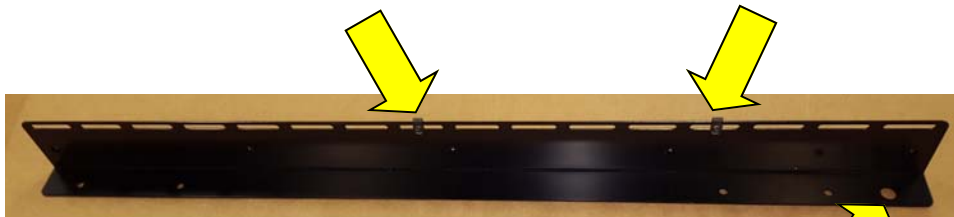

CURBSIDE END IDENTIFICATION HOLE.

ATTACH TWO SPRING CLIPS TO THE FOOTER RAIL WITH THREADED PORTION FACING ON THE FLANGE SIDE OF THE FOOTER RAIL AS SHOWN.

PLACE THE FOUR (4) FLOOR SPACERS OVER THE PLUSNUTS AND FASTEN THE FOOTER RAIL TO THE VEHICLE AS SHOWN USING THE 5/16" BOLTS, LOCKWASHERS AND FLAT WASHERS.



ATTACH THE FOOTER RAIL TO THE VEHICLE AS SHOWN.

CURBSIDE END IDENTIFICATION HOLE.

PARTS YOU WILL USE FOR STEP 05	1/2" DIA. DRILL BIT WITH STOP 	DRILL 	PRIMER 	FAS0091 5/16-18 PLUSNUT (2) EA 
	PLUSNUT GUN OR SETTING TOOL 			

Instructions for Step 05



LOCATE THE TWO (2) STREETSIDE B-PILLAR OEM HOLES AS IDENTIFIED. IF THE VEHICLE HAS M6 METRIC WELD NUTS INSTALLED IN THE POSITIONS THEN YOU WILL SKIP THIS STEP.

IF THE TWO HOLE LOCATIONS DO NOT HAVE WELD NUTS INSTALLED YOU WILL ENLARGE THE HOLES IN THE B-PILLAR AS SHOWN USING 1/2" DIAMETER DRILL BIT WITH STOP.

APPLY PRIMER TO THE DRILLED EDGES.

INSERT AND SET THE TWO (2) 5/16" PLUSNUTS AS SHOWN.

PARTS YOU WILL USE FOR STEP 06 A	1/2" DIA. DRILL BIT WITH STOP 	DRILL 	PAINT MARKER or CENTER PUNCH 	PRIMER 
	FAS0091 5/16-18 PLUSNUT (5) EA 	PLUSNUT GUN OR SETTING TOOL 		
Mid roof				

Instructions for Step 06 A -Mid roof



TEMPORARILY POSITION THE PARTITION PANEL AS SHOWN INTO THE VEHICLE AGAINST THE B-PILLAR ROOF BOW (OR USE A PREVIOUSLY VALIDATED DRILL JIG) AND MARK THE FIVE (5) HOLE LOCATIONS IN THE B-PILLAR ROOF BOW AS SHOWN. REMOVE THE PARTITION PANEL AND USING 1/2" DIAMETER DRILL BIT WITH STOP DRILL THE FIVE (5) MOUNTING HOLES.



APPLY PRIMER TO ALL RAW SHEET METAL EDGES.

INSERT AND SET THE FIVE (5) 5/16" PLUSNUTS AS SHOWN.

PARTS YOU WILL USE FOR STEP 06 B	1/2" DIA. DRILL BIT WITH STOP 	DRILL 	PAINT MARKER or CENTER PUNCH 	PRIMER 
	FAS0091 5/16-18 PLUSNUT (4) EA 	PLUSNUT GUN OR SETTING TOOL 		
High roof				

Instructions for Step 06 B-High roof



TEMPORARILY POSITION THE PARTITION PANEL AS SHOWN INTO THE VEHICLE AGAINST THE B-PILLAR ROOF BOW (OR USE A PREVIOUSLY VALIDATED DRILL JIG) AND MARK THE FOUR (4) HOLE LOCATIONS IN THE B-PILLAR ROOF BOW AS SHOWN. REMOVE THE PARTITION PANEL AND USING 1/2" DIAMETER DRILL BIT WITH STOP DRILL THE FOUR (4) MOUNTING HOLES.

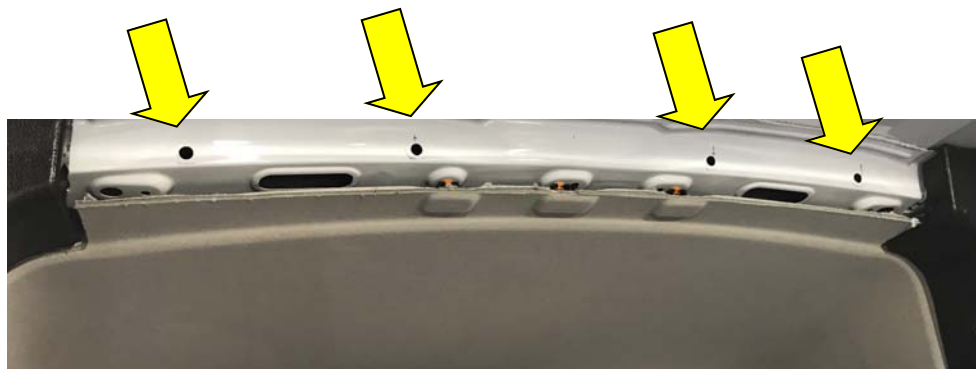

APPLY PRIMER TO ALL RAW SHEET METAL EDGES.

INSERT AND SET THE FOUR (4) 5/16" PLUSNUTS AS SHOWN.

PARTS YOU WILL USE FOR STEP 07	51778-B, CS MTG BRKT (1) EACH	FAS0187 SCREW, HH M6-1X22 SS (2) EACH	FAS0066 1/4" LOCKWASHER (2) EACH
			
	DRILL/DRIVER	3/16" HEX DRIVER BIT	
			





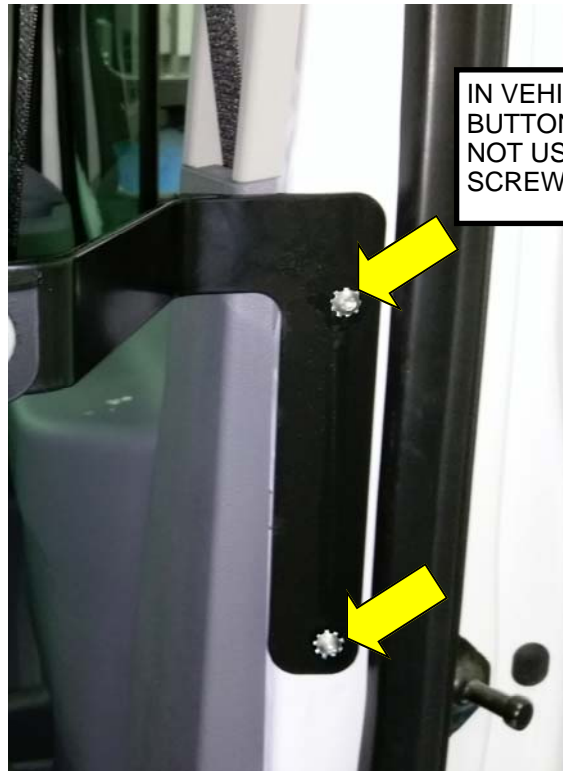
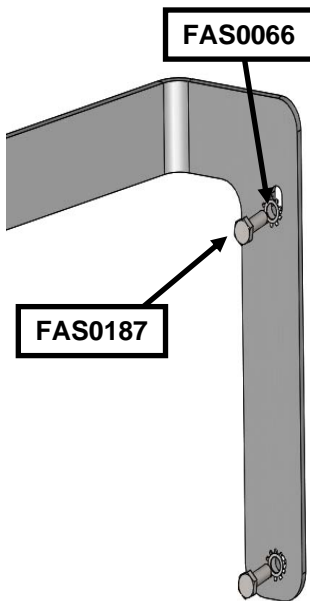

Instructions for Step 07

ATTACH CURBSIDE MOUNTING BRACKET AS SHOWN.



IN VEHICLE POSITION SHOWS BUTTON HEAD FASTENER, DO NOT USE! USE FAS0187 HH M6 SCREW AS SHOWN IN 3D MODEL.

ATTACH THE CURBSIDE MOUNTING BRACKET TO THE B-PILLAR AS SHOWN. SECURE USING HH M6 1X22 SS FASTENERS AND 1/4" LOCK WASHERS AS SHOWN.

PARTS YOU WILL USE FOR STEP 08	51779-B, SS MTG BRKT (1) EACH	FAS0708 BHCS 5/16X1.25 (2) EACH	FAS033 BHCS M6X1.0 (2) EACH	FAS0552, 5/16" FLAT WASHERS (2) EACH
			OR	
	FAS0085 5/16" LOCKWASHER (2) EACH	FAS0066 1/4" LOCKWASHER (2) EACH	DRILL/DRIVER	3/16" OR M6 HEX DRIVER BIT
		OR		
				

Instructions for Step 08

ATTACH STREETSIDE MOUNTING BRACKET AS SHOWN.



ATTACH THE STREETSIDE MOUNTING BRACKET TO THE B-PILLAR AS SHOWN. SECURE.

IF THE B-PILLAR INCLUDES OEM WELD NUTS, USE THE METRIC M6 FASTENERS AND 1/4" LOCKWASHERS. IF YOU HAVE INSTALLED 5/16 PLUSNUTS, USE THE 5/16" FASTENERS, 5/16" LOCK WASHERS AND FLAT WASHERS AS SHOWN.

PARTS YOU WILL USE FOR STEP 09	51777-B CROSS CHANNEL ASSM., (1) EACH 	FAS0711, SPRING CLIPS (2) EACH 	FAS0248, 5/16" LOCK NUT (4) EACH 	FAS0552, 5/16" FLAT WASHERS (4) EACH 
	DRILL/DRIVER 	1/2" SOCKET 		

Instructions for Step 09

ATTACH TWO SPRING CLIPS TO THE FOOTER RAIL IN THE 4TH AND 9TH SLOTS FROM THE CURBSIDE END AS SHOWN.

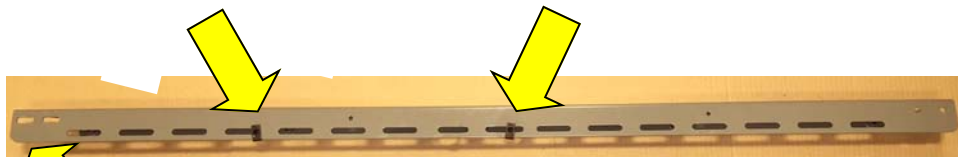

CURBSIDE END IDENTIFICATION SLOTS.



ATTACH THE CROSS CHANNEL TO THE STREETSIDE BRACKET AS SHOWN.







ATTACH THE CROSS CHANNEL TO THE CURBSIDE BRACKET AS SHOWN.

ATTACH TWO SPRING CLIPS TO THE CROSS CHANNEL AS SHOWN WITH THREADED PORTION TOWARDS THE INSIDE OF THE CHANNEL.

POSITION THE CROSS CHANNEL OVER THE CURBSIDE AND STREETSIDE MOUNTING BRACKET STUDS AS SHOWN.

ATTACH THE CROSS CHANNEL TO THE MOUNTING BRACKETS (PLUSNUTS SHOULD BE FACING TOWARDS BACK OF VEHICLE) USING THE 5/16" FLAT WASHERS AND LOCKNUTS AS SHOWN- AND TIGHTEN FASTENERS.

PARTS YOU WILL USE FOR STEP 10	51782-B ACC. MTG. CHANNEL (2) EACH	FAS0018 1/4X5/8 HH SFLG SCRW (4) EACH	DRILL/DRIVER	7/16" SOCKET
				

Instructions for Step 10

ATTACH ACCESSORY MOUNTING CHANNELS AS SHOWN.



NOTE: LARGE FLANGE ORIENTATION IS OPTIONAL FOR MOUNTING ACCESSORIES.



ATTACH TWO ACCESSORY MOUNTING CHANNELS TO THE FOOTER AND CROSS CHANNEL AS SHOWN.

POSITION THE MOUNTING CHANNELS OVER THE FRONT FACE (CAB SIDE) OF THE FOOTER AND CROSS CHANNEL WITH THE MOUNTING CHANNELS J-LEGS FACING REARWARD.

ATTACH THE CHANNELS USING 1/4 FLANGE SCREWS AND FASTEN INTO THE SPRING CLIPS AS SHOWN AND TIGHTEN.

<p>PARTS YOU WILL USE FOR</p> <p>STEP 11</p>	<p>CCD6</p>			
	<p>THIS PRODUCT AND ASSOCIATED PARTS ARE NOT INCLUDED IN THIS KIT!</p>			

Instructions for Step 11 Supplemental

ATTACH STREETSIDE MOUNTING BRACKET AS SHOWN.

STEP 09a

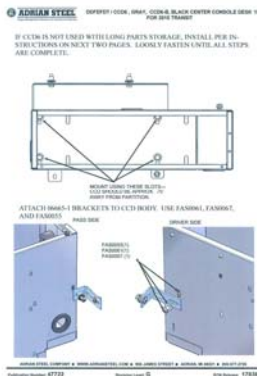

STEP 09b



STEP 09c

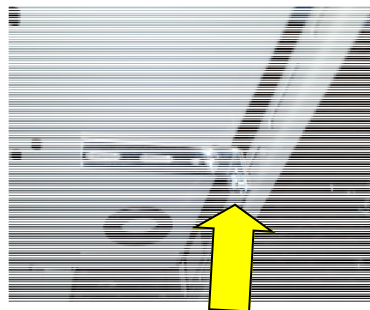

NOTE:
SKIP THIS STEP IF YOU ARE NOT INSTALLING A CCD6 CENTER CONSOLE!

STEP 09a



FOLLOW THE INSTRUCTIONS FOR THE CCD6 INSTALLATION UP TO THE INSTALLATION OF THE 06665-1 BRACKETS.

STEP 09b

USING THE FASTENERS AND 06665-1 BRACKET FROM THE CCD6 HARDWARE KIT FOLLOW THE INSTRUCTIONS FOR MOUNTING THE BRACKET TO THE CCD6 ON THE STREETSIDE OF THE CENTER CONSOLE.

STEP 09c

PUSH BRACKET TO BE TIGHT AGAINST THE ACCESSORY MOUNTING CHANNEL AND FASTEN USING FAS0062, FAS0067 AND FAS0055 FROM THE CCD6 KIT, FULLY TIGHTEN ALL OF THE FASTENERS.

PARTS YOU WILL USE FOR STEP 12	51770 PARTITION PANEL ASSM., SOLID	51774 PARTITION PANEL ASSM. W/WINDOW,	51784 LOWER SEAL (2) EACH	51785 UPPER SEAL (2) EACH	
		OR			
	SMALL RUBBER MAL- LET				
					

Instructions for Step 12

ATTACH BULB SEALS TO PARTITION AS SHOWN.

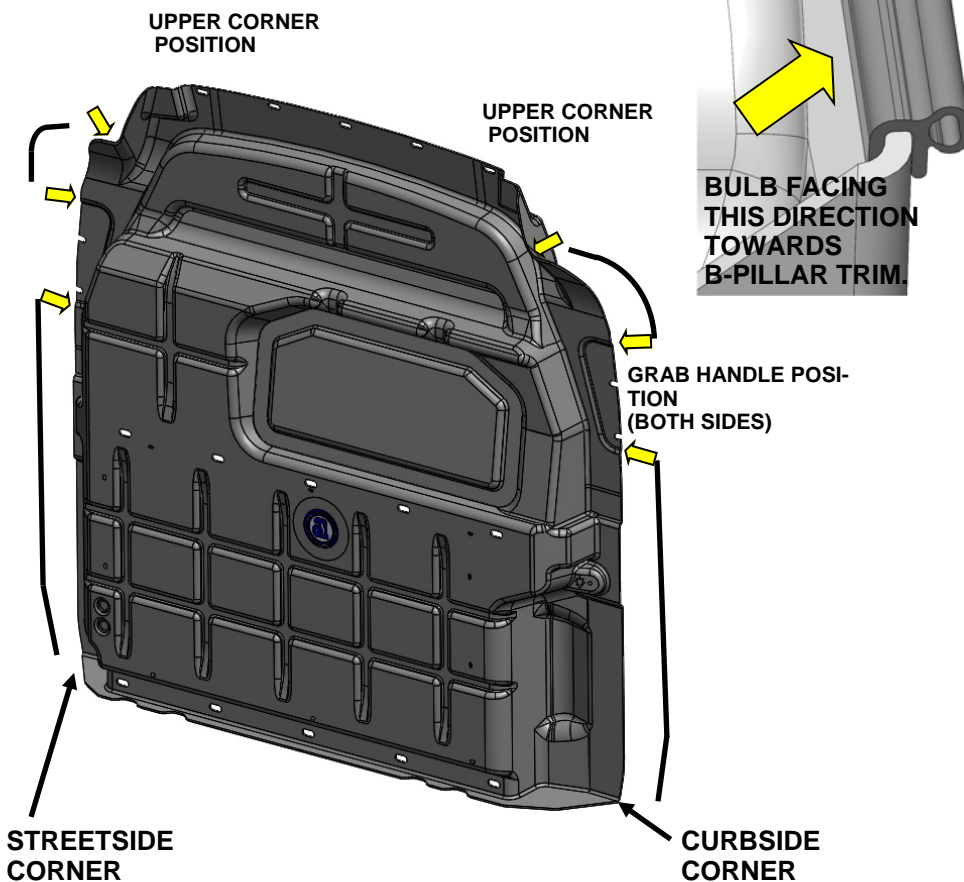



NOTE: BULB PORTION OF THE SEALS SHOULD BE FACING TOWARDS THE B-PILLAR!

ATTACH 51784 LOWER SEALS TO THE BOTTOM PARTITION OF THE PANEL STARTING AT THE BOTTOM CORNERS AND WORKING UP TO THE LOWER SIDE OF THE GRAB HANDLE POSITION ON BOTH SIDES.

TRIM OFF EXCESS SEAL IF NEEDED.

ATTACH 51785 UPPER-SEALS STARTING AT THE UPPER SIDE OF THE GRAB HANDLE POSITION AND WORKING UP TO THE UPPER CORNERS AS SHOWN.

TRIM OFF EXCESS SEAL IF NEEDED.

PARTS YOU WILL USE FOR STEP 13	PARTITION PANEL ASSEMBLIES WITH BULB SEALS INSTALLED		
		OR	

Instructions for Step 13

INSERT PARTITION PANEL INTO VEHICLE.

INSERT TOP FIRST THEN PIVOT FORWARD AND INTO PLACE AGAINST FOOTER.

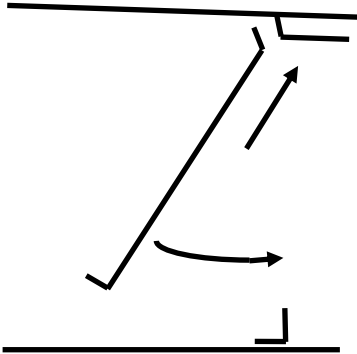

INSERT PARTITION INTO VEHICLE WITH BOTTOM EDGE WAY FROM THE FOOTER WITH THE TOP CONTACTING THE HEADER AREA FIRST AND THEN PIVOT UP AND FORWARD INTO PLACE AGAINST B-PILLARS AND FOOTER.

PARTS YOU WILL USE FOR STEP 14	OEM GRAB HANDLE(S) FROM STEP 01	OEM FASTENERS FROM STEP 01	10MM SOCKET	
				

Instructions for Step 14

RE-ATTACH OEM GRAB HANDLE AS SHOWN.



ENSURE THAT THE PARTITION PANEL IS CENTERED IN VEHICLE AND THAT MOUNTING SLOTS AND HOLES ARE ALIGNED.

LOCATE OEM GRAB HANDLE(S) AND FASTENERS (REMOVED IN STEP 01).

ATTACH THE CURBSIDE AND STREETSIDE (IF STREETSIDE CARGO DOOR IS PRESENT) GRAB HANDLE(S) TO PARTITION (CURBSIDE SHOWN) USING THE OEM FASTENERS.

PARTS YOU WILL USE FOR STEP 15	50941-B RAIL AD, PARFTL	36496-0 END CAP (2) EACH	FAS0708 BHCS 5/16X1-1/4 (5) EACH	FAS0085 5/16 LOCK WASHER (5) EACH
				
	DRILL/DRIVER	3/16" HEX DRIVER BIT	SMALL RUBBER MALLET	
				

Instructions for Step 15

ATTACH AD RAIL TO PARTITION AS SHOWN.

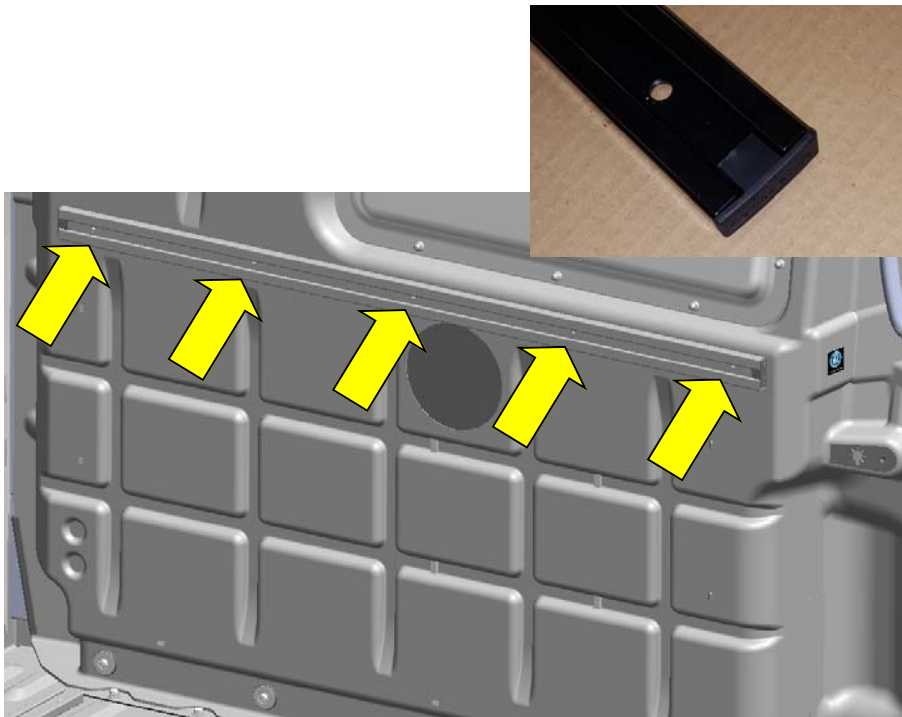

INSERT A PLASTIC END CAP INTO EACH END OF THE AD RAIL AS SHOWN

ATTACH THE AD RAIL AND PARTITION PANEL TO THE CROSS CHANNEL USING THE ABOVE LISTED 5/16" FASTENERS AT FIVE (5) PLACES AS SHOWN.

NOTE: DO NOT FULLY TIGHTEN THESE FIVE (5) FASTENERS AT THIS STEP!

ADJUSTMENTS MAY BE NEEDED DURING THE NEXT STEP!

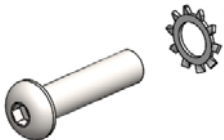

PARTS YOU WILL USE FOR STEP 16	FAS0708 BHCS 5/16X1-1/4 (5) EACH	FAS0085 5/16 LOCK WASHER (5) EACH	FAS0833 WASHER, CUP (5) EACH	FAS0253 WASHER, IV-2 (5) EACH
				
	DRILL/DRIVER	3/16" HEX DRIVER BIT		
				

Instructions for Step 16

ATTACH PARTITION PANEL AS SHOWN.

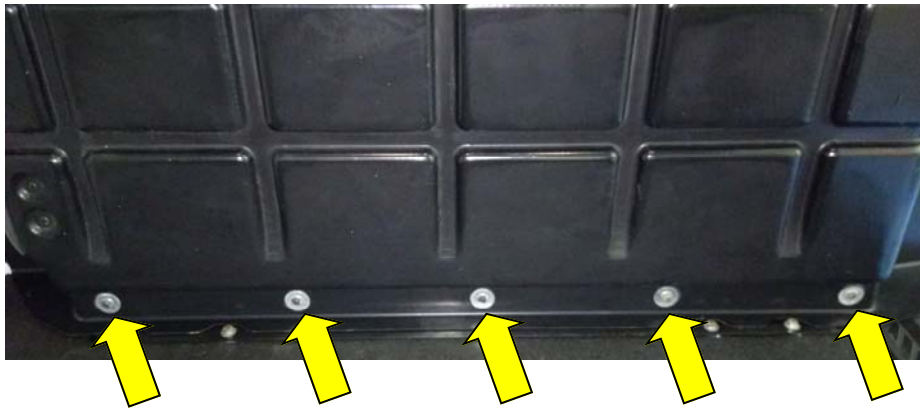

ATTACH THE PARTITION PANEL TO THE PARTITION FOOTER USING THE ABOVE LISTED 5/16" FASTENERS, WASHERS AND GASKETS AT FIVE (5) PLACES AS SHOWN. FULLY TIGHTEN THESE FIVE (5) FASTENERS.

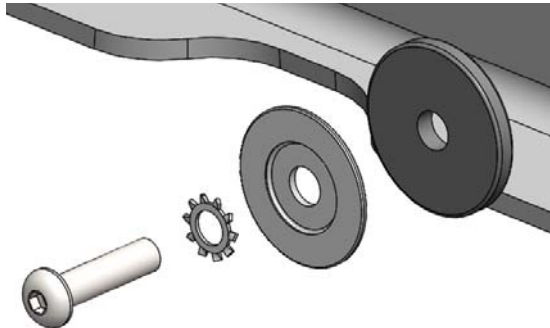

PARTS YOU WILL USE FOR STEP 17	FAS0708 BHCS 5/16X1-1/4 (5) EACH	FAS0085 5/16 LOCK WASHER (5) EACH	FAS0833 WASHER, CUP (5) EACH	FAS0253 WASHER, IV-2 (5) EACH
				
	DRILL/DRIVER	3/16" HEX DRIVER BIT		
				

Instructions for Step 17

ATTACH PARTITION PANEL AS SHOWN.



ATTACH THE PARTITION PANEL TO ROOF-BOW USING THE ABOVE LISTED 5/16" FASTENERS, WASHERS AND GASKETS AT FIVE (5) PLACES AS SHOWN. FULLY TIGHTEN THESE FIVE (5) FASTENERS.

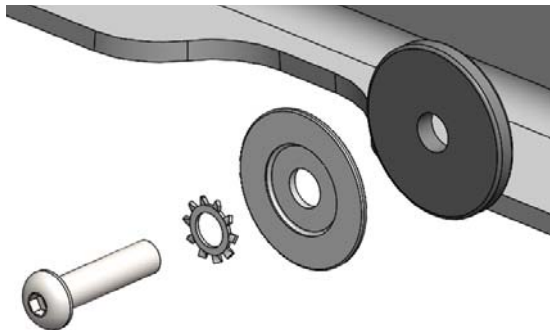

PARTS YOU WILL USE FOR STEP 18	DRILL/DRIVER	3/16" HEX DRIVER BIT		
				

Instructions for Step 18

TIGHTEN AD RAIL FASTENERS.

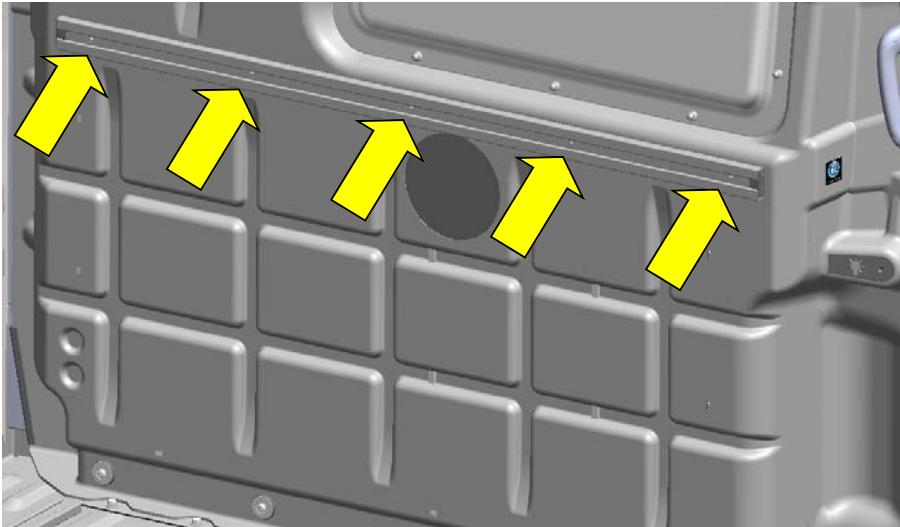

FULLY TIGHTEN THE FIVE (5) FASTENERS THAT ATTACH THE AD RAIL.

PARTS YOU WILL USE FOR	PARHDW OPTIONAL KIT	DRILL/DRIVER	7/16" SOCKET	
<p style="text-align: center; font-size: 2em; font-weight: bold;">STEP 19</p>				

Instructions for Step 19 Supplemental

NOTE:
IT IS ACCEPTABLE TO INSTALL ACCESSORIES THAT WEIGH LESS THAN 15 POUNDS DIRECTLY TO THE CARGO-SIDE OF THE PARTITION PANEL.

YOU MUST ORDER HARDWARE KIT(S) PARHDW FOR THE CORRECT FASTENERS

FIRE EXTINGUISHER SHOWN FOR EXAMPLE.

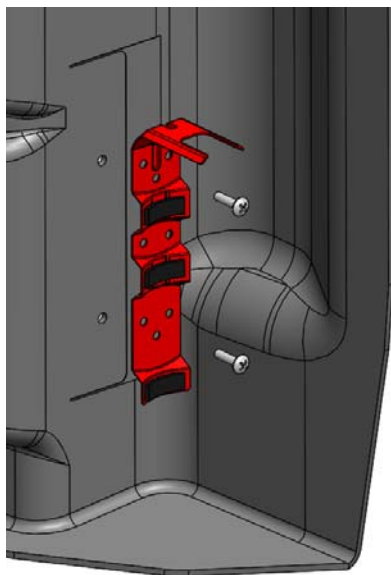

DETERMINE MOUNTING POSITION FOR ACCESSORY AND MARK HOLE LOCATION(S). DRILL 5/16" DIAMETER HOLES THRU PARTITION PANEL. USE 1/4" TRUSS HEAD SCREWS THRU THE ACCESSORY WITH CUP WASHERS FROM THE CAB SIDE OF THE PARTITION AND USE NYLOCK FLANGE NUTS TO SECURE ACCESSORY.

NOTE:
FOR MOUNTING ACCESSORIES TO THE CAB SIDE OF THE PARTITION PANEL THE MOUNTING RAILS INCLUDED WITH THE PARTITION SHOULD BE USED. ADDITIONAL RAILS CAN BE ORDERED WITH **PARCAB** MOUNTING KIT.

FOR MOUNTING HEAVIER AND/OR BULKY ACCESSORIES TO THE CARGO SIDE OF THE PARTITION THE ACCESSORY MOUNTING KIT **PARFTCRG** SHOULD BE ORDERED AND INSTALLED.