

**CATALOG NUMBER HD-32NV2****PRODUCT APPLICATION**

**THIS SHELVING UNIT IS DESIGNED FOR THE NISSAN NV200 COMMERCIAL VEHICLE. THE SHELVING MAY APPLY TO OTHER VEHICLE APPLICATIONS (CONTACT ADRIAN STEEL TO CONFIRM)**

**ACCESSORIES THAT WILL WORK WITH THIS PRODUCT**

<b>CATALOG NUMBER</b>	<b>DESCRIPTION</b>
DC6	6" DRAWER UNIT
DC12	12" DRAWER UNIT
DV12	DIVIDERS
DK32TC	DOOR KIT

**SPECIAL APPLICATION NOTES****NONE.**

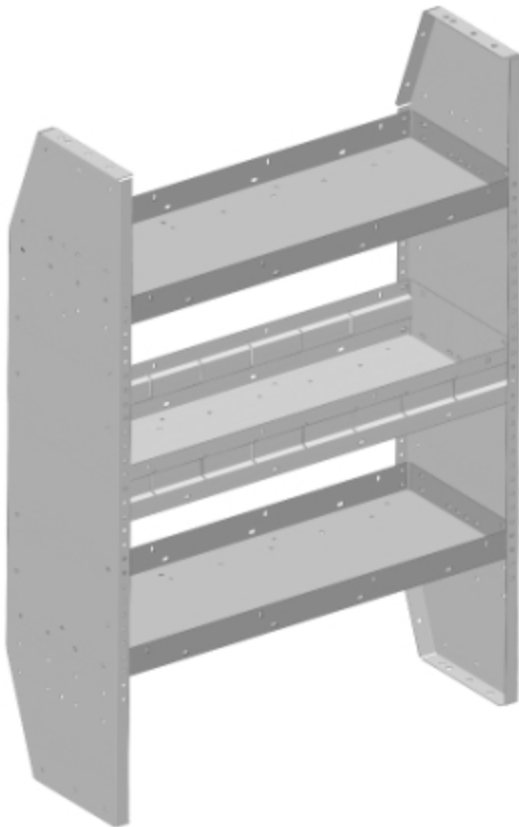
**PRODUCT WEIGHT****46 LBS.****WIDTH x DEPTH x HEIGHT****32 x 12 x 46****CAPACITY****2" SHELF = 50 LBS.  
4" SHELF = 130 LBS.****COLOR****GRAY****CATALOG NUMBER****HD-32NV****PRODUCT FEATURES**

**HEAVY DUTY ADJUSTABLE SHELVING UNIT WITH TWO (2) EACH 12" X 32" X 2" SHELVES AND ONE (1) EACH 12" x 32" x 4" HEAVY DUTY SHELF. THE SHERLVES CAN BE ADJUSTED USING THE MOUNTING HOLES THAT ARE ON 1" CENTERS.**

**SEE PAGE 2 FOR APPLICATION NOTES AND ACCESSORIES, OTHER PRODUCTS THAT WORK WITH THIS UNIT.**

**PAGE 1 of 2**

The information contained in this document is the sole property of ADRIAN STEEL COMPANY. ADRIAN STEEL COMPANY retains the right to modify and/or change the product of its design at any time without prior notification.



**ADRIAN STEEL®**

*Cargo Management Solutions for Commercial Vehicles*

## Assembly/Installation Instructions and Owners Manual

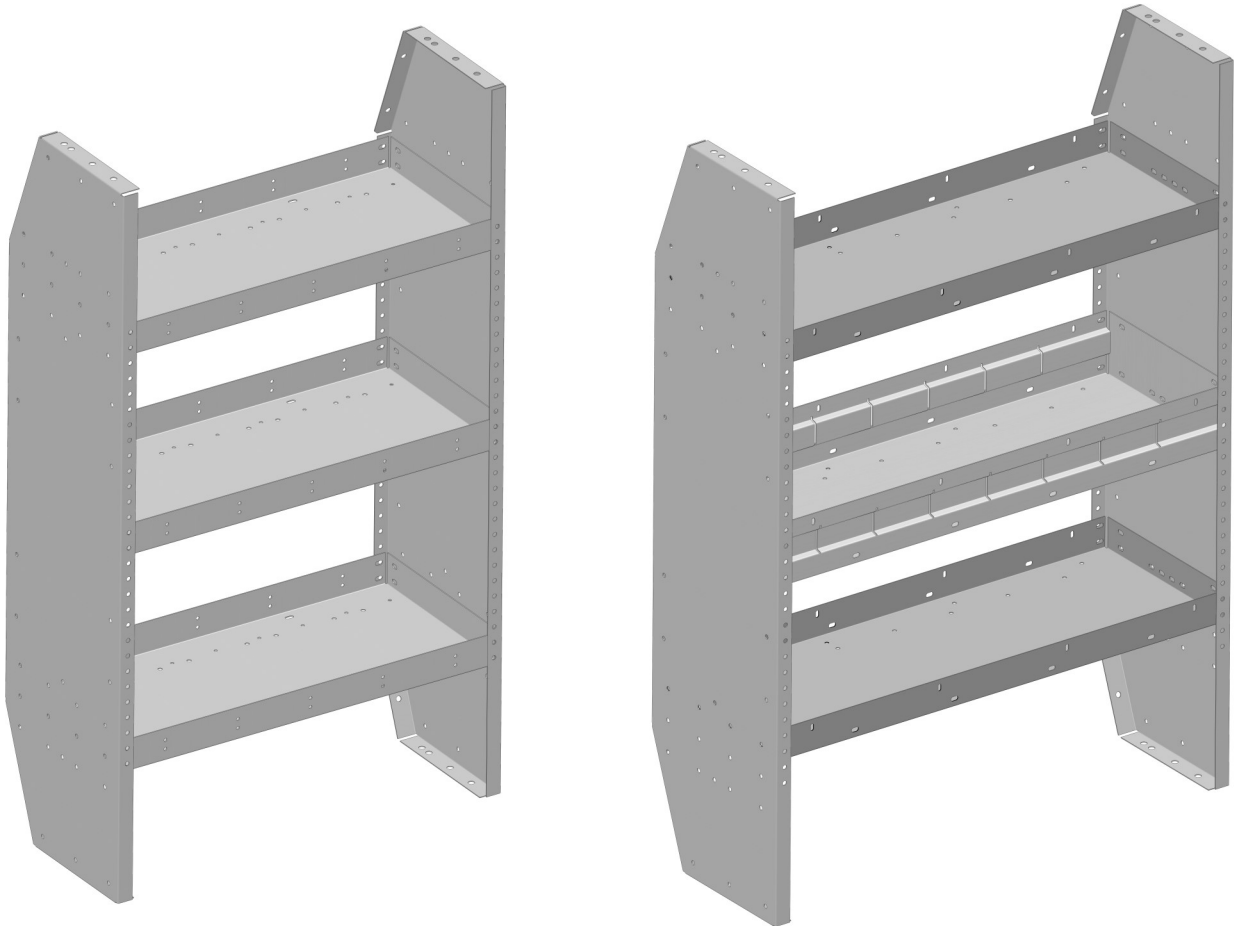

### **HD26NV2 & HD32NV2 HD SHELVING UNITS**

## - PRECAUTIONS -





 **CAUTION**   
**THE USE AIR IMPACT TOOLS CAN  
OVER-TORQUE FASTENERS AND  
CAUSE FASTENER FAILURE!**



 **CAUTION**   
**ALL INSTALLATION HOLES SHOULD BE SEALED  
WITH SILICON OR BUTYL SEALANT TO PREVENT  
EXHAUST FUMES FROM ENTERING THE VEHICLE!**



 **DANGER**   
**INSPECT FOR FUEL TANK, FUEL LINES, BRAKE LINES, HIGH  
VOLTAGE BATTERIES AND ELECTRICAL LINES PRIOR TO  
DRILLING TO AVOID DAMAGING CRITICAL VEHICLE SYSTEMS  
OR INJURY TO INSTALLER DURING INSTALLATION PROCESS!**



 **CAUTION**   
**TO AVOID DAMAGING THE VEHICLE ALWAYS  
USE DRILL STOPS WHEN DRILLING ANY IN-  
STALLATION HOLES!**



## - IMPORTANT WARRANTY REQUIREMENTS -

1. SUBSTITUTING ADRIAN STEEL SPECIFIED FASTENERS FOR ASSEMBLY AND/OR INSTALLATION WILL VOID YOUR PRODUCT WARRANTY.
2. ALL HOLES DRILLED INTO VEHICLE SHOULD HAVE THE RAW METAL EDGES SEALED WITH A SELF-ETCHING PRIMER TO RESIST CORROSION AND POTENTIAL FASTENER POINT FAILURE.
3. ALL FASTENERS USED IN THE INSTALLATION OF THIS PRODUCT SHOULD BE TIGHTENED TO THE TORQUE(S) SPECIFIED IN THESE INSTRUCTIONS.
4. THESE INSTRUCTIONS SHOULD BE KEPT WITH THE VEHICLE.

### THE BASIC TOOLS NEEDED FOR MOST INSTALLATIONS



DRILL



DRILL BIT WITH  
STOP

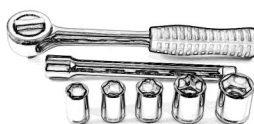

RATCHET, SOCKETS  
AND/OR WRENCHES



SCREWDRIVERS





MEASURING TAPE

ADDITIONAL TOOLS MAY BE NEEDED FOR THIS INSTALLATION AND THEY WILL BE IDENTIFIED IN THE STEPS THAT FOLLOW.

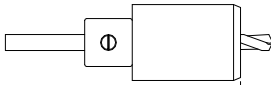

**WHEN INSTALLING PLUSNUTS MAKE SURE YOU USE THE CORRECT DRILL BIT WITH A STOP!**

PLUSNUT SIZE	DRILL BIT SIZE
1/4-20 PLUSNUT, FAS0052	USE A 3/8" DIAMETER DRILL BIT WITH A STOP.
5/16-18 PLUSNUT, FAS0091	USE A 1/2" DIAMETER DRILL BIT WITH A STOP.
 OR  NOTE: A PLUSNUT SETTING TOOL IS REQUIRED FOR PLUSNUT INSTALLATION AND IS NOT SUPPLIED WITH THIS KIT. ORDER PLUSNUT TOOLS FROM ADRIAN STEEL (P.N. 22200-0) OR USE AN AIR POWERED PLUSNUT SETTING GUN.	
NOTE: If your vehicle contains carpet or a rubber floor mat you will need to prepare the mounting locations using a 1-3/16" carpet cutter.	1-3/16" DIAMETER CARPET CUTTER P.N. 31183-0. 

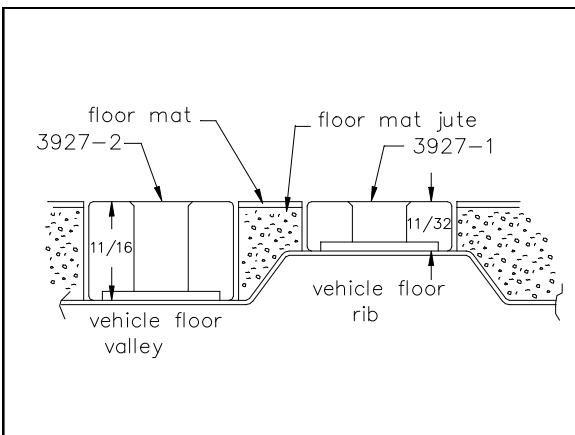

**Step 01**  
**Optional Based on Vehicle**

If your vehicle contains carpet or a rubber floor mat you will need to prepare the mounting locations. **(if not, skip to STEP 02)**

Position the product to be installed into the vehicle and once you are satisfied with the mounting locations, mark the mounting locations. Using a 1-3/16" diameter carpet cutter. Select the appropriate floor spacers as shown in the illustration to the left. Set those aside for use later into the installation process.

Once you have prepared the carpet/floor mat for mounting, proceed to **STEP 02**.

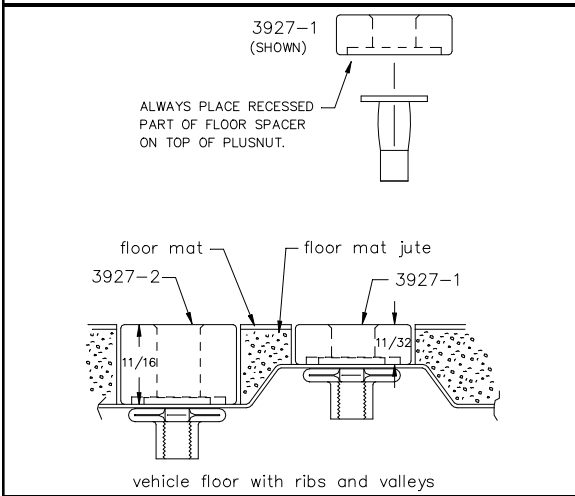

**Step 02**  
**Prepare Mounting Locations**

Using a drill and drill bit (see table at top of page for correct size) drill the mounting holes in the vehicle sheet metal to prepare for installing the plusnuts.

If you are thru-bolting at any of the locations simply drill a hole that is 1/16" larger than the bolt size(s) for those locations.

Once you have drilled the holes into the vehicle, the raw metal edges should be sealed using a self-etching primer to resist corrosion and potential fastener point failure.

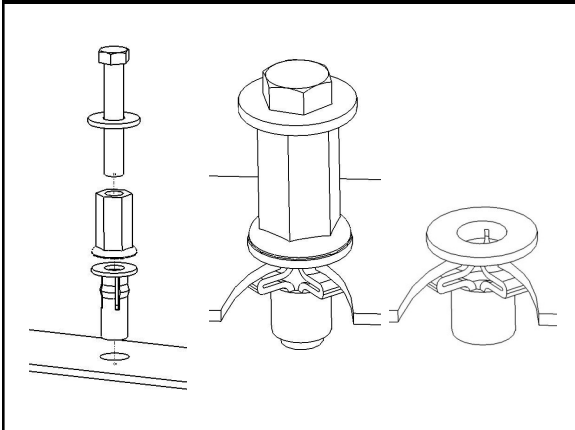

**Step 03**  
**Setting Plusnuts**

Use a Air Powered Plusnut Setting Gun to "set the plusnut" or if installing manually with hand tools, assembly the following.



**1/4-20UNC Plusnut (FAS0052)**  
FAS0080 SCREW, HXHD, 1/4-20UNCx2.00, G8  
FAS0067 WASHER, FLAT, 1/4"ID  
22200-0 PLUSNUT TOOL

**5/16-18UNC Plusnut (FAS0091)**  
FAS0095 SCREW, HXHD, 5/16-18UNCx2.00", G8  
FAS0086 WASHER, FLAT, 5/16"ID  
22200-0 PLUSNUT TOOL

Place barrel of the plusnut body in sheet metal thru hole until flange is flush with sheet metal.

Using a 9/16" combination wrench of plusnut tool body and a second hand wrench, ratchet, or air tool, rotate the hex bolt head CW to draw plus nut flanges up (set the plusnut).

Remove hex bolt, washer, and plusnut. Inspect installation.

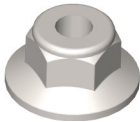
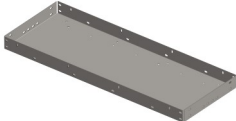
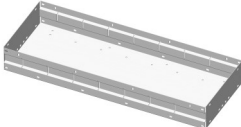
<p><b>PARTS YOU WILL USE FOR</b></p> <p><b>STEP 04</b></p>	<p><b>HD26NV2 &amp; HD32NV2</b> EP1246NV2, END PANELS (2) REQUIRED</p> 	<p><b>HD26NV2</b> SF1226, SHELF (3) REQUIRED</p> 	<p><b>HD26NV2 &amp; HD32NV2</b> FAS0061, 1/4-20X.5 THP (24) REQUIRED</p> 	<p><b>HD26NV2 &amp; HD32NV2</b> FAS0055, 1/4-20 NYLK NUT (24) REQUIRED</p> 
	<p><b>HD32NV2</b> SF21232, SHELF (2) REQUIRED</p> 	<p><b>HD32NV2</b> SF41232, SHELF (1) REQUIRED</p> 		

# Instructions for Step 04

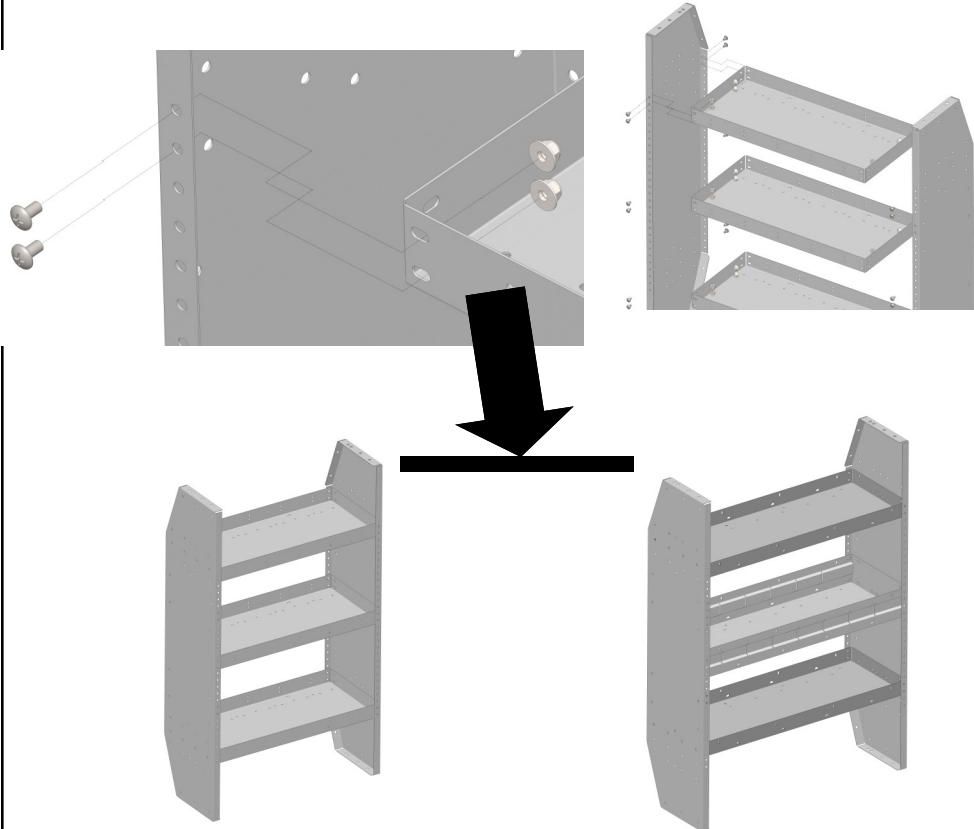

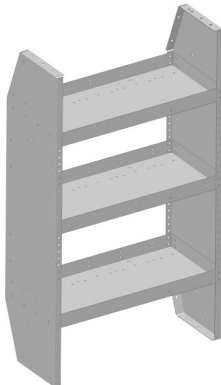

HD26NV2

**COMPLETED STEP**

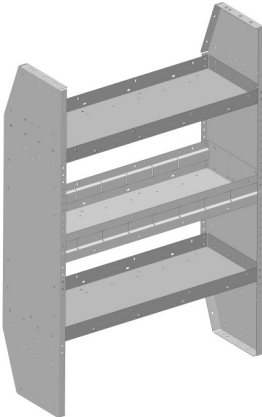

HD32NV2

Determine the shelf positions for your installation and position the shelves to the end panels accordingly. Fastener the shelves to the end panels using two (2) each THP screws and the nylock nuts at each corner to secure the shelf flanges to the end panel flanges as shown.

Ensure that the end panels are square to the shelves and fully tighten all of the fasteners.

For installing the shelves to the rail mounting kits in the vehicle refer to the installation instructions for the corresponding rail kits.

# STEP 05 (Optional)

## Add utility hooks

