

**Introduction / Comments:**

Install Instructions For Exterior Plug & Play Lights For RAM Truck

**Note:**

Read all instructions prior to installation. Review the Adrian Steel **GENERAL PRECAUTIONS PAGES (56638)** before attempting installation. Only personnel familiar with using electrical best practices should perform this install. Reference **ELECTRICAL BEST PRACTICES MANUAL (54479)** before attempting installation.



**Installation Instructions For Exterior Plug And Play Lights For RAM Truck**

## Table of Contents:

Torque requirements.....	2
Best Practice for Routing Through the Firewall.....	3
Introduction Statement.....	4
Overall Harness Diagram.....	4
Tools needed.....	4
Harnesses/Components Needed (If Applicable).....	5
Component Placements.....	6
Overall Harness Routing.....	7
Beginning Install.....	8
Strobe Installation Instructions.....	8

**\*\*\*TORQUE\*\*\***  
**Torque all strobe fasteners to 10 in-lbs.**  
**DO NOT OVER TIGHTEN**

**DO NOT MOUNT ON A CURVED SURFACE**

## Best Practices to Follow when Routing Through Firewall:

- Create a drip loop with the harness being routed through the firewall as shown so that the water does not flow into the grommet.
- Make sure that the proper grommet for the hole being routed through is used so that there are no openings for water to get through.
- Use silicone after routing and apply around the grommet and wire to seal it. Make sure to let the silicone dry for 30 minutes to an hour.

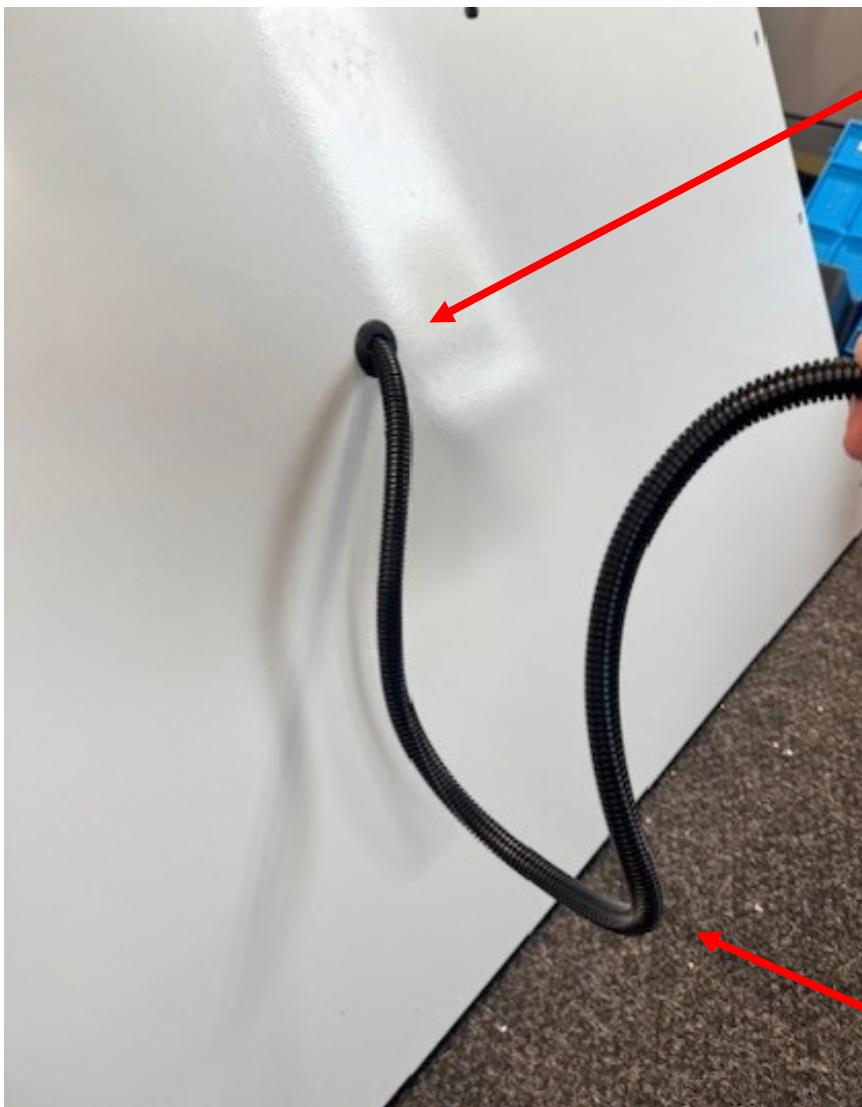

Apply silicone around the grommet and wire loom so that it is completely sealed.

Drip loop created so water runs off of loom and not into the cab of the vehicle.

**\*\*Please read statement below before moving forward\*\***

**Before installation, disconnect the OEM negative battery cable.**

These plug and play kits are completely modular and can be configured in many different ways. Placement of lights will be determined by sales order drawings/customer ask. Therefore, these instructions are for the most standard configurations, and for reference only.

Please reference the order drawing and spec sheet to see what components are going to be installed on this particular upfit.

**These installation instructions are for most cases and for reference. Not all installs will have strobes, beacons, and lightbars. Reference the instructions for only what you are installing.**

## Overall Harness Diagram

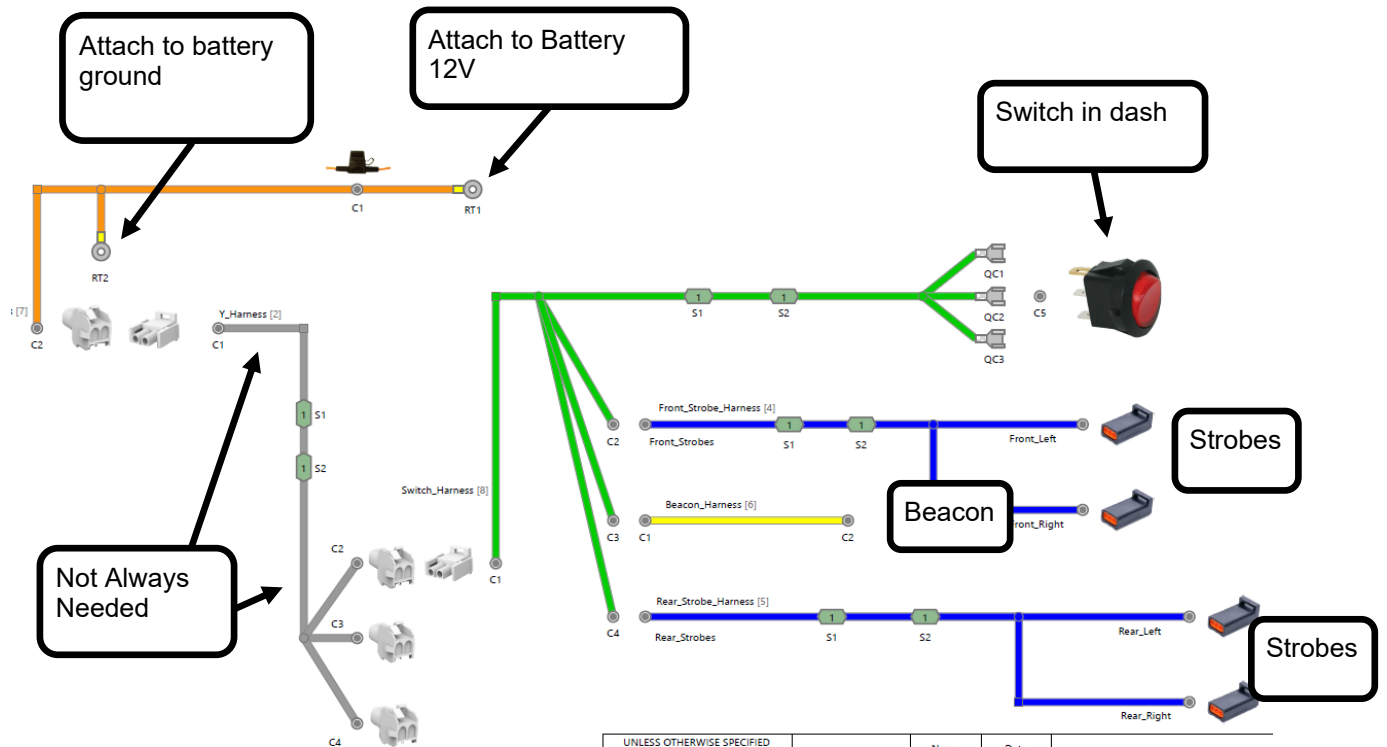

### Tools required:

10mm socket

Phillips bit and 5/16" step drill bit

Power drill and impact

Torque wrench

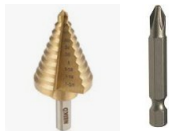

## Components

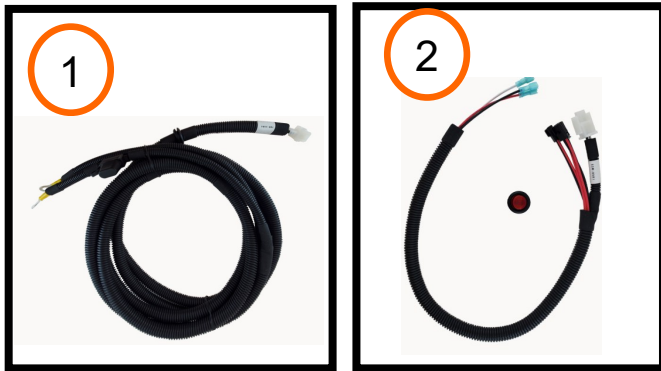

	Part Number	Description
1	67095	Power Harness #4
2	67097	Switch Harness #1
3	67102	Front Strobe Harness #2 (If Applicable)
4	67107	Rear Strobe Harness #2 (If Applicable)
5	67113	Beacon/Lightbar Harness #3 (If Applicable)
6	67686 or 67687	Strobes (If Applicable)
7	67689 or 67690	Beacons (If Applicable)
8	52769 or 56075	Beacon/Lightbar Mount (If Applicable)
9	67691 or 67692 or 96118 or 67693	Lightbars (If Applicable)



The purpose of plug and play lighting is to be completely modular. Due to this feature, refer to the order drawing for all exact lighting placements. These installation instructions are for most cases and for reference. Not all installs will have strobes, beacons, and lightbars. Reference the instructions for only what you are installing.

Harness pictures are for reference only.

## Placements

Switch placement: Dash panel right of park brake.



Front Strobes: Grill



**\*\*\*TORQUE STROBES TO 10-IN-LB'S MAXIMUM\*\*\***

Rear Strobes: Rear Bumper



# Routing Overview

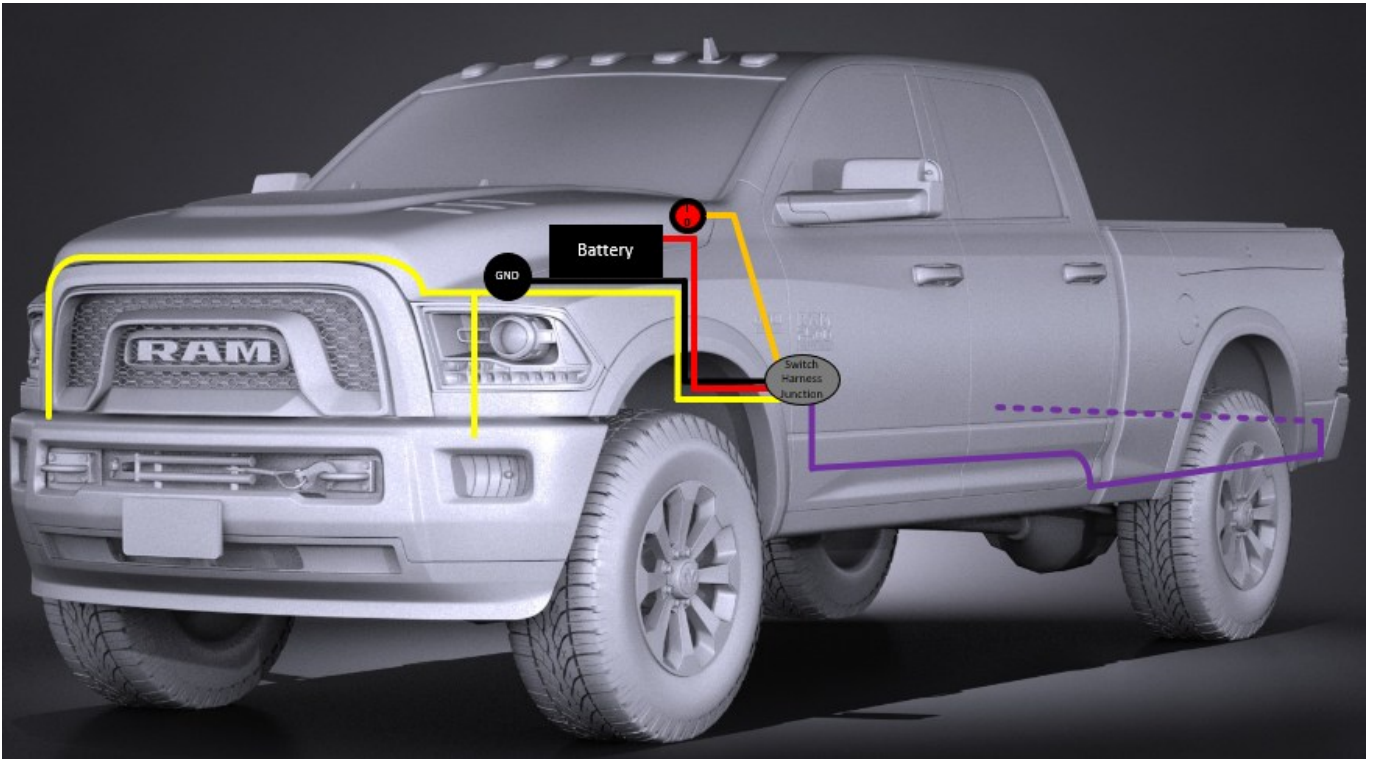

Color	Key - Items
Yellow	Strobes - Front strobe harness #2
Red/Black	Power harness: Battery to kick panel
Orange	Switch harness: Switch in dash
Blue	Beacon harness: Switch to beacon
Purple	Strobes - Rear strobe harness #2



Figure 8.1

**Step 1:** Locate the power harness #67095.

Remove the fuse from the inline fuse holder until the end of the install

Locate the OEM battery under the hood.

**Step 2:**

Attach the red wire with the ring terminal to the battery positive post.

Attach the black wire with the ring terminal to the OEM ground stud just forward of the battery.

Figure 8.1.

**Step 3:**

Locate the firewall grommet from underneath the kick panel inside the cab on the driver's side.

Figure 8.2.

Drill a hole (to fit the grommet on the power harness) to the bottom-right of the OEM grommet, like shown.

**\*\*BE SURE TO CHECK THAT THE OPPOSING SIDE OF THE FIREWALL IS CLEAR BEFORE DRILLING.\*\***

Route the white connector end through the firewall and insert the grommet on the sheet metal. Make sure to leave a drip loop with the harness.

**Reference Pg. 3 for routing through the firewall.**

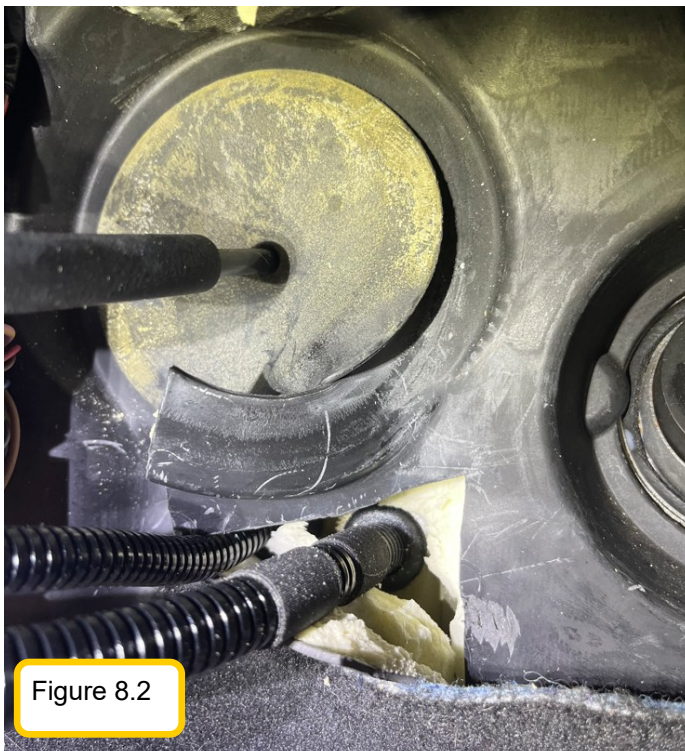

Figure 8.2

Power harness

Switch Harness



**Step 4:**

Locate the switch harness #67097

Connect the switch harness connector to the power harness in the kick panel area.

Remove the knee bolster trim.

Route the switch end of the switch harness up the dash and through the opening.

Secure to the OEM harnesses behind the IP.



↑  
Front

Figure 9.1

**Step 5:**

Drill a hole for the switch, in the trim panel like shown below.

The hole will be 2" inches up from the bottom of the trim panel and 1.5" from the right edge.

Route the harnesses through the hole.

**Step 6:**

Connect the ground spade to the gold pin on the rocker switch

Connect the white battery power spade to the opposite terminal on the switch.

Connect the red spade to the middle pin

Insert the switch into the hole and place the strobe/beacon decal (if supplied) around the switch.

Reassemble all trim and secure wiring.



## Strobe Install—If Applicable

Strobe pictures are for reference only. Please refer to product structure/spec sheets for the actual strobes for the install.

Figure 11.1



### Step 1:

Locate the rear strobe harness #67107.

Connect the rear strobe harness to the switch harness (one of the remaining unused connectors) in the driver's foot well.

### Step 2:

Locate the driver's side door sill area.

Use a trim tool to remove the trim panels in the driver's step well and dash/kick panel.

Continue routing to the rear door sill trim.





**Step 3: Routing (Refer to routing diagrams at the beginning of the instructions)**

Lift the rear carpet and locate the OEM grommet.

From below the vehicle, use a knife to cut an 'X' into the grommet.

Route the harness under the carpet and through the grommet.

Follow the frame to the rear of the vehicle.





#### Step 4: Mounting Rear Strobes

From the trim split, measure 1.5" inward and 2" down. Mark and drill the hole for the cable passthrough.

Repeat for the passenger side.

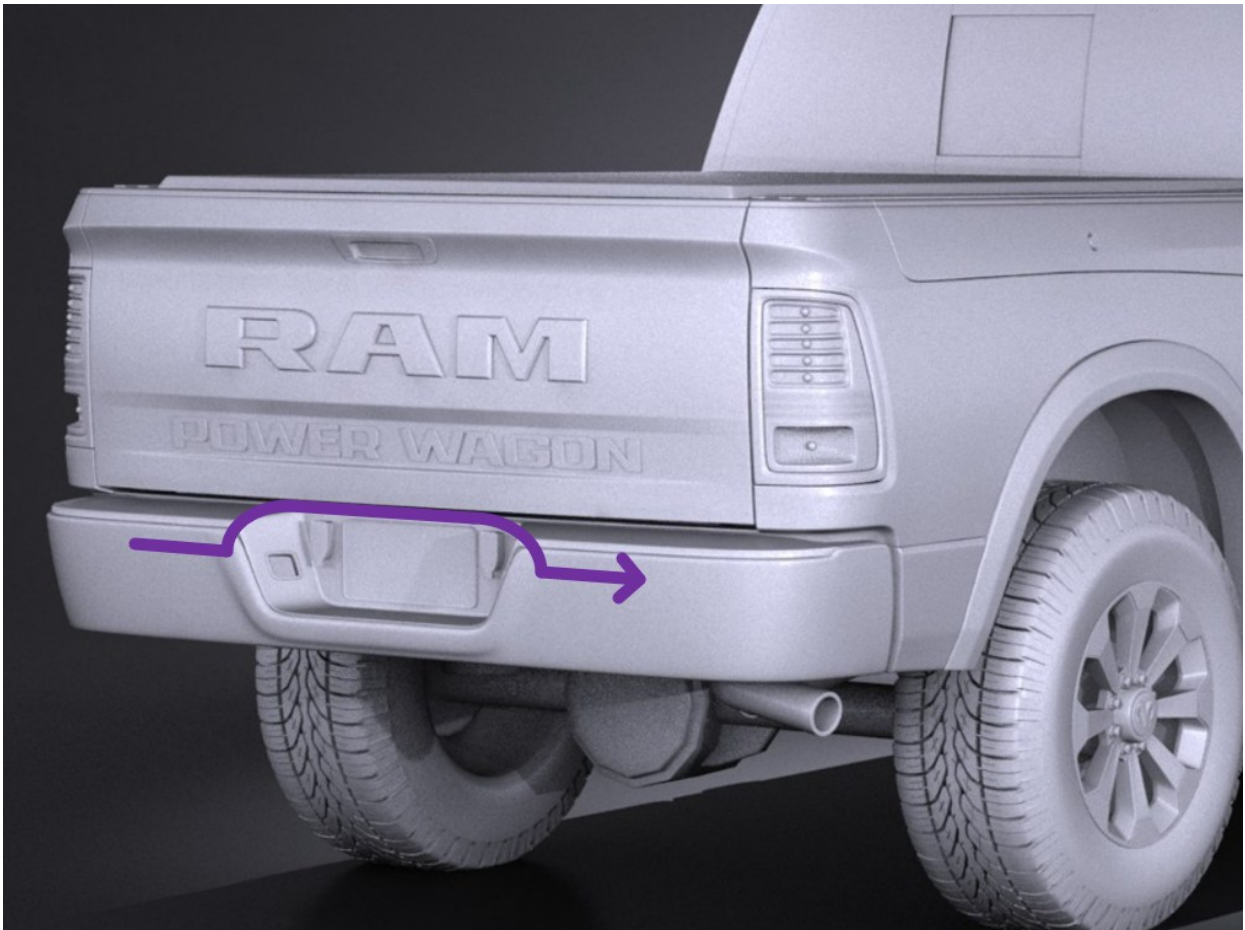

**Step 5: Routing (Refer to routing diagrams at the beginning of the instructions)**

Using the front strobe harness, connect to the switch harness and pass through the firewall.

Remove the plastic cover from the front. Route the harness along the outside edge towards the front of the vehicle. Drop the shorter leg down and continue to the passenger side. Route the harness below the cover.



### Step 6: Mounting Front Strobes

Locate the split in the headlight, this will be the horizontal indicator of where to place the strobes.

The bottom edge of the strobe will be flush with the bottom of the plastic panel.

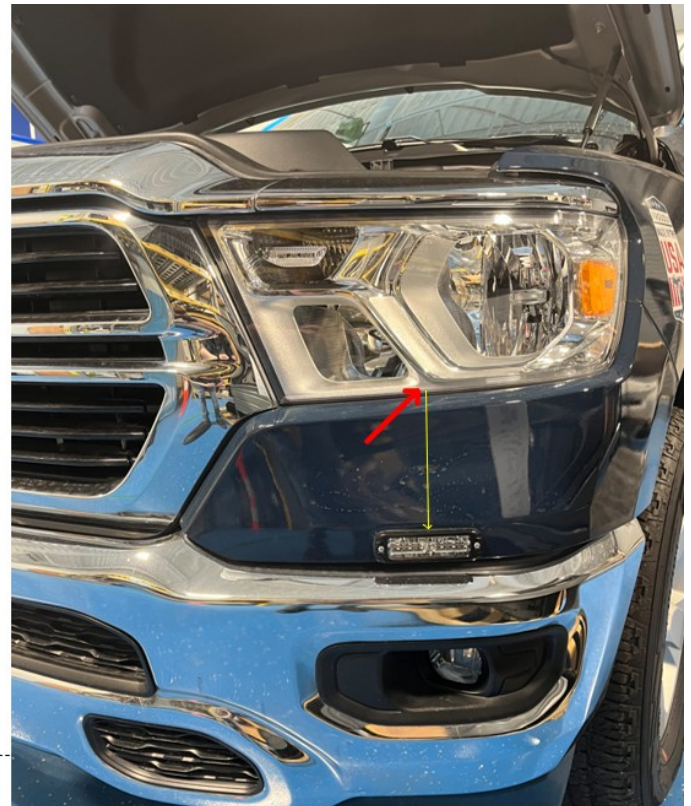



**Insert the fuse into the inline-fuse holder on the power harness. The install is now complete. Secure all wiring with zip ties. Re-attach all trim. Re-assure all pass through holes have been silicone. Double check the functionality of the lights and switches.**

PART NUMBER

13905-0

**ITEM DESCRIPTION: WIRE TIE, NYLON 40Lb, 8.5" BLACK**



MANUFACTURER: WAYTEK, INC. or equivalent  
MANUFACTURERS PART NUMBER: 21093M or 21093C

SPECIFICATIONS:     STANDARD CABLE TIE  
                          BLACK, NYLON  
                          8-1/2" LONG  
                          TENSILE STRENGTH: 40.0 LBS  
                          21093M = 1,000 quantity  
                          21093C = 100 quantity

SPECIAL NOTES: PART NUMBER IS BLACK.

**SUPPLIED BY: THIS ITEM IS ADRIAN AVAILABLE!**

**PURCHASED PRODUCT DATA SHEET (PPDS)**

THIS DRAWING/INFORMATION IS THE PROPERTY OF ADRIAN STEEL COMPANY AND IS NOT TO BE USED IN ANY MANNER THAT IS DETRIMENTAL TO THE INTEREST OF ADRIAN STEEL. COPYRIGHTS AND OR PATENTS THAT MAY BE THE PROPERTY OF APPLICABLE OWNERS MAY PROTECT INFORMATION AND/OR DRAWINGS OF SUPPLIED PRODUCTS.



**ADRIAN STEEL**  
VAN AND PICKUP EQUIPMENT

906 JAMES STREET  
ADRIAN, MI 49221  
517-265-6194  
WWW.ADRIANSTEEL.COM



**WHEN INSTALLING EQUIPMENT IN OR ON VEHICLES CHECK FOR FUEL TANKS, FUEL LINES, CONTROL LINES AND ELECTRICAL WIRING BEFORE DRILLING! ALWAYS USE DRILL BITS WITH INTEGRAL STOPS WHENEVER POSSIBLE!**

DRAWN BY MDG	DATE DRAWN 10/26/2006
ECN NUMBER 18021	ECN DATE 11/13/2015
PART WEIGHT 0.01 LBS.	REV. LEVEL D
PART NUMBER <b>13905-0</b>	

PART NUMBER

26618-0

ITEM DESCRIPTION: SILICONE, 1oz. TUBE



SPECIFICATIONS: SU5005 RTV SILICONE  
1oz. TUBE  
CLEAR OR EQUIVALENT  
SELF PIERCING CAP

SPECIAL NOTES:

**SUPPLIED BY: THIS ITEM IS ADRIAN AVAILABLE!**

**PURCHASED PRODUCT DATA SHEET (PPDS)**

THIS DRAWING/INFORMATION IS THE PROPERTY OF ADRIAN STEEL COMPANY AND IS NOT TO BE USED IN ANY MANNER THAT IS DETRIMENTAL TO THE INTEREST OF ADRIAN STEEL. COPYRIGHTS AND OR PATENTS THAT MAY BE THE PROPERTY OF APPLICABLE OWNERS MAY PROTECT INFORMATION AND/OR DRAWINGS OF SUPPLIED PRODUCTS.



**ADRIAN STEEL**  
VAN AND PICKUP EQUIPMENT

906 JAMES STREET  
ADRIAN, MI 49221  
517-265-6194

WWW.ADRIANSTEEL.COM

**CAUTION**

WHEN INSTALLING EQUIPMENT IN OR ON VEHICLES CHECK FOR FUEL TANKS, FUEL LINES, CONTROL LINES AND ELECTRICAL WIRING BEFORE DRILLING! ALWAYS USE DRILL BITS WITH INTEGRAL STOPS WHENEVER POSSIBLE!

DRAWN BY  
JLC

DATE DRAWN  
7/21/2001

ECN NUMBER  
16551

ECN DATE  
7/22/2014

PART WEIGHT  
0.02 LBS.

REV. LEVEL  
C

PART NUMBER  
**26618-0**

PART NUMBER

26618-0

ITEM DESCRIPTION: SILICONE, 1oz. TUBE



SPECIFICATIONS: SU5005 RTV SILICONE  
1oz. TUBE  
CLEAR OR EQUIVALENT  
SELF PIERCING CAP

SPECIAL NOTES:

**SUPPLIED BY: THIS ITEM IS ADRIAN AVAILABLE!**

**PURCHASED PRODUCT DATA SHEET (PPDS)**

THIS DRAWING/INFORMATION IS THE PROPERTY OF ADRIAN STEEL COMPANY AND IS NOT TO BE USED IN ANY MANNER THAT IS DETRIMENTAL TO THE INTEREST OF ADRIAN STEEL. COPYRIGHTS AND OR PATENTS THAT MAY BE THE PROPERTY OF APPLICABLE OWNERS MAY PROTECT INFORMATION AND/OR DRAWINGS OF SUPPLIED PRODUCTS.



**ADRIAN STEEL**  
VAN AND PICKUP EQUIPMENT

906 JAMES STREET  
ADRIAN, MI 49221  
517-265-6194

WWW.ADRIANSTEEL.COM

**CAUTION**

WHEN INSTALLING EQUIPMENT IN OR ON VEHICLES CHECK FOR FUEL TANKS, FUEL LINES, CONTROL LINES AND ELECTRICAL WIRING BEFORE DRILLING! ALWAYS USE DRILL BITS WITH INTEGRAL STOPS WHENEVER POSSIBLE!

DRAWN BY  
JLC

DATE DRAWN  
7/21/2001

ECN NUMBER  
16551

ECN DATE  
7/22/2014

PART WEIGHT  
0.02 LBS.

REV. LEVEL  
C

PART NUMBER  
**26618-0**

**ITEM DESCRIPTION: STROBE SWITCH DECAL SET**

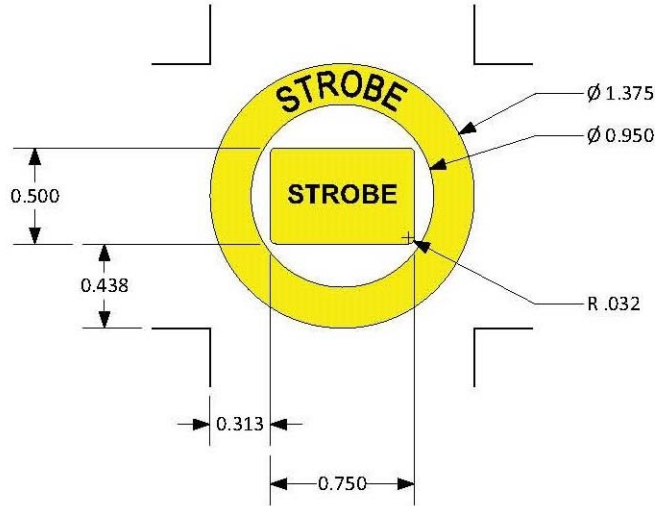

MANUFACTURER: VANNER  
MANUFACTURERS PART NUMBER: TBD

SPECIFICATIONS: (1) Circular Yellow Decal (ID=0.950", OD=1.375") with "STROBE" in black letters  
(1) Rectangular Yellow Decal (H=0.500", L=0.750") with "STROBE" in black letters

SPECIAL NOTES: For round rocker switch (OD=0.780") and Ford Transit Upfitter Switches.

**SUPPLIED BY: THIS ITEM IS ADRIAN AVAILABLE!**

**PURCHASED PRODUCT DATA SHEET (PPDS)**

THIS DRAWING/INFORMATION IS THE PROPERTY OF ADRIAN STEEL COMPANY AND IS NOT TO BE USED IN ANY MANNER THAT IS DETRIMENTAL TO THE INTEREST OF ADRIAN STEEL. COPYRIGHTS AND OR PATENTS THAT MAY BE THE PROPERTY OF APPLICABLE OWNERS MAY PROTECT INFORMATION AND/OR DRAWINGS OF SUPPLIED PRODUCTS.



**906 JAMES STREET  
ADRIAN, MI 49221  
517-265-6194  
WWW.ADRIANSTEEL.COM**



**CAUTION**  
WHEN INSTALLING EQUIPMENT IN OR ON VEHICLES CHECK FOR FUEL TANKS, FUEL LINES, CONTROL LINES AND ELECTRICAL WIRING BEFORE DRILLING! ALWAYS USE DRILL BITS WITH INTEGRAL STOPS WHENEVER POSSIBLE!

DRAWN BY RJB	DATE DRAWN 11/15/2017
ECN NUMBER XXXX	ECN DATE XXXXXX
PART WEIGHT 0.02 LBS.	REV. LEVEL A
PART NUMBER <b>55073</b>	

REVISIONS		
REV	DESCRIPTION	DATE

- NOTES:
1. MATERIAL : .002 YELLOW POLYESTER
  2. ARTWORK FROM D91XXXX-A PAGE 1, PMS BLACK
  3. .001 OVERLAMINATE
  4. ADHESIVE BACKED

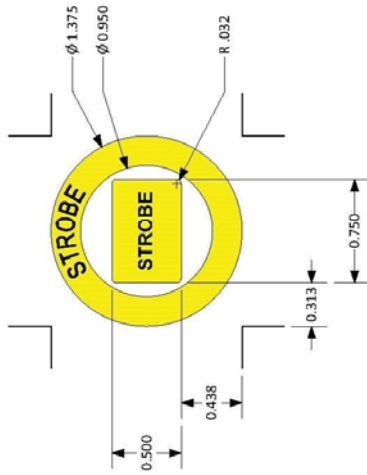

		HILLIARD, OHIO USA	
TOL. LABEL/METAL	.x ± .025 .xx ± .015 .xxx ± .005	REAEACO NO.:	XXXX
TITLE:	LABEL, STROBE TXT, .95ID ROUND SWITCH	THIS DRAWING AND ALL INFORMATION CONTAINED HEREIN IS THE PROPERTY OF VANNER INC. AND MAY NOT BE COPIED, REPRODUCED OR DIVULGED TO UNAUTHORIZED PERSONS WITHOUT THE EXPRESS WRITTEN CONSENT OF VANNER INC. IT IS PROVIDED SOLELY FOR THE CONVENIENCE OF THE USER AND SHALL BE RETURNED UPON REQUEST.	
DRAWING/ PART NO.	D01XXXX	SCALE:	NONE
REV SHEET 1 OF 1	A	DRNDATE	11/14/17
CHKDATE	XXX	TOL. CABLES	.xxx ± .25
		DRNDATE	11/14/17

PART NUMBER  
**55073**

THIS DRAWING/INFORMATION IS THE PROPERTY OF ADRIAN STEEL COMPANY AND IS NOT TO BE USED IN ANY MANNER THAT IS DETRIMENTAL TO THE INTEREST OF ADRIAN STEEL. COPYRIGHTS AND OR PATENTS THAT MAY BE THE PROPERTY OF APPLICABLE OWNERS MAY PROTECT INFORMATION AND/OR DRAWINGS OF SUPPLIED PRODUCTS.

**ADRIAN STEEL**  
Cargo Management Solutions for Commercial Vehicles

906 JAMES STREET  
ADRIAN, MI 49221  
517-265-6194  
WWW.ADRIANSTEEL.COM

**CAUTION**

WHEN INSTALLING EQUIPMENT IN OR ON VEHICLES CHECK FOR FUEL TANKS, FUEL LINES, CONTROL LINES AND ELECTRICAL WIRING BEFORE DRILLING! ALWAYS USE DRILL BITS WITH INTEGRAL STOPS WHENEVER POSSIBLE!

DRAWN BY RJB	DATE DRAWN 11/15/2017
ECN NUMBER XXXX	ECN DATE XXXXXXX
PART WEIGHT 0.02 LBS.	REV. LEVEL A
PART NUMBER <b>55073</b>	

LOC | QTY | Part # | Description | Size

Material: IJ39 | Lamination: 8518

1: 6039597.Strobe Switch-1.52" x 2.07"



**Note: Part will not be weeded, just cut.**

Kit# 8001872 | Adrian Steel Part # 55073

06/01/2023 • JY  
© 2022 DISTYLL Graphics Solutions. All rights reserved.

ASCO REV.1 6/14/2023

<p><b>DISTYLL</b> GRAPHIC SOLUTIONS</p> <p>FINAL DESIGN</p>	CLIENT NAME:		Switch Decals		O-ID: O15319-1
	Adrian Steel				
	DATE:	DESIGNER:			
	O5/31/2023	TRN			

Please check information to confirm accurate vehicle specifications.

**CLEANING INSTRUCTIONS** All surfaces must be considered contaminated. Clean the vehicle surface immediately before applying the film. Dust and other contaminants can collect quickly on the surface and prevent the film from adhering properly. Even a freshly painted surface can collect dust before graphics can be applied.

For the best success with the films recommended for vehicle graphics, always apply the graphics when the air and vehicle surface are both above 60°F (16°C) and below 90°F (32°C) before beginning the installation.

# PURCHASED COMPONENT KEY FEATURES

## DESCRIPTION OF REQUIREMENTS

DIMENSIONAL REQUIREMENTS (AS SHOWN ON DRAWING)

N/A

LOAD/RATING REQUIREMENT

N/A

MATERIAL REQUIREMENT

N/A

PACKAGING REQUIREMENT

N/A

OTHER REQUIREMENTS

**Note:**  
This is also from HellermannTyton:  
Their Part Number is 156-00592



THIS DRAWING IS THE PROPERTY OF ADRIAN STEEL COMPANY AND IS NOT TO BE USED IN ANY MANNER DETRIMENTAL TO THE INTERESTS OF ADRIAN STEEL COMPANY

## TOLERANCES & INSPECTION

*UNLESS OTHERWISE SPECIFIED*

ALL BEND ANGLES ARE 90 DEGREES

ALL DIMENSIONS ARE IN INCHES.

REFERENCE DIMENSIONS (X.XXX)  
DO NOT REQUIRE INSPECTION

FEATURES	HOLES/SLOTS	ANGLES
0.0 = ± .125	0.0 = ± .062	0° = ± 2°
0.00 = ± .062	0.00 = ± .031	0.0° = ± 1°
0.000 = ± .031	0.000 = ± .015	

Material Thickness: per ASTM Std.  
Weld Callouts per AWS

## RELEASE & REVISIONS

INITIAL ECN: **22671**

CURRENT ECN: **22671**

ECN DESCRIPTION:

**RELEASE TO PRODUCTION**

REVISED BY: **EMS**

# PURCHASED COMPONENT

REFERENCED SUPPLIER AND/OR MANUFACTURER

**Fastenal**

REFERENCED SUPPLIER AND/OR MANUFACTURER PART NUMBER

**0787863**

COLOR (ONLY LIST IF COLOR SPECIFIC)

COMODITY ITEM (Y/N) (YES = ALL DIMENSIONS AND NOTES ARE REFERENCE)  
(NOTE: DIMENSIONS AND FEATURES MAY VARY FOR A COMODITY ITEM.)

**NO**

PRINTED DOCUMENT IS UNCONTROLLED

Sheet 1 of 1

## PART / PRODUCT IDENTIFICATION



**ADRIAN STEEL®**

ADRIAN STEEL COMPANY  
906 JAMES STREET, ADRIAN, MI 49221

REVISION LEVEL

**A**

MAT'L USED:

DESIGNED BY: **EMS**

DESCRIPTION:

**Clip, Black UV Tie, HellermannTyton**

WEIGHT (Lbs.): **0.5**

SEGMENT CODE: **ELE**

PART NUMBER: **59713**

# PURCHASED COMPONENT KEY FEATURES

## DESCRIPTION OF REQUIREMENTS

DIMENSIONAL REQUIREMENTS (AS SHOWN ON DRAWING)

N/A

LOAD/RATING REQUIREMENT

N/A

MATERIAL REQUIREMENT

N/A

PACKAGING REQUIREMENT

N/A

OTHER REQUIREMENTS



THIS DRAWING IS THE PROPERTY OF ADRIAN STEEL COMPANY AND IS NOT TO BE USED IN ANY MANNER DETRIMENTAL TO THE INTERESTS OF ADRIAN STEEL COMPANY

PRINTED DOCUMENT IS UNCONTROLLED

Sheet 1 of 1

## TOLERANCES & INSPECTION

UNLESS OTHERWISE SPECIFIED

ALL BEND ANGLES ARE 90 DEGREES

ALL DIMENSIONS ARE IN INCHES.

REFERENCE DIMENSIONS (X.XXX)  
DO NOT REQUIRE INSPECTION

FEATURES	HOLES/SLOTS	ANGLES
0.0 = ± .125	0.0 = ± .062	0° = ± 2°
0.00 = ± .062	0.00 = ± .031	0.0° = ± 1°
0.000 = ± .031	0.000 = ± .015	

Material Thickness: per ASTM Std.  
Weld Callouts per AWS

## RELEASE & REVISIONS

INITIAL ECN: **25378**

CURRENT ECN: **25378**

ECN DESCRIPTION:

**RELEASE FOR PRODUCTION**

REVISED BY:

# PURCHASED COMPONENT

REFERENCED SUPPLIER AND/OR MANUFACTURER

**AAMP GLOBAL**

REFERENCED SUPPLIER AND/OR MANUFACTURER PART NUMBER

**67095 OR PWR-HAR4**

COLOR (ONLY LIST IF COLOR SPECIFIC)

COMODITY ITEM (Y/N) (YES = ALL DIMENSIONS AND NOTES ARE REFERENCE)  
(NOTE: DIMENSIONS AND FEATURES MAY VARY FOR A COMODITY ITEM.)

**NO**

## PART / PRODUCT IDENTIFICATION



**ADRIAN STEEL®**

ADRIAN STEEL COMPANY  
906 JAMES STREET, ADRIAN, MI 49221

REVISION LEVEL

**A**

MAT'L USED: **PURCHASED**

DESIGNED BY: **E.BURKE**

DESCRIPTION: **POWER HARNESS EXTERIOR 4**

WEIGHT (Lbs.): **0.2**

SEGMENT CODE: **ELE**

PART NUMBER: **67095**

Coverings	
Id	Assembly
[7]	
[8]	

Notes	
①	Lock Tape Loom with Tesa 51036
②	Add 15A Mini Fuse
③	Add rubber grommet over harness loom; 150mm behind C2

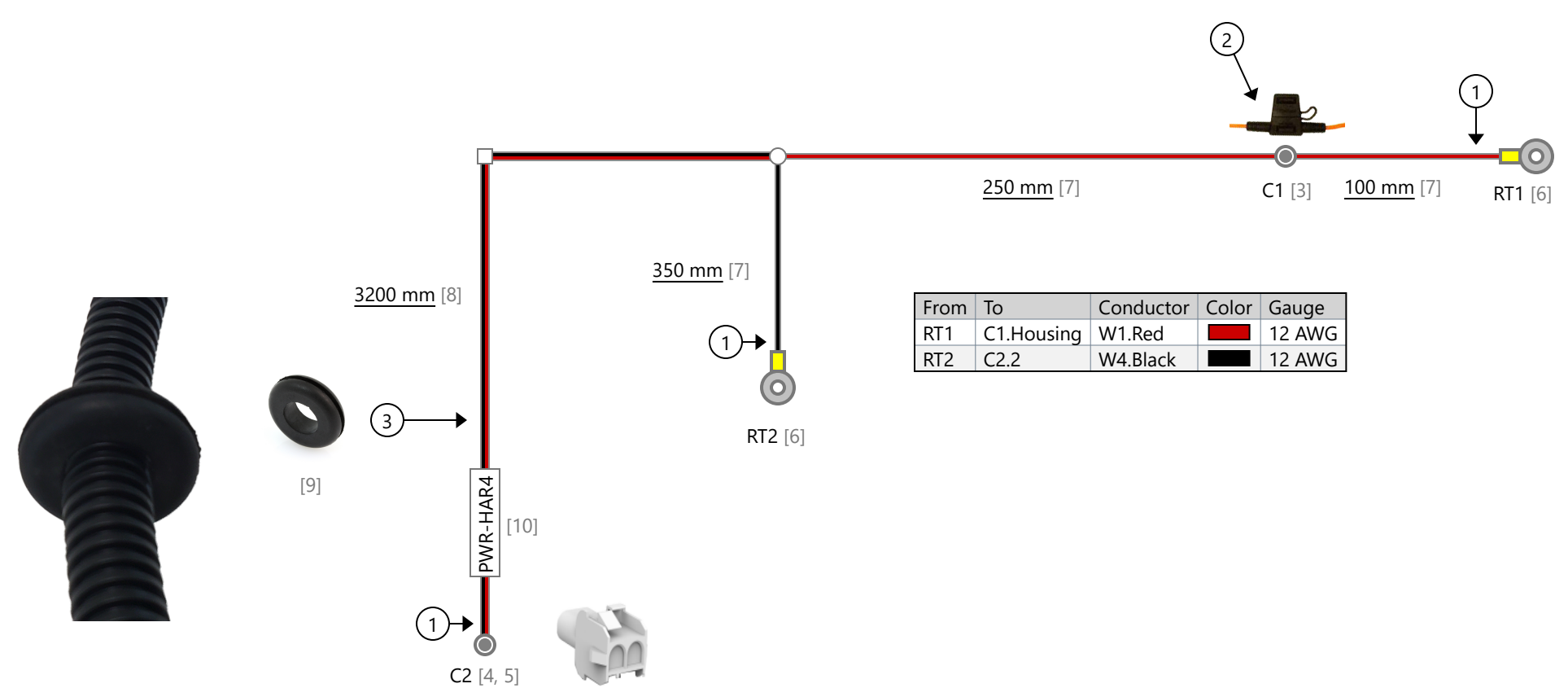

From	To	Conductor	Color	Gauge
RT1	C1.Housing	W1.Red		12 AWG
RT2	C2.2	W4.Black		12 AWG

From	To	Color	Gauge
C2.1	C1.Housing		12 AWG
C2.2	RT2		12 AWG

Revisions			
Rev.	Date	Author	Description
A	11/5/2021	Bennet Fisher	Initial Drawing

UNLESS OTHERWISE SPECIFIED DIMENSIONS ARE IN MILLIMETERS [INCHES] TOLERANCES: ±5MM  <b>PROPRIETARY AND CONFIDENTIAL</b>  THE INFORMATION CONTAINED IN THIS DRAWING IS THE SOLE PROPERTY OF AAMP GLOBAL. ANY REPRODUCTION IN PART OR AS A WHOLE WITHOUT THE WRITTEN PERMISSION OF AAMP GLOBAL IS PROHIBITED.	Designed By	Bennet Fisher	11/5/2021	  Part Number: PWR-HAR4 Description: Exterior Light Battery Harness Revision: ---- Sheet: 1 of 1
	Engineering Approval	----	----	
	Manufacturing Approval	----	----	
	Revision Approval	----	----	
	Quality Assurance	----	----	

# PURCHASED COMPONENT KEY FEATURES

## DESCRIPTION OF REQUIREMENTS

DIMENSIONAL REQUIREMENTS (AS SHOWN ON DRAWING)

N/A

LOAD/RATING REQUIREMENT

N/A

MATERIAL REQUIREMENT

N/A

PACKAGING REQUIREMENT

N/A

OTHER REQUIREMENTS



THIS DRAWING IS THE PROPERTY OF ADRIAN STEEL COMPANY AND IS NOT TO BE USED IN ANY MANNER DETRIMENTAL TO THE INTERESTS OF ADRIAN STEEL COMPANY

## TOLERANCES & INSPECTION

UNLESS OTHERWISE SPECIFIED

ALL BEND ANGLES ARE 90 DEGREES

ALL DIMENSIONS ARE IN INCHES.

REFERENCE DIMENSIONS (X.XXX)  
DO NOT REQUIRE INSPECTION

FEATURES	HOLES/SLOTS	ANGLES
0.0 = ± .125	0.0 = ± .062	0° = ± 2°
0.00 = ± .062	0.00 = ± .031	0.0° = ± 1°
0.000 = ± .031	0.000 = ± .015	

Material Thickness: per ASTM Std.  
Weld Callouts per AWS

## RELEASE & REVISIONS

INITIAL ECN: **25378**

CURRENT ECN: **25378**

ECN DESCRIPTION:

**RELEASE FOR PRODUCTION**

REVISED BY:

# PURCHASED COMPONENT

REFERENCED SUPPLIER AND/OR MANUFACTURER

**AAMP GLOBAL**

REFERENCED SUPPLIER AND/OR MANUFACTURER PART NUMBER

**SSW-HAR1 OR 67097**

COLOR (ONLY LIST IF COLOR SPECIFIC)

COMODITY ITEM (Y/N) (YES = ALL DIMENSIONS AND NOTES ARE REFERENCE)  
(NOTE: DIMENSIONS AND FEATURES MAY VARY FOR A COMODITY ITEM.)

**NO**

PRINTED DOCUMENT IS UNCONTROLLED

Sheet 1 of 1

## PART / PRODUCT IDENTIFICATION



**ADRIAN STEEL®**

ADRIAN STEEL COMPANY  
906 JAMES STREET, ADRIAN, MI 49221

REVISION LEVEL

**A**

MAT'L USED: **PURCHASED**

DESIGNED BY: **E.BURKE**

DESCRIPTION: **SWITCH HARNESS 1 EXTERIOR LIGHTING**

WEIGHT (Lbs.): **0.2**

SEGMENT CODE: **ELE**

PART NUMBER: **67097**

Coverings	
Id	Assembly
[12]	

Notes	
①	Lock Tape Loom with Tesa 51608
②	75mm between end of loom and Quick Connects

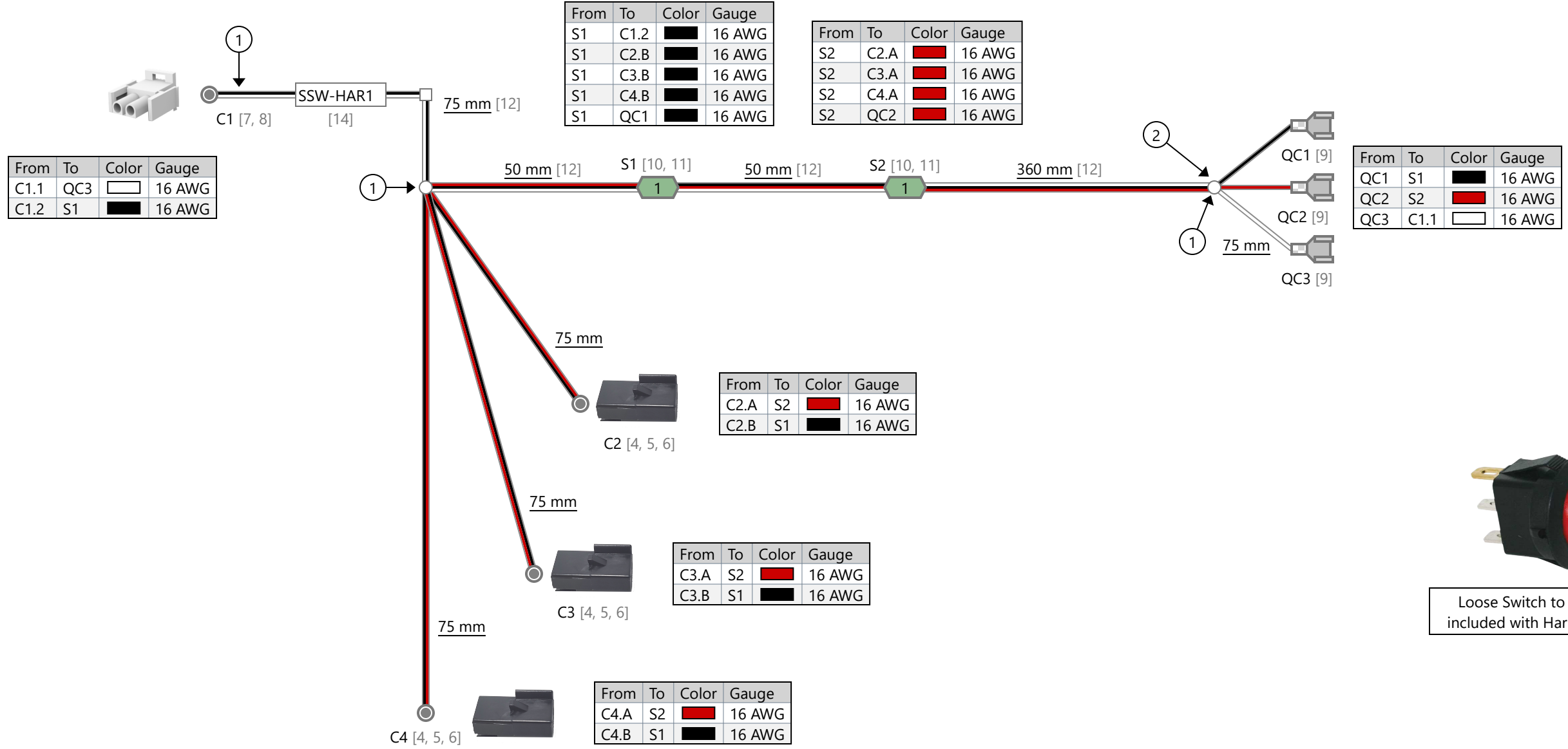

Revisions			
Rev.	Date	Author	Description
A	11/5/2021	Bennet Fisher	Initial Drawing

UNLESS OTHERWISE SPECIFIED DIMENSIONS ARE IN MILLIMETERS (INCHES) TOLERANCES: ±5MM		Name	Date
DESIGNED BY		Bennet Fisher	11/5/2021
ENGINEERING APPROVAL		----	----
MANUFACTURING APPROVAL		----	----
REVISION APPROVAL		----	----
QUALITY ASSURANCE		----	----



— ADVANCING VEHICLE TECHNOLOGY —

Part Number: SSW-HAR1	Revision: ----
Description: Strobe Switch Harness - 3 Outputs	Sheet: 1 of 1

**PROPRIETARY AND CONFIDENTIAL**

THE INFORMATION CONTAINED IN THIS DRAWING IS THE SOLE PROPERTY OF AAMP GLOBAL. ANY REPRODUCTION IN PART OR AS A WHOLE WITHOUT THE WRITTEN PERMISSION OF AAMP GLOBAL IS PROHIBITED.

# PURCHASED COMPONENT KEY FEATURES

## DESCRIPTION OF REQUIREMENTS

DIMENSIONAL REQUIREMENTS (AS SHOWN ON DRAWING)

N/A

LOAD/RATING REQUIREMENT

N/A

MATERIAL REQUIREMENT

N/A

PACKAGING REQUIREMENT

N/A

OTHER REQUIREMENTS



THIS DRAWING IS THE PROPERTY OF ADRIAN STEEL COMPANY AND IS NOT TO BE USED IN ANY MANNER DETRIMENTAL TO THE INTERESTS OF ADRIAN STEEL COMPANY

## TOLERANCES & INSPECTION

UNLESS OTHERWISE SPECIFIED

ALL BEND ANGLES ARE 90 DEGREES

ALL DIMENSIONS ARE IN INCHES.

REFERENCE DIMENSIONS (X.XXX)  
DO NOT REQUIRE INSPECTION

FEATURES	HOLES/SLOTS	ANGLES
0.0 = ± .125	0.0 = ± .062	0° = ± 2°
0.00 = ± .062	0.00 = ± .031	0.0° = ± 1°
0.000 = ± .031	0.000 = ± .015	

Material Thickness: per ASTM Std.  
Weld Callouts per AWS

## RELEASE & REVISIONS

INITIAL ECN: **25378**

CURRENT ECN: **25378**

ECN DESCRIPTION:

**RELEASE FOR PRODUCTION**

REVISED BY:

# PURCHASED COMPONENT

REFERENCED SUPPLIER AND/OR MANUFACTURER

**AAMP GLOBAL**

REFERENCED SUPPLIER AND/OR MANUFACTURER PART NUMBER

**FS-HAR2 OR 67102**

COLOR (ONLY LIST IF COLOR SPECIFIC)

COMODITY ITEM (Y/N) (YES = ALL DIMENSIONS AND NOTES ARE REFERENCE)  
(NOTE: DIMENSIONS AND FEATURES MAY VARY FOR A COMODITY ITEM.)

**NO**

PRINTED DOCUMENT IS UNCONTROLLED

Sheet 1 of 1

## PART / PRODUCT IDENTIFICATION



**ADRIAN STEEL®**

ADRIAN STEEL COMPANY  
906 JAMES STREET, ADRIAN, MI 49221

REVISION LEVEL

**A**

MAT'L USED: **PURCHASED**

DESIGNED BY: **E.BURKE**

DESCRIPTION: **FRONT STROBE HARNESS 2**

WEIGHT (Lbs.): **0.2**

SEGMENT CODE: **ELE**

PART NUMBER: **67102**

Coverings	
Id	Assembly
[12]	

Notes	
①	Lock Tape Loom with Tesa 51036

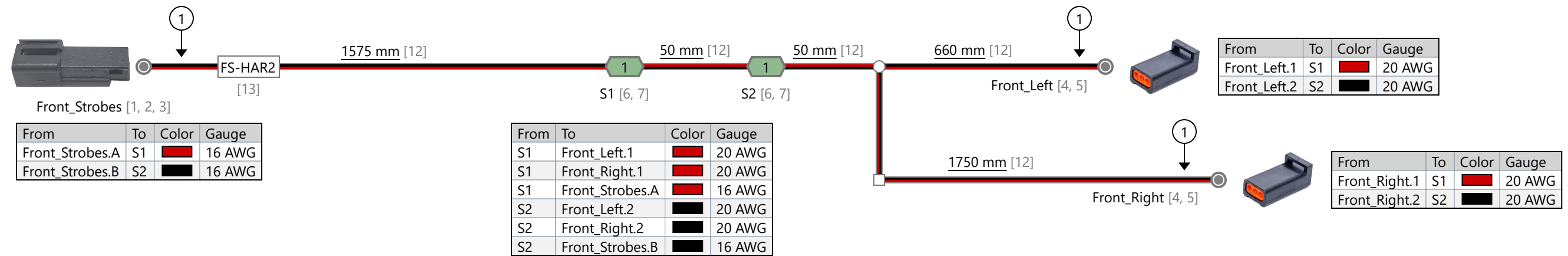

Revisions			
Rev.	Date	Author	Description
A	11/5/2021	Bennet Fisher	Initial Drawing

UNLESS OTHERWISE SPECIFIED DIMENSIONS ARE IN MILLIMETERS (INCHES) TOLERANCES: ±5MM  <b>PROPRIETARY AND CONFIDENTIAL</b>  THE INFORMATION CONTAINED IN THIS DRAWING IS THE SOLE PROPERTY OF AAMP GLOBAL. ANY REPRODUCTION IN PART OR AS A WHOLE WITHOUT THE WRITTEN PERMISSION OF AAMP GLOBAL IS PROHIBITED.	Designed By	Bennet Fisher	11/5/2021	 — ADVANCING VEHICLE TECHNOLOGY —  Part Number: FS-HAR2 Description: Front Strobe Harness Revision: ---- Sheet: 1 of 1
	Engineering Approval	----	----	
	Manufacturing Approval	----	----	
	Revision Approval	----	----	
	Quality Assurance	----	----	

# PURCHASED COMPONENT KEY FEATURES

## DESCRIPTION OF REQUIREMENTS

DIMENSIONAL REQUIREMENTS (AS SHOWN ON DRAWING)

N/A

LOAD/RATING REQUIREMENT

N/A

MATERIAL REQUIREMENT

N/A

PACKAGING REQUIREMENT

N/A

OTHER REQUIREMENTS



THIS DRAWING IS THE PROPERTY OF ADRIAN STEEL COMPANY AND IS NOT TO BE USED IN ANY MANNER DETRIMENTAL TO THE INTERESTS OF ADRIAN STEEL COMPANY

## TOLERANCES & INSPECTION

UNLESS OTHERWISE SPECIFIED

ALL BEND ANGLES ARE 90 DEGREES

ALL DIMENSIONS ARE IN INCHES.

REFERENCE DIMENSIONS (X.XXX)  
DO NOT REQUIRE INSPECTION

FEATURES	HOLES/SLOTS	ANGLES
0.0 = ± .125	0.0 = ± .062	0° = ± 2°
0.00 = ± .062	0.00 = ± .031	0.0° = ± 1°
0.000 = ± .031	0.000 = ± .015	

Material Thickness: per ASTM Std.  
Weld Callouts per AWS

## RELEASE & REVISIONS

INITIAL ECN: **25378**

CURRENT ECN: **25378**

ECN DESCRIPTION:

**RELEASE FOR PRODUCTION**

REVISED BY:

# PURCHASED COMPONENT

REFERENCED SUPPLIER AND/OR MANUFACTURER

**AAMP GLOBAL**

REFERENCED SUPPLIER AND/OR MANUFACTURER PART NUMBER

**RS-HAR2 OR 67107**

COLOR (ONLY LIST IF COLOR SPECIFIC)

COMODITY ITEM (Y/N) (YES = ALL DIMENSIONS AND NOTES ARE REFERENCE)  
(NOTE: DIMENSIONS AND FEATURES MAY VARY FOR A COMODITY ITEM.)

**NO**

PRINTED DOCUMENT IS UNCONTROLLED

Sheet 1 of 1

## PART / PRODUCT IDENTIFICATION



**ADRIAN STEEL®**

ADRIAN STEEL COMPANY  
906 JAMES STREET, ADRIAN, MI 49221

REVISION LEVEL

**A**

MAT'L USED: **PURCHASED**

DESIGNED BY: **E.BURKE**

DESCRIPTION: **REAR STROBE HARNESS 2**

WEIGHT (Lbs.): **0.2**

SEGMENT CODE: **ELE**

PART NUMBER: **67107**

Coverings	
Id	Assembly
[12]	

Notes	
①	Lock Tape Loom with Tesa 51036

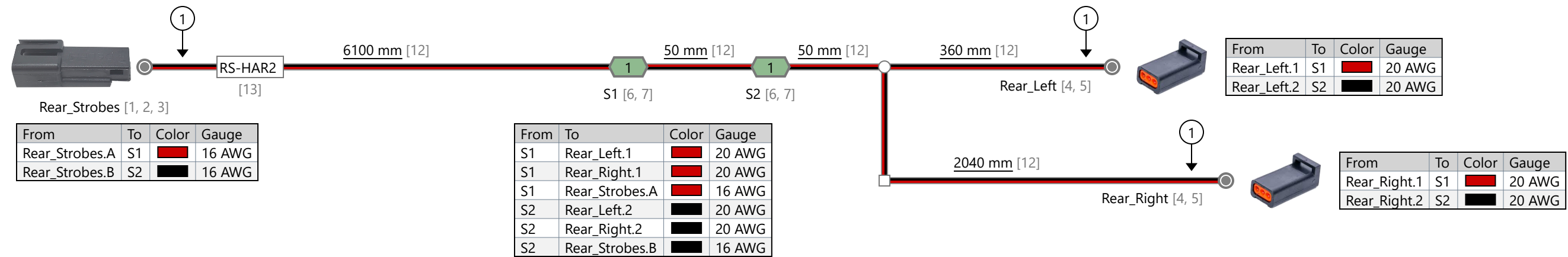

From	To	Color	Gauge
Rear_Strokes.A	S1	Red	16 AWG
Rear_Strokes.B	S2	Black	16 AWG

From	To	Color	Gauge
S1	Rear_Left.1	Red	20 AWG
S1	Rear_Right.1	Red	20 AWG
S1	Rear_Strokes.A	Red	16 AWG
S2	Rear_Left.2	Black	20 AWG
S2	Rear_Right.2	Black	20 AWG
S2	Rear_Strokes.B	Black	16 AWG

From	To	Color	Gauge
Rear_Left.1	S1	Red	20 AWG
Rear_Left.2	S2	Black	20 AWG

From	To	Color	Gauge
Rear_Right.1	S1	Red	20 AWG
Rear_Right.2	S2	Black	20 AWG

Revisions			
Rev.	Date	Author	Description
A	11/5/2021	Bennet Fisher	Initial Drawing

UNLESS OTHERWISE SPECIFIED DIMENSIONS ARE IN MILLIMETERS (INCHES) TOLERANCES: ±5MM		Name	Date
DESIGNED BY		Bennet Fisher	11/5/2021
ENGINEERING APPROVAL		----	----
MANUFACTURING APPROVAL		----	----
REVISION APPROVAL		----	----
QUALITY ASSURANCE		----	----



— ADVANCING VEHICLE TECHNOLOGY —

Part Number: RS-HAR2	Revision: ----
Description: Rear Strobe Harness	Sheet: 1 of 1

**PROPRIETARY AND CONFIDENTIAL**

THE INFORMATION CONTAINED IN THIS DRAWING IS THE SOLE PROPERTY OF AAMP GLOBAL. ANY REPRODUCTION IN PART OR AS A WHOLE WITHOUT THE WRITTEN PERMISSION OF AAMP GLOBAL IS PROHIBITED.

# PURCHASED COMPONENT KEY FEATURES

## DESCRIPTION OF REQUIREMENTS

DIMENSIONAL REQUIREMENTS (AS SHOWN ON DRAWING)

N/A

LOAD/RATING REQUIREMENT

N/A

MATERIAL REQUIREMENT

N/A

PACKAGING REQUIREMENT

N/A

OTHER REQUIREMENTS



THIS DRAWING IS THE PROPERTY OF ADRIAN STEEL COMPANY AND IS NOT TO BE USED IN ANY MANNER DETRIMENTAL TO THE INTERESTS OF ADRIAN STEEL COMPANY

## TOLERANCES & INSPECTION

UNLESS OTHERWISE SPECIFIED

ALL BEND ANGLES ARE 90 DEGREES

ALL DIMENSIONS ARE IN INCHES.

REFERENCE DIMENSIONS (X.XXX)  
DO NOT REQUIRE INSPECTION

FEATURES	HOLES/SLOTS	ANGLES
0.0 = ± .125	0.0 = ± .062	0° = ± 2°
0.00 = ± .062	0.00 = ± .031	0.0° = ± 1°
0.000 = ± .031	0.000 = ± .015	

Material Thickness: per ASTM Std.  
Weld Callouts per AWS

## RELEASE & REVISIONS

INITIAL ECN: **25378**

CURRENT ECN: **25378**

ECN DESCRIPTION:

**RELEASE FOR PRODUCTION**

REVISED BY:

# PURCHASED COMPONENT

REFERENCED SUPPLIER AND/OR MANUFACTURER

**AAMP GLOBAL**

REFERENCED SUPPLIER AND/OR MANUFACTURER PART NUMBER

**BLB-HAR3 OR 67113**

COLOR (ONLY LIST IF COLOR SPECIFIC)

COMODITY ITEM (Y/N) (YES = ALL DIMENSIONS AND NOTES ARE REFERENCE)  
(NOTE: DIMENSIONS AND FEATURES MAY VARY FOR A COMODITY ITEM.)

**NO**

PRINTED DOCUMENT IS UNCONTROLLED

Sheet 1 of 1

## PART / PRODUCT IDENTIFICATION



**ADRIAN STEEL®**

ADRIAN STEEL COMPANY  
906 JAMES STREET, ADRIAN, MI 49221

REVISION LEVEL

**A**

MAT'L USED: **PURCHASED**

DESIGNED BY: **E.BURKE**

DESCRIPTION: **BEACON/LIGHTBAR HARNESS 3**

WEIGHT (Lbs.): **0.2**

SEGMENT CODE: **EBE**

PART NUMBER: **67113**

Bill of Materials

Id	Type	Manufacturer	Part Number	Quantity
1	Cable		16AWG 2C FT2 TPU Cable	6300 mm
2	Cord Grip		PG11	1

Notes

- ① Heat shrink cable jacket and wire 20mm behind connector (Heat shrink = 38mm long)
- ② Place adhesive lined heat shrink over C2 connector wire cavities and cable jacket (Heat shrink = 38mm long)
- ③ Install Cable Gland/Cord Grip 300mm behind C2
- ④ Plug C3 into C2
- ⑤ C3 Cavities are sealed



From	To	Color	Gauge
C1.A	C2.1	Red	16 AWG
C1.B	C2.2	Black	16 AWG

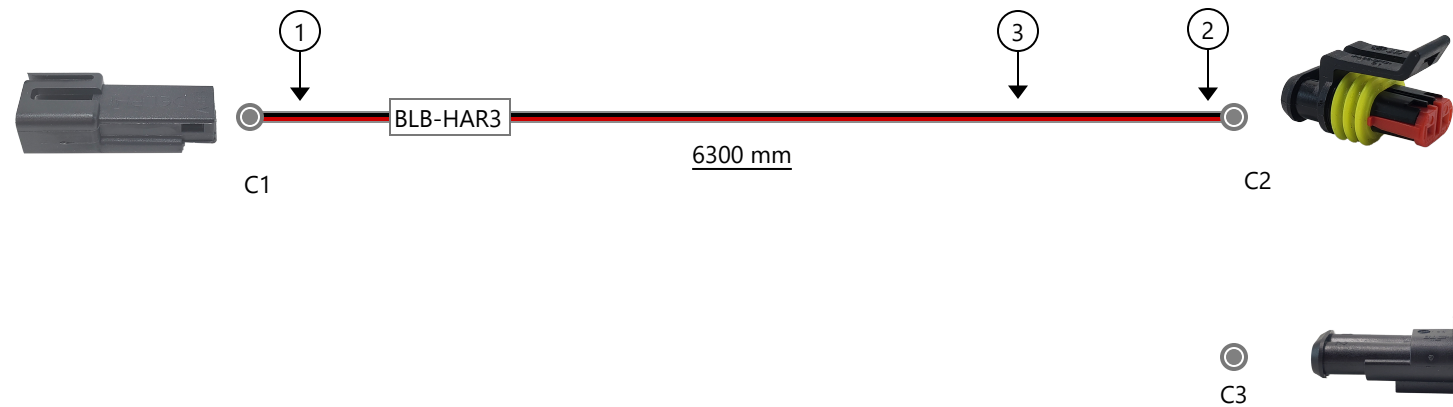

From	To	Color	Gauge
C2.1	C1.A	Red	16 AWG
C2.2	C1.B	Black	16 AWG

Revisions			
Rev.	Date	Author	Description
	11/5/2021	Bennet Fisher	Initial Drawing
	3/21/2022	Bennet Fisher	Added 300mm to harness; changed female connector
A	4/26/2022	Bennet Fisher	Added adhesive lined heat shrink to C2

UNLESS OTHERWISE SPECIFIED DIMENSIONS ARE IN MILLIMETERS [INCHES] TOLERANCES: ±5MM  <b>PROPRIETARY AND CONFIDENTIAL</b>  THE INFORMATION CONTAINED IN THIS DRAWING IS THE SOLE PROPERTY OF AAMP GLOBAL. ANY REPRODUCTION IN PART OR AS A WHOLE WITHOUT THE WRITTEN PERMISSION OF AAMP GLOBAL IS PROHIBITED.		Name	Date	
	Designed By	Bennet Fisher	04/26/2022	
	Engineering Approval			
	Manufacturing Approval			
	Revision Approval			
Quality Assurance				
			Part Number: BLB-HAR3_	Revision: A
			Description: Beacon/Light Bar Harness - 6.3 Meters	Sheet: 1

# PURCHASED COMPONENT KEY FEATURES

## DESCRIPTION OF REQUIREMENTS

DIMENSIONAL REQUIREMENTS (AS SHOWN ON DRAWING)

N/A

LOAD/RATING REQUIREMENT

N/A

MATERIAL REQUIREMENT

N/A

PACKAGING REQUIREMENT

N/A

OTHER REQUIREMENTS

**ECCO STROBE LIGHT: ED3801  
WITH EXTERIOR PLUG AND PLAY CONNECTOR**



THIS DRAWING IS THE PROPERTY OF ADRIAN STEEL COMPANY AND IS NOT TO BE USED IN ANY MANNER DETRIMENTAL TO THE INTERESTS OF ADRIAN STEEL COMPANY

## TOLERANCES & INSPECTION

*UNLESS OTHERWISE SPECIFIED*

ALL BEND ANGLES ARE 90 DEGREES

ALL DIMENSIONS ARE IN INCHES.

REFERENCE DIMENSIONS (X.XXX)  
DO NOT REQUIRE INSPECTION

FEATURES	HOLES/SLOTS	ANGLES
0.0 = ± .125	0.0 = ± .062	0° = ± 2°
0.00 = ± .062	0.00 = ± .031	0.0° = ± 1°
0.000 = ± .031	0.000 = ± .015	

Material Thickness: per ASTM Std.  
Weld Callouts per AWS

## RELEASE & REVISIONS

INITIAL ECN: **25921**

CURRENT ECN: **25921**

ECN DESCRIPTION:

**RELEASE TO PRODUCTION**

REVISED BY: **N/A**

# PURCHASED COMPONENT

REFERENCED SUPPLIER AND/OR MANUFACTURER

**ECCO**

REFERENCED SUPPLIER AND/OR MANUFACTURER PART NUMBER

**ED3801A-ADR**

COLOR (ONLY LIST IF COLOR SPECIFIC)

**AMBER LED/CLEAR LENS**

COMODITY ITEM (Y/N) (YES = ALL DIMENSIONS AND NOTES ARE REFERENCE)  
(NOTE: DIMENSIONS AND FEATURES MAY VARY FOR A COMODITY ITEM.)

**NO**

PRINTED DOCUMENT IS UNCONTROLLED

Sheet 1 of 1

## PART / PRODUCT IDENTIFICATION



**ADRIAN STEEL®**

ADRIAN STEEL COMPANY  
906 JAMES STREET, ADRIAN, MI 49221

REVISION LEVEL

**A**

MAT'L USED: **PURCHASED**

DESIGNED BY: **EMB**

DESCRIPTION: **ECCO STROBE ED3801A W/CON**

WEIGHT (Lbs.): **0.5**

SEGMENT CODE: **EST**

PART NUMBER: **67686**

# PURCHASED COMPONENT KEY FEATURES

## DESCRIPTION OF REQUIREMENTS

DIMENSIONAL REQUIREMENTS (AS SHOWN ON DRAWING)

N/A

LOAD/RATING REQUIREMENT

N/A

MATERIAL REQUIREMENT

N/A

PACKAGING REQUIREMENT

N/A

OTHER REQUIREMENTS

**WHELEN LIGHTBAR: R2LPPCA WITH EXTERIOR PLUG AND PLAY CONNECTOR CLEAR LENS AMBER LED'S**

**CUSTOM R2LPPCA WITH W446, WPF. 2 SOCK CONNECTR KIT AMP WITH LOOM / GROMET / PATTERN WIRE TAPE / SETTING OF THE PATTERN**

**WHELEN PART NUMBER: R2LPPCA-AS CUSTOM / 01-0689088C1P0**



THIS DRAWING IS THE PROPERTY OF ADRIAN STEEL COMPANY AND IS NOT TO BE USED IN ANY MANNER DETRIMENTAL TO THE INTERESTS OF ADRIAN STEEL COMPANY

## TOLERANCES & INSPECTION

*UNLESS OTHERWISE SPECIFIED*

ALL BEND ANGLES ARE 90 DEGREES

ALL DIMENSIONS ARE IN INCHES.

REFERENCE DIMENSIONS (X.XXX)  
DO NOT REQUIRE INSPECTION

FEATURES	HOLES/SLOTS	ANGLES
0.0 = ± .125	0.0 = ± .062	0° = ± 2°
0.00 = ± .062	0.00 = ± .031	0.0° = ± 1°
0.000 = ± .031	0.000 = ± .015	

Material Thickness: per ASTM Std.  
Weld Callouts per AWS

## RELEASE & REVISIONS

INITIAL ECN: **25921**

CURRENT ECN: **28678**

ECN DESCRIPTION:

**Add Updated Part Number to PPDS**

REVISED BY: **LJK**

# PURCHASED COMPONENT

REFERENCED SUPPLIER AND/OR MANUFACTURER

**WHELEN**

REFERENCED SUPPLIER AND/OR MANUFACTURER PART NUMBER

**R2LPPCA-AS CUSTOM / 01-0689088C1P0**

COLOR (ONLY LIST IF COLOR SPECIFIC)

**CLEAR LENS / AMBER LED'S**

COMODITY ITEM (Y/N) (YES = ALL DIMENSIONS AND NOTES ARE REFERENCE)  
(NOTE: DIMENSIONS AND FEATURES MAY VARY FOR A COMODITY ITEM.)

**NO**

PRINTED DOCUMENT IS UNCONTROLLED

Sheet 1 of 1

## PART / PRODUCT IDENTIFICATION



**ADRIAN STEEL®**

ADRIAN STEEL COMPANY  
906 JAMES STREET, ADRIAN, MI 49221

REVISION LEVEL

**B**

MAT'L USED: **PURCHASED**

DESIGNED BY: **EMB**

DESCRIPTION: **WHELEN LP LGHTBR AM W/CON**

WEIGHT (Lbs.): **1.5**

SEGMENT CODE: **EBE**

PART NUMBER: **67692**