

Introduction / Comments:

Install Instructions For Exterior Plug & Play Lights For Promaster City

Note:

Read all instructions prior to installation. Review the Adrian Steel **GENERAL PRECAUTIONS PAGES (56638)** before attempting installation. Only personnel familiar with using electrical best practices should perform this install. Reference **ELECTRICAL BEST PRACTICES MANUAL (54479)** before attempting installation.

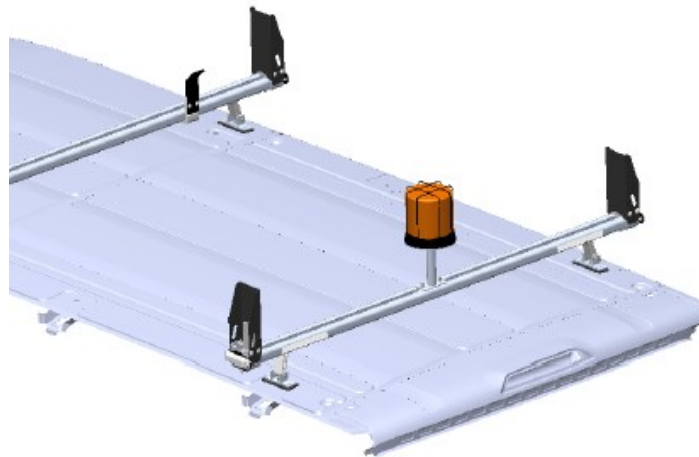

Installation Instructions For Exterior Plug And Play Lights For Promaster City

Table of Contents:

Torque requirements.....2

Best Practice for Routing Through the Firewall.....3

Introduction Statement.....4

Overall Harness Diagram.....4

Tools needed.....4

Harnesses/Components Needed (If Applicable).....5

Component Placements.....6

Overall Harness Routing.....7

Beginning Install.....8

Strobe Installation Instructions.....10

Beacon Installation Instructions.....14

*****TORQUE*****
Torque all strobe fasteners to 10 in-lbs.
DO NOT OVER TIGHTEN

DO NOT MOUNT ON A CURVED SURFACE

Best Practices to Follow when Routing Through Firewall:

- Create a drip loop with the harness being routed through the firewall as shown so that the water does not flow into the grommet.
- Make sure that the proper grommet for the hole being routed through is used so that there are no openings for water to get through.
- Use silicone after routing and apply around the grommet and wire to seal it. Make sure to let the silicone dry for 30 minutes to an hour.

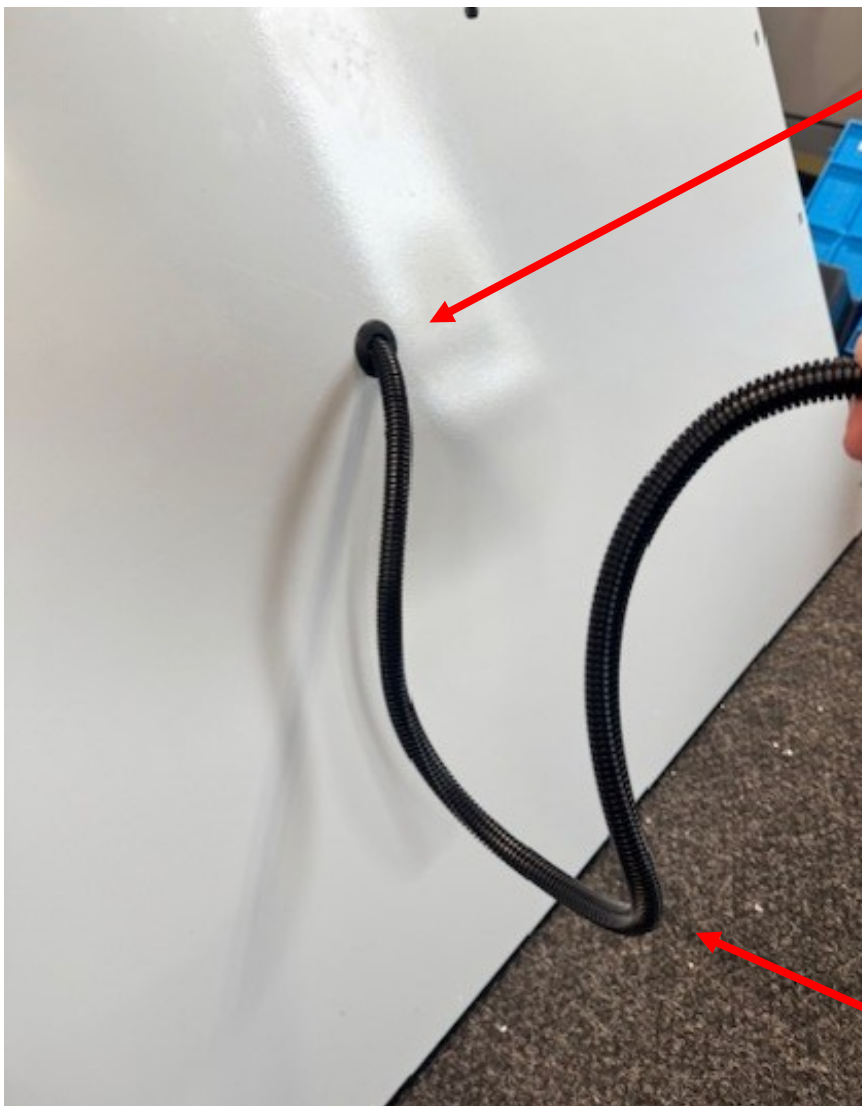

Apply silicone around the grommet and wire loom so that it is completely sealed.

Drip loop created so water runs off of loom and not into the cab of the vehicle.

****Please read statement below before moving forward****

Before installation, disconnect the OEM negative battery cable.

These plug and play kits are completely modular and can be configured in many different ways. Placement of lights will be determined by sales order drawings/customer ask. Therefore, these instructions are for the most standard configurations, and for reference only.

Please reference the order drawing and spec sheet to see what components are going to be installed on this particular upfit.

These installation instructions are for most cases and for reference. Not all installs will have strobes, beacons, and lightbars. Reference the instructions for only what you are installing.

Overall Harness Diagram

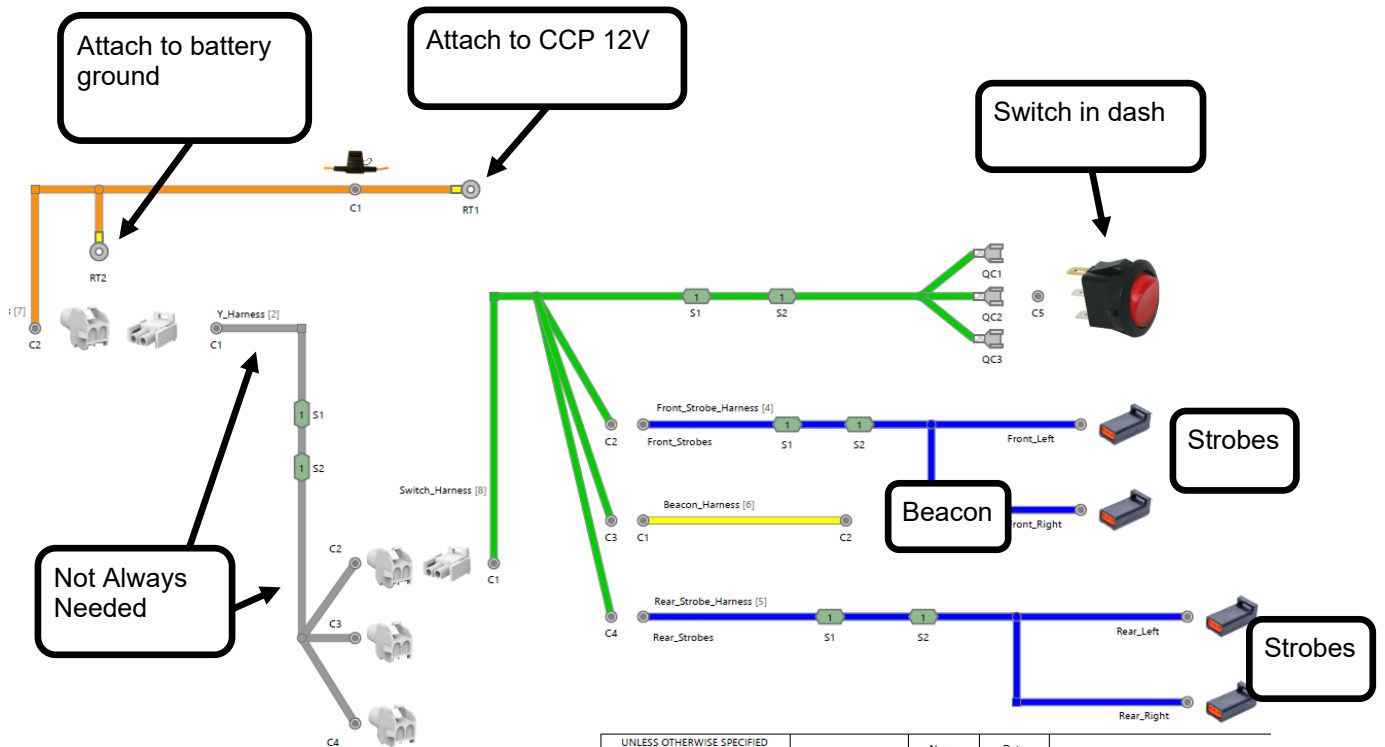

Tools required:

13mm deep well socket

Phillips bit, 1/2" drill bit and 5/16" step drill bit

Power drill and impact

Torque wrench

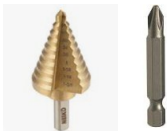

Components

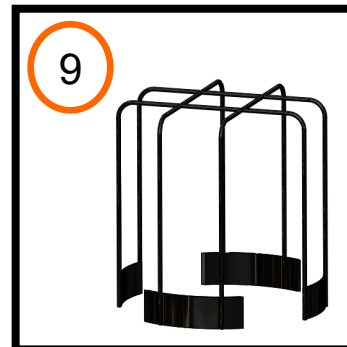
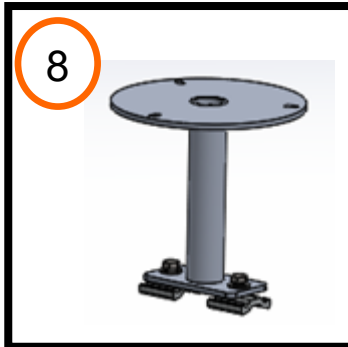
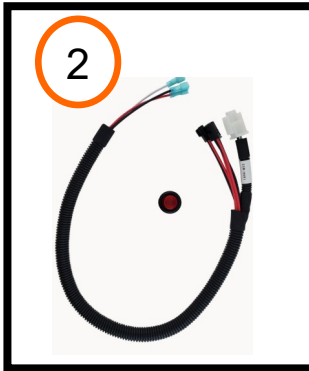
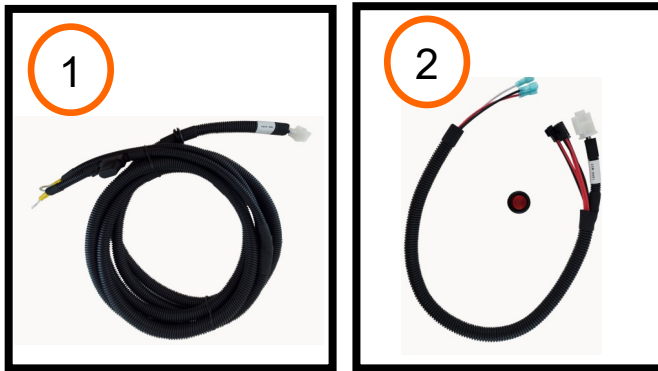

	Part Number	Description
1	67092	Power Harness #1
2	67097	Switch Harness #1
3	67102	Front Strobe Harness #2 (If Applicable)
4	67107	Rear Strobe Harness #2 (If Applicable)
5	67112 or 67113	Beacon/Lightbar Harness #2 or #3 (If Applicable)
6	67686 or 67687	Strobes (If Applicable)
7	67689 or 67690	Beacons (If Applicable)
8	51545	Beacon Ladder rack Mount (If Applicable)
9	50368	Beacon Cage

The purpose of plug and play lighting is to be completely modular. Due to this feature, refer to the order drawing for all exact lighting placements. These installation instructions are for most cases and for reference. Not all installs will have strobes, beacons, and lightbars. Reference the instructions for only what you are installing.

Harness pictures are for reference only.

Placements

Switch placement: On Dash Trim Panel



Front Strobes: Front Bumper



*****TORQUE STROBES TO 10-IN-LB'S MAXIMUM*****

Beacon or Lightbar: On Ladder Rack

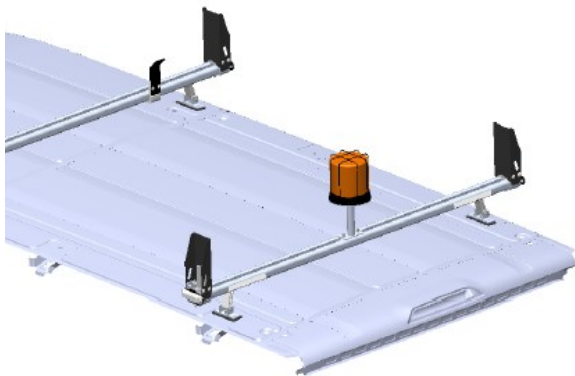

Rear Strobes: Above Rear Tail-lights



Routing Overview

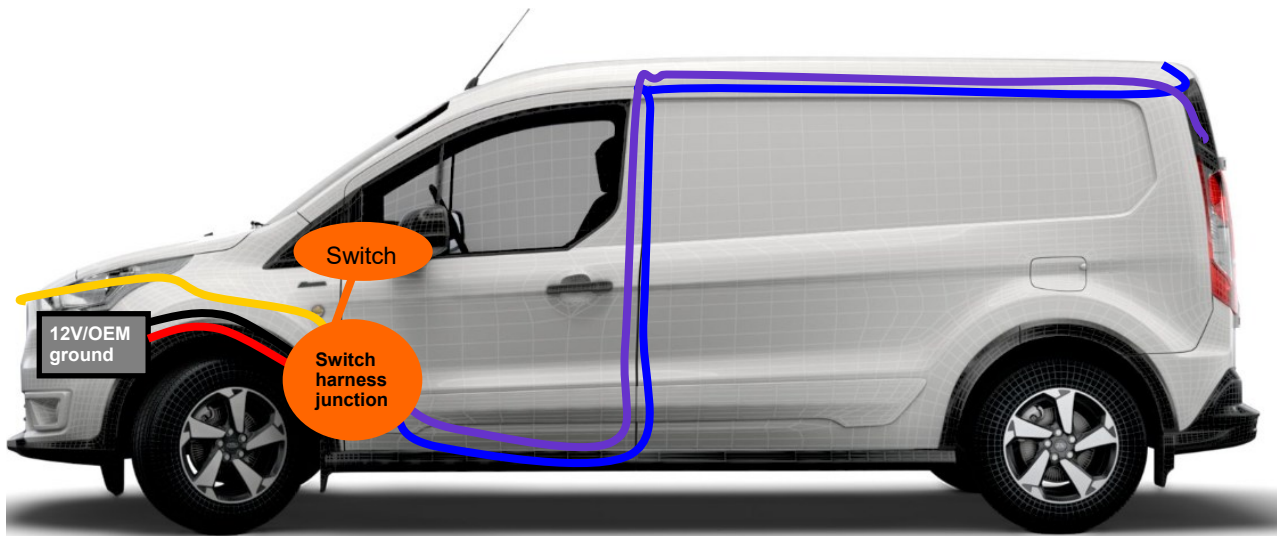
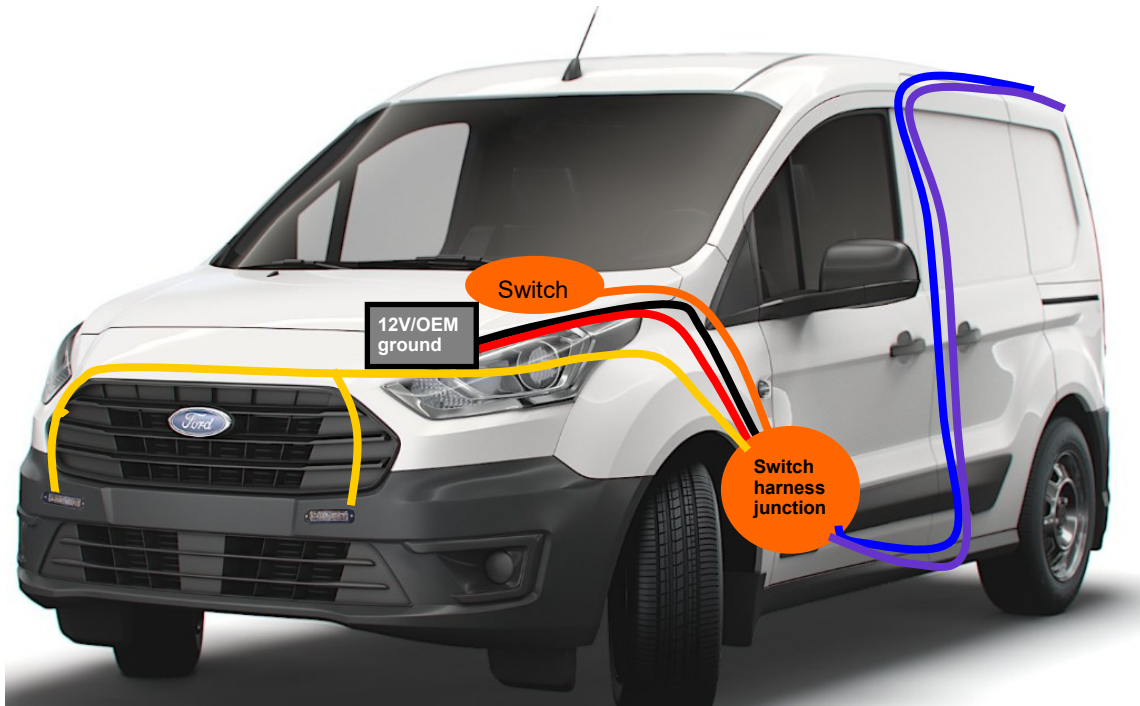

Color	Key - Items
Yellow	Strobes - Front strobe harness
Red/Black	Power harness: Battery to kick panel
Orange	Switch harness: Switch in dash
Blue	Beacon harness: Switch to beacon
Purple	Strobes - Rear strobe harness



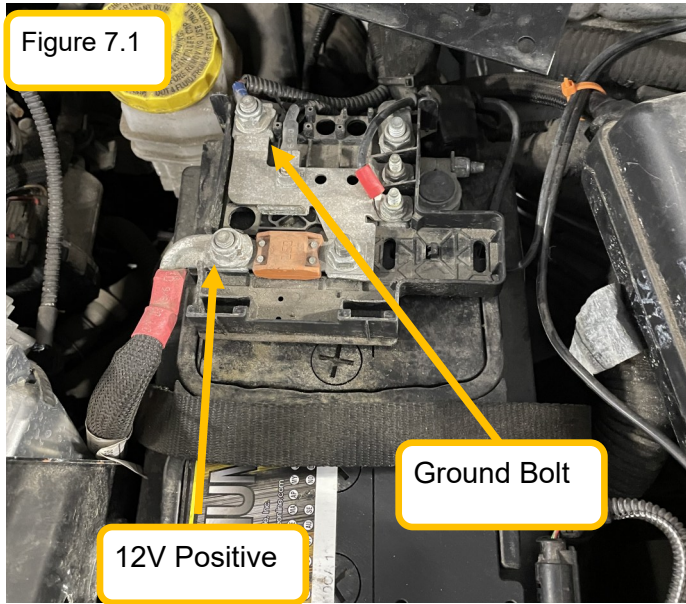

Step 1: Locate the power harness #67092.

Remove the fuse from the inline fuse holder until the end of the install

Under the hood: Locate the OEM battery. Remove the cover to expose the terminals Figure 7.1.

Step 2:

Attach the red wire with the ring terminal to the 12V positive post.

Attach the black wire with the ring terminal to the OEM ground post.

Route the white connector end towards the cab and locate the OEM grommet (to the cab). It's best seen looking from the cab area under the steering wheel. Figure 7.2 and 7.3. Secure with zip ties. Routing shown in red.

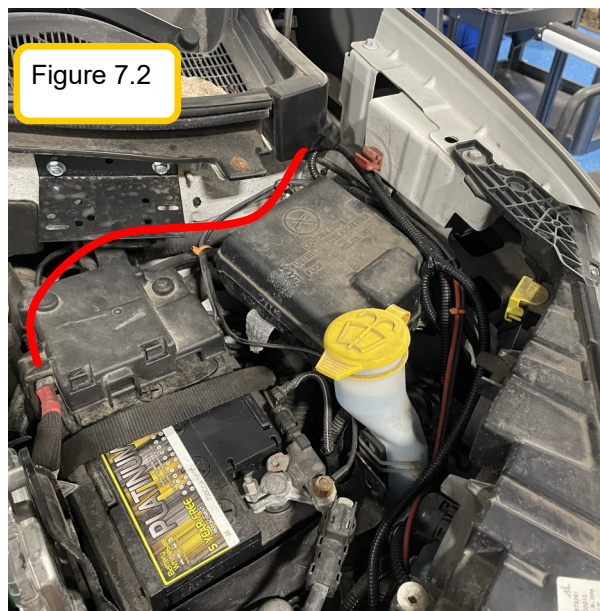

Step 3:

Cut/drill a hole in the grommet to route the power harness through. Make sure to make a drip loop with the harness.

****If you are installing strobes on this install route the strobe harness interior connector in through the grommet at this time as well. Refer to page 9 for routing strobe instructions.** Figure 7.4 for connector reference.

Silicone the grommet holes/wiring once all harnesses have been routed through.

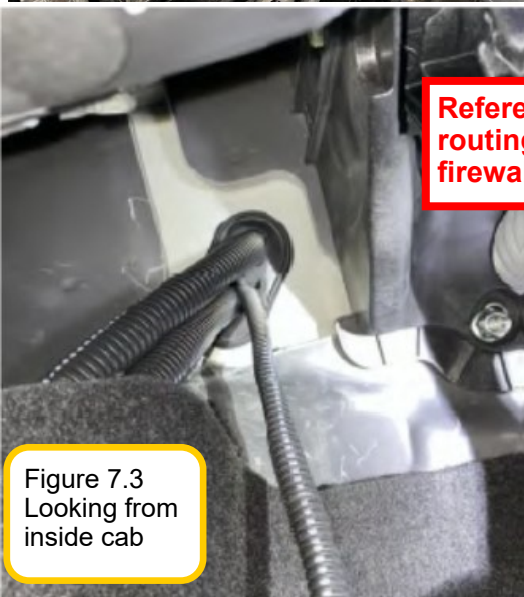

Reference Pg. 3 for routing through the firewall.

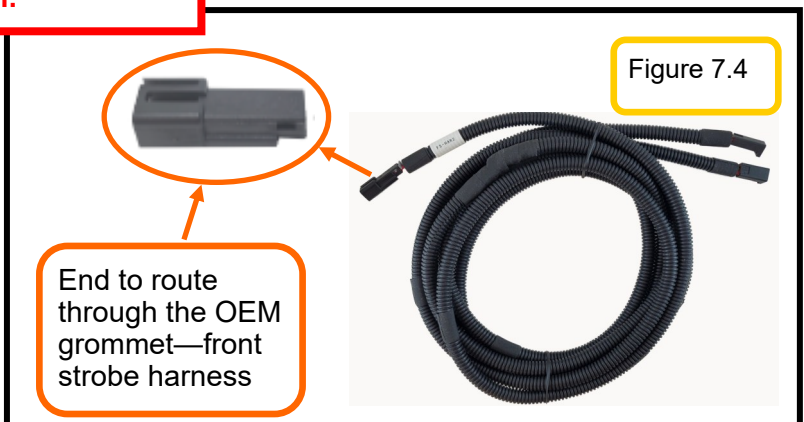

Power harness

Switch Harness



Figure 8.1



Figure 8.2



Figure 8.3

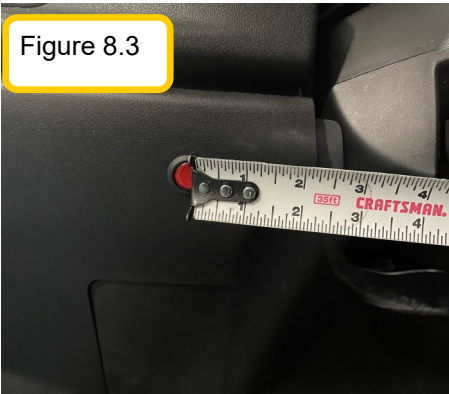

Switched power
12V Constant
Ground



Step 4: Locate the switch harness #67097

Connect the switch harness connector to the power harness in the kick panel area.

Step 5: Disassemble the knee bolster trim panel.

If there is NOT inverter with this install; Drill a hole 1.5" down measured from the edge of the trim panel (Figure 8.1) and 7" from the left trim edge (Figure 8.2) (Or measured 2.25" to the right edge: figure 8.3.) A hole diameter of 3/4" (19mm) is necessary to install the snap in switch (do not insert switch yet). Be sure the area behind the trim panel is clear before drilling.

If there is an inverter with this install, Move the switch to the right as needed.

Route the switch end of the switch harness up underneath the trim panel, through the switch hole. AVOID MOVING/ROTATING OBJECTS. Secure with zip ties.

Step 6: Connect the ground spade to the gold pin on the rocker switch

Connect the white battery power spade to the opposite terminal on the switch.

Connect the red spade to the middle pin.

Insert the switch into the hole and place the strobe/beacon decal (if supplied) around the switch.

Reassemble all trim and secure wiring. Figure 8.4.

Figure 8.4



Strobe Install—If Applicable

Strobe pictures are for reference only. Please refer to product structure/spec sheets for the actual strobes for the install.

Figure 9.1



Step 1: (If you are installing a beacon, follow these routing steps with the beacon harness)

Locate the rear strobe harness #67107.

Connect the rear strobe harness to the switch harness (one of the remaining unused connectors) in the driver's foot well. Figure 9.1.

Step 2:

Locate the driver's side door sill area. Figure 9.2.

Carefully remove the trim around the hood release handle by using a trim tool and removing the retraining screw underneath. Then remove the foot sill trim. Figures 9.3, 9.4, and 9.5.

Continue routing the harness down to the floor, under the sill trim, rearward to the partition. See figure 9.6 for the routing path.

Re-insert trim that was pulled up after routing.

Figure 9.2



Figure 9.5



Figure 9.3



Figure 9.6



Figure 9.4



Figure 10.1

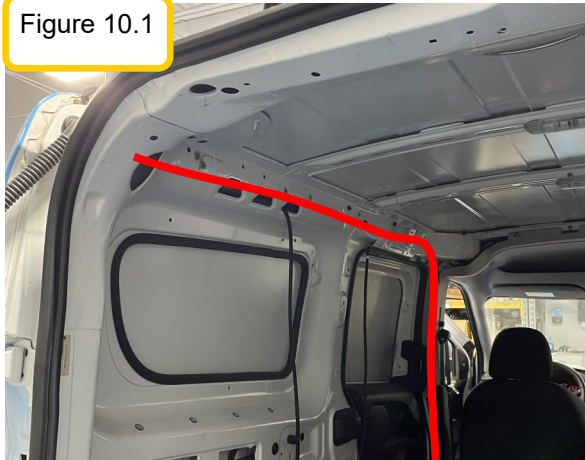

Step 3: Routing (Refer to routing diagrams at the beginning of the instructions)

Route the strobe harness up the backside of the partition, through the roof channels, and rearward following the OEM harness. Figure 10.1.

The strobe connections will be made in the D-pillar channels, so route the harness across the rear doors like shown in figure 10.2.

Route the strobe connector ends through the D-pillar channel after the holes have been drilled.

Figure 10.2

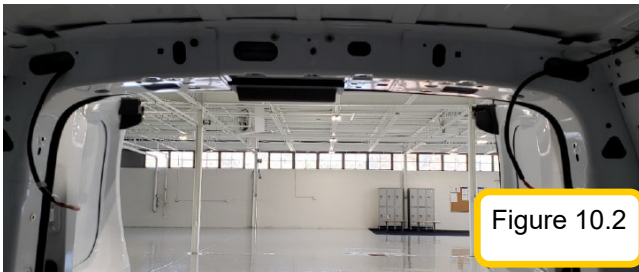

Step 4: Mounting Strobes

Locate the rear side doors (outside of van).

Use the strobe as a template to mark your needed holes. Place the strobe 3.75" above the brake light like shown in figure 10.3.



Figure 10.3

Drill a 7/16" hole in the van body for the wire pass through (center of strobe) and insert the provided grommet (65130).

Do this for both sides.

Step 5: Tape up the non-needed blue or yellow wire on the strobe.

Route the strobe harness down the D-pillar and make the strobe connections. Figure 10.4.

Do this for both sides. Use a small amount of silicone to seal the wiring.

Use a small drill bit to pilot the strobe mounting holes.

Place the strobes in their desired locations and fasten them onto the bumper with the supplied screws.

Figure 10.4.

*****TORQUE STROBES TO 10-IN-LB'S MAXIMUM*****

Repeat for the other side strobe.

Figure 10.4



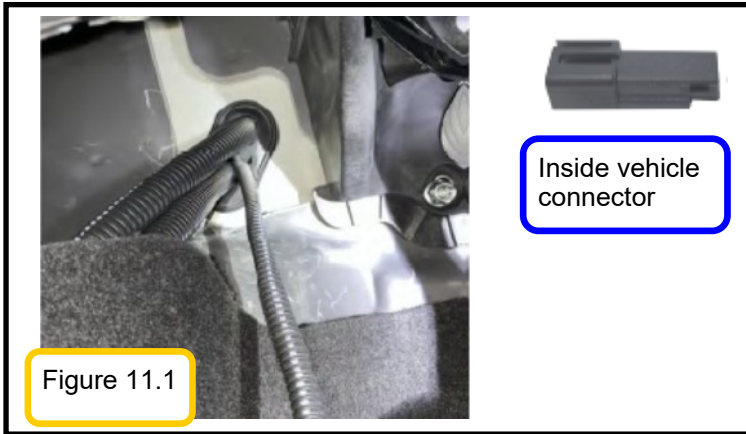

Step 5: Locate the front strobe harness #67102.

Start by routing the inside connector end of the harness to the firewall. This should be already routed through the grommet with the power harness and siliconed. If this is not done, please do this now. Refer to page 7 on the grommet and silicone needed.

Figures 11.1 and 11.2.

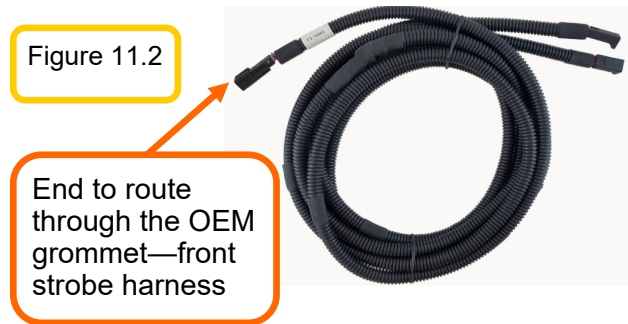

Connect the strobe harness to one of the un-used connectors on the switch harness.

Figure 11.3.

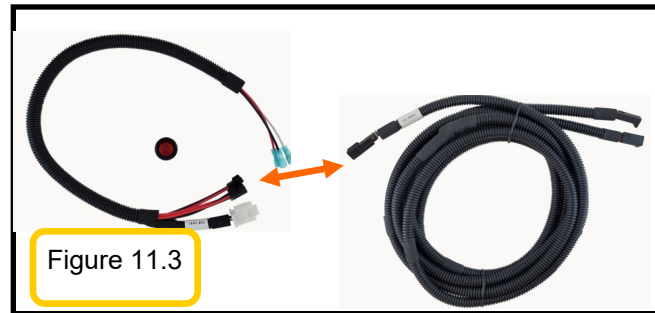

Step 6: Route the strobe connector ends to the each of the strobes. Strobe placements figure 11.4. Routing diagram figure 11.5.

Secure wiring with zip ties.

Be sure not to secure or route the harness anywhere near moving or hot objects.

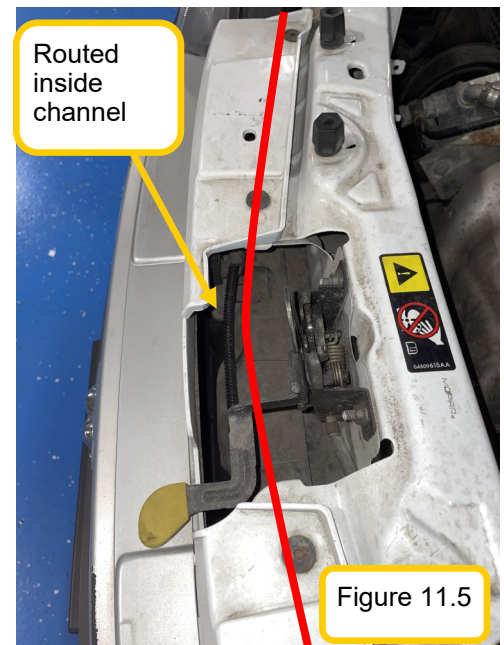
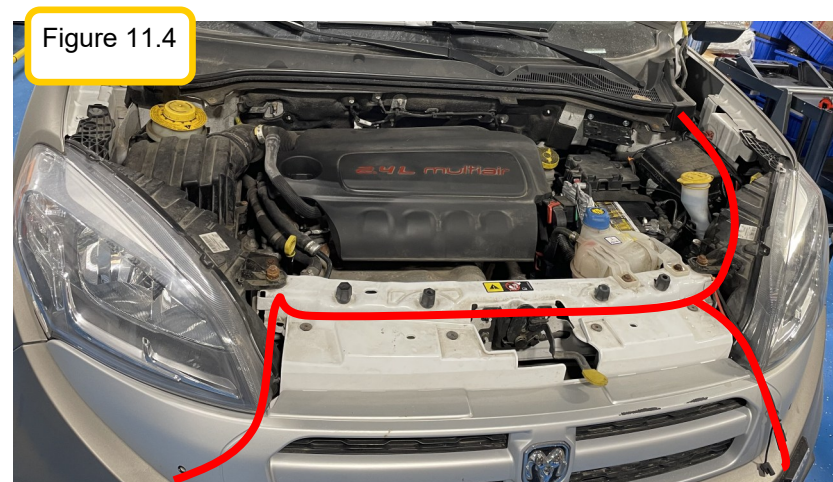

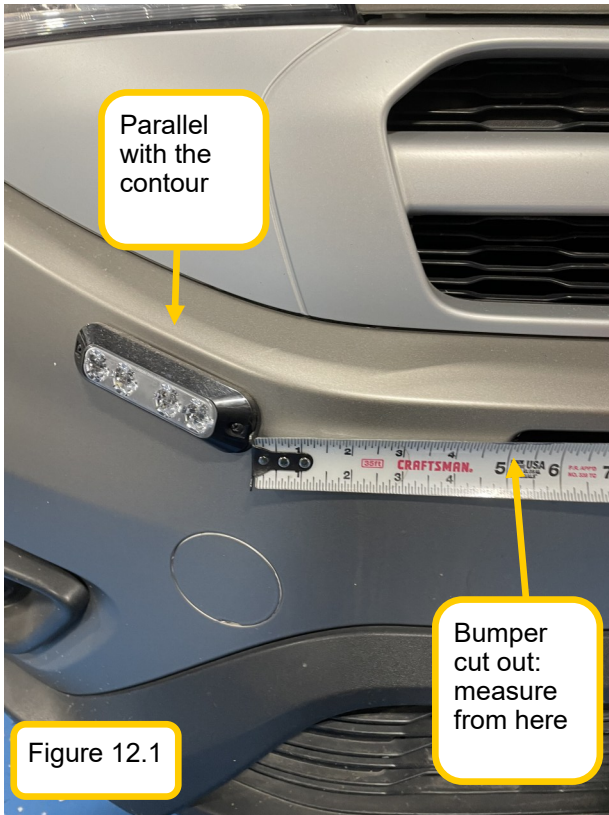

Step 7: Mounting Front Strobes

Locate the van front grill, passenger side.

Measure 5" left from the bumper cut out and place the strobe. Orientate the strobe so that it is parallel with the bumper contour as seen in figure 12.1.

Use the strobe as a template, mark the center hole location on the panel (for routing the wires through).

Drill a 7/16" hole for the wire pass through on the strobe.

Do this now for the driver's side.

Route the strobe harness connectors through the holes.

Connect the strobe to the strobe harness and tape up the non-needed blue or yellow wire.

Only silicone the hole the holes on the inside of the vehicle.

DO NOT SILI-CONE ON THE OUTSIDE OF THE VEHICLE.



Place the strobes in their desired locations and fasten them onto the grill with the strobe light supplied screws. Drill pilot holes for an easier installation. Figure 12.2.

*****TORQUE STROBES TO 10-IN-LB'S MAXIMUM*****

Repeat for the other side strobe.

Beacon Install—If Applicable

Beacon and mount pictures are for reference only. Please refer to product structure/spec sheets for the actual beacon/lightbar/mount for the install.

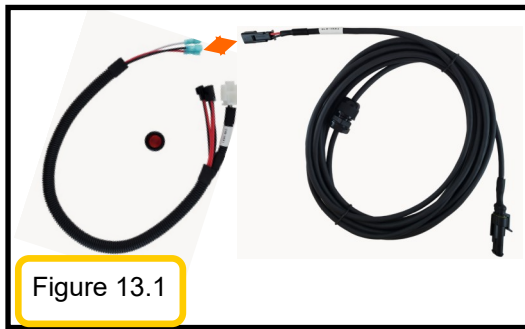

Figure 13.1

Step 1: Routing (Refer to routing diagrams at the beginning of the instructions)

Locate the beacon harness # 67112 or 67113.

Connect the harness to the switch harness (one of the remaining unused connectors) in the driver's foot well.

Figure 13.1.

Step 2:

Locate the driver's side door sill area.

Figure 13.2.



Figure 13.2

Carefully remove the trim around the hood release handle by using a trim tool and removing the retraining screw underneath. Then remove the foot sill trim. Figures 13.3, 13.4, and 13.5.

Continue routing the harness down to the floor, under the sill trim, rearward to the partition. See figure 13.5 for the routing path.

Re-insert trim that was pulled up after routing.

Route the strobe harness up the backside of the partition, through the roof channels, and rearward following the OEM harness. Figure 13.7.

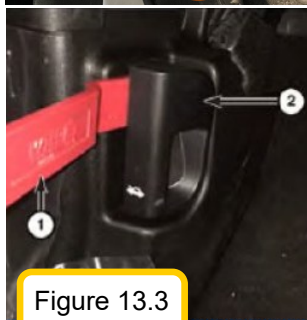

Figure 13.3

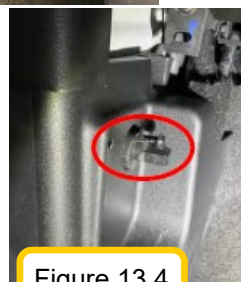

Figure 13.4

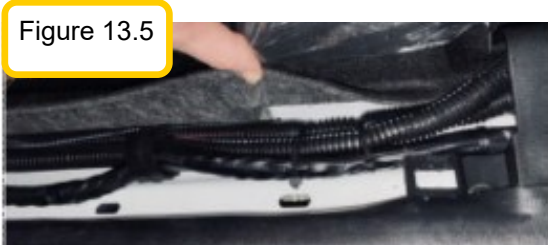

Figure 13.5

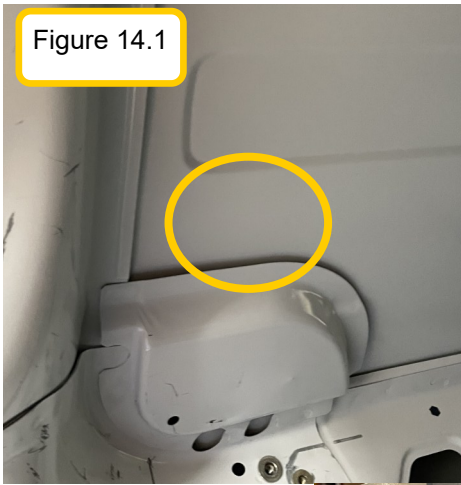

Figure 13.6



Figure 13.7

Figure 14.1



For ladder rack mounted beacon:

Step 1: Locate the rear driver's side D-pillar roof area. Center and mark a spot for the cable gland hole for the beacon harness. See Figure 14.1 yellow circle for hole reference. Be sure hole will not interfere with the ladder rack foot. You want to be around 1" away from the foot. Figure 14.2.

Drill a 5/8" (to fit the cable gland on the beacon harness) in the center for the wire pass through.

Route the beacon wire harness through the hole and insert the cable gland. Tighten the cable gland. Secure with zip-ties.

Figure 14.2



Step 2: Refer to next page if beacon does not have a connector on the wire ends. Locate the beacon, beacon cage, and mount.

Run the beacon wires through the tube of the mount before mounting.

Use the provided nut, screw, and washer to mount the cage and beacon to the mount. Figure 14.3.

Figure 14.3

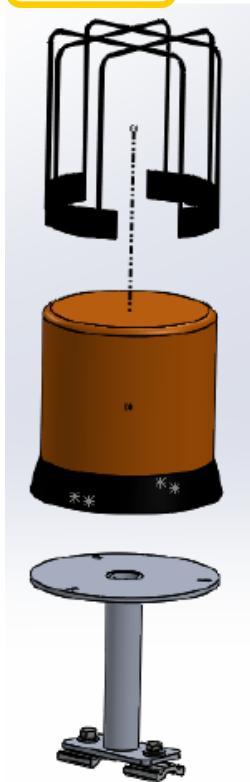
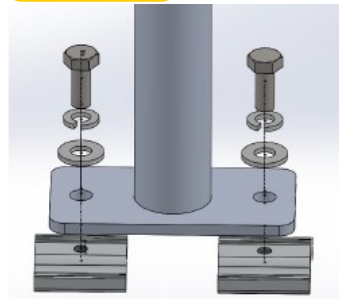

Figure 14.4



Assemble the beacon mount feet by inserting the bolt (FAS0799) through the lock washer (FAS0588) then flat washer (FAS0552) then through the foot into the slide. Do not tighten down at this point. Figure 14.4.

Step 3: Connect the beacon harness to the beacon now. You will need to remove the cap on the beacon harness. Tape up the un-needed yellow wire. Tuck the connector part of the harnesses up into the tube for easier routing.

Slide the beacon/mount to the center of the rail. Be cautious of the wire sliding through the rail. Figure 14.5.

Tighten the bolts once you have positioned the beacon. Figure 14.6.

Figure 14.5

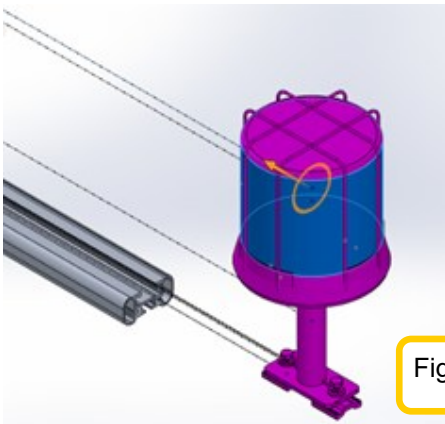

Figure 14.6

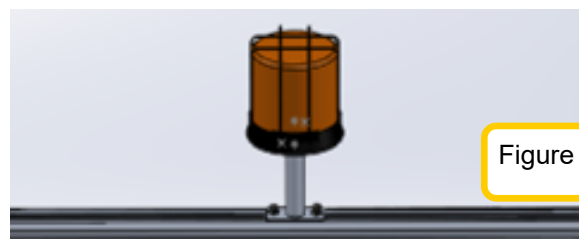

Figure 15.1



Figure 15.2



Figure 15.3



Figure 15.4



Figure 15.5

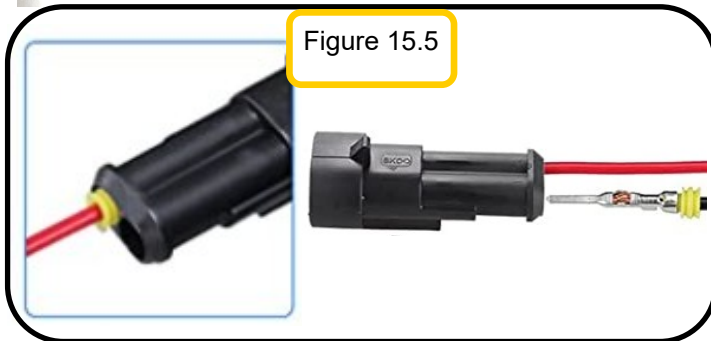

Figure 15.6

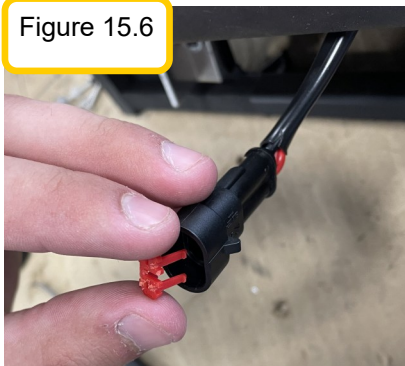
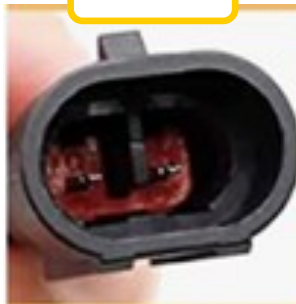

Figure 15.7



For beacon's without the connectors:

Locate the connector housing inside the lightbar/beacon box. Figure 15.1.

Note if it has a red insert inside the connector or not. Refer to figure 15.2 for red insert inside the connector.

Insert the lightbar wire terminals into the connector. **See steps below:**

In these steps be very careful to place the terminals into the correct side of the connector.

Line the red wire terminal up with cavity #1 and the black wire terminal up with cavity #2. Figure 15.3.

Note the connector has a "1" and a "2" noted on the connector (circled in red). Figure 15.4. The red wire will be inserted into the #1 cavity of the connector. The black wire will be inserted into the #2 cavity on the connector.

Be sure to align the terminal prongs up with the inside of the connector pin outs.

Carefully insert the terminals into their designated section. Figure 15.5.

Also be sure the terminals snap into position. You should feel or hear a click when they are correctly inserted.

Pull on the wiring to be sure the connectors have been inserted completely.

If not already done:

Insert the red plastic piece into the top end of the connector. This will also click into place. Figure 15.6 and 15.7.

Silicone the grommet/wiring.

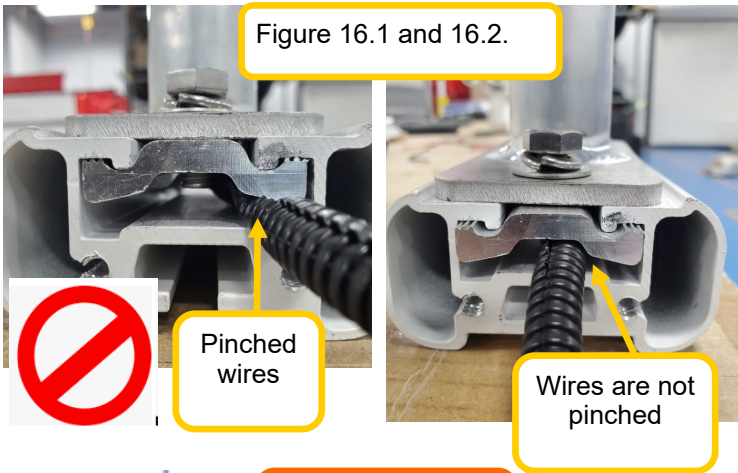

*****Be cautious the wires are not pinched after tightening the slides*****
See figures 16.1 and 16.2 for reference.

Step 4: Ladder Rack Routing

Option 1: (The preferred option)

Drill a 3/8" hole from the top channel to the bottom channel, 2" to the right of the where the foot mounts to the rail. See picture to the left for reference.

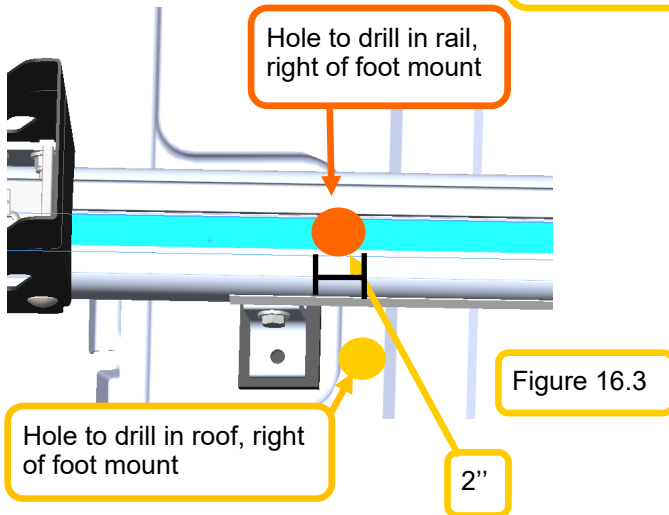

Route the wires in the top rail channel (before inserting the weather strip) to the drivers side area, through the hole in the rail, and down the foot to the hole in the roof. Figure 16.3.

Option 2: Drill a 3/8" hole from the top channel to the bottom channel directly under the beacon mount in the middle of the crossbow. Then route the wires through the hole to the bottom channel and down the channel to the end of the rail, drivers side.

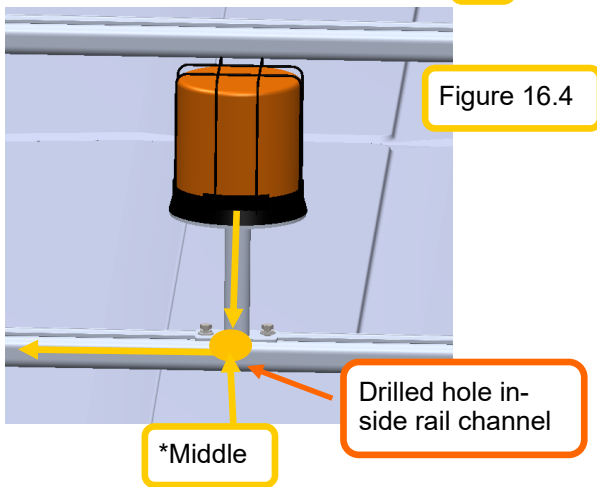

On 68" the rack, measure 34" from the end. On the 58" rack measure 29" from the end.

Use the tek screws (FAS0842) and nylon clips (66843) to secure the wiring under the utility rack.

Routing is shown in yellow in figure 16.4. The hole is drilled beneath the beacon from the top channel to bottom.

Where you route the wires will depend on what all options you are installing on the utility rack.

If you are installing a few accessories onto the rail that mount to the bottom channel, use the top channel for wire

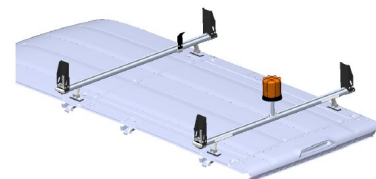
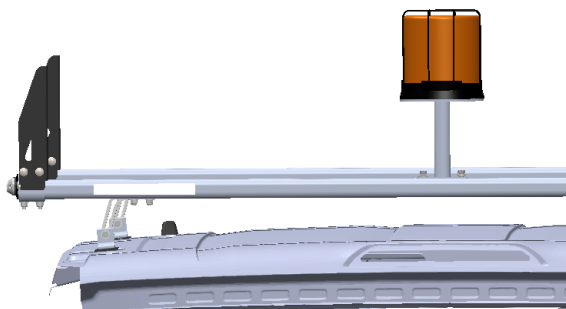

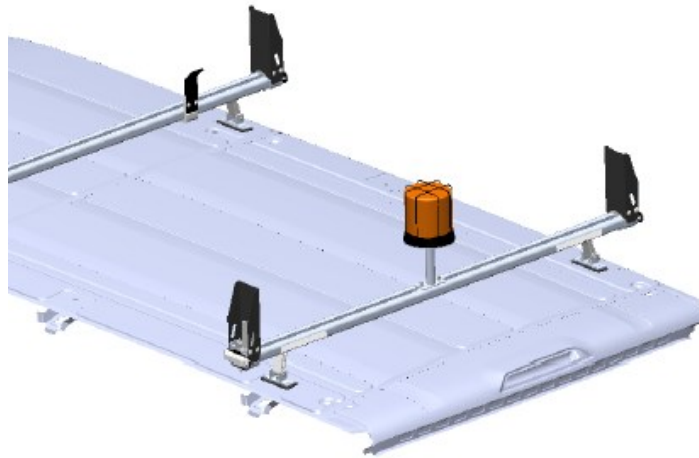

Insert the fuse into the inline-fuse holder on the power harness. The install is now complete. Secure all wiring with zip ties. Re-attach all trim. Re-assure all pass through holes have been silicone. Double check the functionality of the lights and switches.

PART NUMBER

13905-0

ITEM DESCRIPTION: WIRE TIE, NYLON 40Lb, 8.5" BLACK



MANUFACTURER: WAYTEK, INC. or equivalent
MANUFACTURERS PART NUMBER: 21093M or 21093C

SPECIFICATIONS: STANDARD CABLE TIE
 BLACK, NYLON
 8-1/2" LONG
 TENSILE STRENGTH: 40.0 LBS
 21093M = 1,000 quantity
 21093C = 100 quantity

SPECIAL NOTES: PART NUMBER IS BLACK.

SUPPLIED BY: THIS ITEM IS ADRIAN AVAILABLE!

PURCHASED PRODUCT DATA SHEET (PPDS)

THIS DRAWING/INFORMATION IS THE PROPERTY OF ADRIAN STEEL COMPANY AND IS NOT TO BE USED IN ANY MANNER THAT IS DETRIMENTAL TO THE INTEREST OF ADRIAN STEEL. COPYRIGHTS AND OR PATENTS THAT MAY BE THE PROPERTY OF APPLICABLE OWNERS MAY PROTECT INFORMATION AND/OR DRAWINGS OF SUPPLIED PRODUCTS.



ADRIAN STEEL
VAN AND PICKUP EQUIPMENT

906 JAMES STREET
ADRIAN, MI 49221
517-265-6194
WWW.ADRIANSTEEL.COM



WHEN INSTALLING EQUIPMENT IN OR ON VEHICLES CHECK FOR FUEL TANKS, FUEL LINES, CONTROL LINES AND ELECTRICAL WIRING BEFORE DRILLING! ALWAYS USE DRILL BITS WITH INTEGRAL STOPS WHENEVER POSSIBLE!

DRAWN BY MDG	DATE DRAWN 10/26/2006
ECN NUMBER 18021	ECN DATE 11/13/2015
PART WEIGHT 0.01 LBS.	REV. LEVEL D
PART NUMBER 13905-0	

PART NUMBER

26618-0

ITEM DESCRIPTION: SILICONE, 1oz. TUBE



SPECIFICATIONS: SU5005 RTV SILICONE
1oz. TUBE
CLEAR OR EQUIVALENT
SELF PIERCING CAP

SPECIAL NOTES:

SUPPLIED BY: THIS ITEM IS ADRIAN AVAILABLE!

PURCHASED PRODUCT DATA SHEET (PPDS)

THIS DRAWING/INFORMATION IS THE PROPERTY OF ADRIAN STEEL COMPANY AND IS NOT TO BE USED IN ANY MANNER THAT IS DETRIMENTAL TO THE INTEREST OF ADRIAN STEEL. COPYRIGHTS AND OR PATENTS THAT MAY BE THE PROPERTY OF APPLICABLE OWNERS MAY PROTECT INFORMATION AND/OR DRAWINGS OF SUPPLIED PRODUCTS.



ADRIAN STEEL
VAN AND PICKUP EQUIPMENT

906 JAMES STREET
ADRIAN, MI 49221
517-265-6194

WWW.ADRIANSTEEL.COM

! CAUTION !

WHEN INSTALLING EQUIPMENT IN OR ON VEHICLES CHECK FOR FUEL TANKS, FUEL LINES, CONTROL LINES AND ELECTRICAL WIRING BEFORE DRILLING! ALWAYS USE DRILL BITS WITH INTEGRAL STOPS WHENEVER POSSIBLE!

DRAWN BY
JLC

DATE DRAWN
7/21/2001

ECN NUMBER
16551

ECN DATE
7/22/2014

PART WEIGHT
0.02 LBS.

REV. LEVEL
C

PART NUMBER
26618-0

PART NUMBER

26618-0

ITEM DESCRIPTION: SILICONE, 1oz. TUBE



SPECIFICATIONS: SU5005 RTV SILICONE
1oz. TUBE
CLEAR OR EQUIVALENT
SELF PIERCING CAP

SPECIAL NOTES:

SUPPLIED BY: THIS ITEM IS ADRIAN AVAILABLE!

PURCHASED PRODUCT DATA SHEET (PPDS)

THIS DRAWING/INFORMATION IS THE PROPERTY OF ADRIAN STEEL COMPANY AND IS NOT TO BE USED IN ANY MANNER THAT IS DETRIMENTAL TO THE INTEREST OF ADRIAN STEEL. COPYRIGHTS AND OR PATENTS THAT MAY BE THE PROPERTY OF APPLICABLE OWNERS MAY PROTECT INFORMATION AND/OR DRAWINGS OF SUPPLIED PRODUCTS.



ADRIAN STEEL
VAN AND PICKUP EQUIPMENT

906 JAMES STREET
ADRIAN, MI 49221
517-265-6194

WWW.ADRIANSTEEL.COM

CAUTION

WHEN INSTALLING EQUIPMENT IN OR ON VEHICLES CHECK FOR FUEL TANKS, FUEL LINES, CONTROL LINES AND ELECTRICAL WIRING BEFORE DRILLING! ALWAYS USE DRILL BITS WITH INTEGRAL STOPS WHENEVER POSSIBLE!

DRAWN BY
JLC

DATE DRAWN
7/21/2001

ECN NUMBER
16551

ECN DATE
7/22/2014

PART WEIGHT
0.02 LBS.

REV. LEVEL
C

PART NUMBER
26618-0

PART NUMBER
32649-0

ITEM DESCRIPTION: BATTERY BOLT EXTENDERS

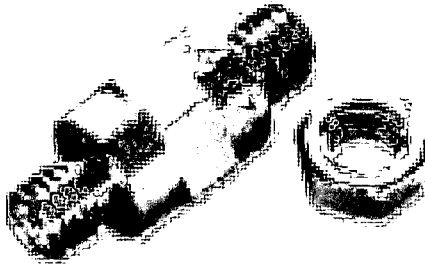

MANUFACTURER: WAYTEK WIRE
MANUFACTURERS PART NUMBER: 36244

SPECIFICATIONS: BATTERY BOLT EXTENDER FOR SIDE POST APPLICATIONS.
POWER HOOK-UP FOR DIRECT CONNECTIONS TO BATTERY.
SOLID BRASS BOLT EXTENDER AND PLATED STEEL NUT.

SPECIAL NOTES:

SUPPLIED BY: THIS ITEM IS INSTALLER SUPPLIED!

PURCHASED PRODUCT DATA SHEET (PPDS)

THIS DRAWING/INFORMATION IS THE PROPERTY OF ADRIAN STEEL COMPANY AND IS NOT TO BE USED IN ANY MANNER THAT IS DETRIMENTAL TO THE INTEREST OF ADRIAN STEEL. COPYRIGHTS AND OR PATENTS THAT MAY BE THE PROPERTY OF APPLICABLE OWNERS MAY PROTECT INFORMATION AND/OR DRAWINGS OF SUPPLIED PRODUCTS.



ADRIAN STEEL
VAN AND PICKUP EQUIPMENT

906 JAMES STREET
ADRIAN, MI 49221
517-265-6194

WWW.ADRIANSTEEL.COM



CAUTION
WHEN INSTALLING EQUIPMENT IN OR ON VEHICLES CHECK FOR FUEL TANKS, FUEL LINES, CONTROL LINES AND ELECTRICAL WIRING BEFORE DRILLING! ALWAYS USE DRILL BITS WITH INTEGRAL STOPS WHENEVER POSSIBLE!

DRAWN BY
MDG

DATE DRAWN
03/29/2006

ECN NUMBER
8993

ECN DATE
03/29/2006

PART WEIGHT
0.05 LBS.

REV. LEVEL
PCS

PART NUMBER

32649-0

ITEM DESCRIPTION: STROBE SWITCH DECAL SET

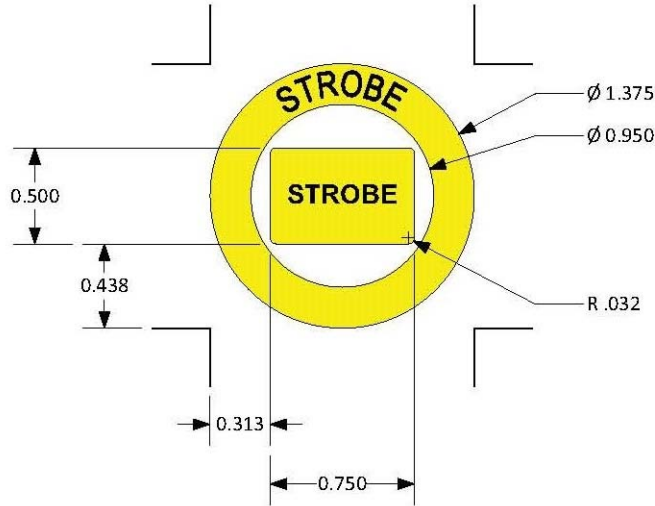

MANUFACTURER: VANNER
MANUFACTURERS PART NUMBER: TBD

SPECIFICATIONS: (1) Circular Yellow Decal (ID=0.950", OD=1.375") with "STROBE" in black letters
(1) Rectangular Yellow Decal (H=0.500", L=0.750") with "STROBE" in black letters

SPECIAL NOTES: For round rocker switch (OD=0.780") and Ford Transit Upfitter Switches.

SUPPLIED BY: THIS ITEM IS ADRIAN AVAILABLE!

PURCHASED PRODUCT DATA SHEET (PPDS)

THIS DRAWING/INFORMATION IS THE PROPERTY OF ADRIAN STEEL COMPANY AND IS NOT TO BE USED IN ANY MANNER THAT IS DETRIMENTAL TO THE INTEREST OF ADRIAN STEEL. COPYRIGHTS AND OR PATENTS THAT MAY BE THE PROPERTY OF APPLICABLE OWNERS MAY PROTECT INFORMATION AND/OR DRAWINGS OF SUPPLIED PRODUCTS.



**906 JAMES STREET
ADRIAN, MI 49221
517-265-6194
WWW.ADRIANSTEEL.COM**



CAUTION
WHEN INSTALLING EQUIPMENT IN OR ON VEHICLES CHECK FOR FUEL TANKS, FUEL LINES, CONTROL LINES AND ELECTRICAL WIRING BEFORE DRILLING! ALWAYS USE DRILL BITS WITH INTEGRAL STOPS WHENEVER POSSIBLE!

DRAWN BY RJB	DATE DRAWN 11/15/2017
ECN NUMBER XXXX	ECN DATE XXXXXX
PART WEIGHT 0.02 LBS.	REV. LEVEL A
PART NUMBER 55073	

REVISIONS			
REV	DESCRIPTION	DATE	REAE/CO

- NOTES:
1. MATERIAL : .002 YELLOW POLYESTER
 2. ARTWORK FROM D91XXXX-A PAGE 1, PMS BLACK
 3. .001 OVERLAMINATE
 4. ADHESIVE BACKED

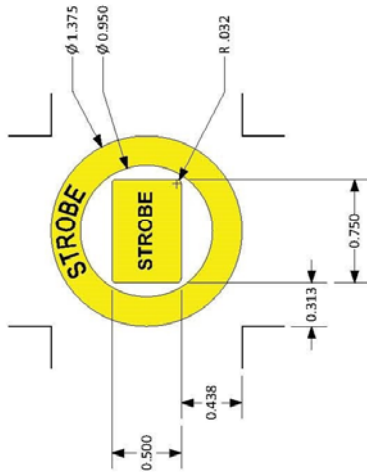

VANNER INCORPORATED HILLIARD, OHIO USA	
TOL. LABEL/METAL .x ± .025 .xx ± .015 .xxx ± .005	TITLE: LABEL, STROBE TXT, .95ID ROUND SWITCH
TOL. CABLES .xxx ± .25	DRAWING/ PART NO. D01XXXX
DRNDATE MEO 11/14/17	SHEET 1 OF 1 REV A
SCALE: NONE	REAE/CO NO.: XXXX
THIS DRAWING AND ALL INFORMATION CONTAINED HEREIN IS THE PROPERTY OF VANNER INC. AND MAY NOT BE COPIED, REPRODUCED OR DIVULGED TO UNAUTHORIZED PERSONS WITHOUT THE EXPRESS WRITTEN CONSENT OF VANNER INC. IT IS PROVIDED SOLELY FOR THE CONVENIENCE OF THE USER AND SHALL BE RETURNED UPON REQUEST.	

PART NUMBER
55073

THIS DRAWING/INFORMATION IS THE PROPERTY OF ADRIAN STEEL COMPANY AND IS NOT TO BE USED IN ANY MANNER THAT IS DETRIMENTAL TO THE INTEREST OF ADRIAN STEEL. COPYRIGHTS AND OR PATENTS THAT MAY BE THE PROPERTY OF APPLICABLE OWNERS MAY PROTECT INFORMATION AND/OR DRAWINGS OF SUPPLIED PRODUCTS.



906 JAMES STREET
 ADRIAN, MI 49221
 517-265-6194
 WWW.ADRIANSTEEL.COM



WHEN INSTALLING EQUIPMENT IN OR ON VEHICLES CHECK FOR FUEL TANKS, FUEL LINES, CONTROL LINES AND ELECTRICAL WIRING BEFORE DRILLING! ALWAYS USE DRILL BITS WITH INTEGRAL STOPS WHENEVER POSSIBLE!

DRAWN BY RJB	DATE DRAWN 11/15/2017
ECN NUMBER XXXX	ECN DATE XXXXXXX
PART WEIGHT 0.02 LBS.	REV. LEVEL A
PART NUMBER 55073	

LOC | QTY | Part # | Description | Size

Material: IJ39 | Lamination: 8518

1: 6039597.Strobe Switch-1.52" x 2.07"



Note: Part will not be weeded, just cut.

Kit# 8001872 | Adrian Steel Part # 55073

06/01/2023 • JY

© 2022 DISTYLL Graphics Solutions. All rights reserved.

ASCO REV.1 6/14/2023

 FINAL DESIGN	CLIENT NAME:		Switch Decals		O-ID: O15319-1
	Adrian Steel				Rev #: XXXX
	DATE:	DESIGNER:			Opt #: A
O5/31/2023	TRN				

Please check information to confirm accurate vehicle specifications.

CLEANING INSTRUCTIONS All surfaces must be considered contaminated. Clean the vehicle surface immediately before applying the film. Dust and other contaminants can collect quickly on the surface and prevent the film from adhering properly. Even a freshly painted surface can collect dust before graphics can be applied.

For the best success with the films recommended for vehicle graphics, always apply the graphics when the air and vehicle surface are both above 60°F (16°C) and below 90°F (32°C) before beginning the installation.

PURCHASED COMPONENT KEY FEATURES

DESCRIPTION OF REQUIREMENTS

DIMENSIONAL REQUIREMENTS (AS SHOWN ON DRAWING)

N/A

LOAD/RATING REQUIREMENT

N/A

MATERIAL REQUIREMENT

N/A

PACKAGING REQUIREMENT

N/A

OTHER REQUIREMENTS

Bill of Materials				
Id	Type	Manufacturer	Part Number	Quantity
1	Wire		12 AWG Red GXL	2040 mm
2	Wire		12 AWG Black GXL	2040 mm
3	Fuse Holder	Egis Mobile Electric	901028	1
4	Connector	TE Connectivity	1-480699-0	1
5	Contact	TE Connectivity	640309-3	2
6	Ring Terminal	Molex	19164-0068	2
7	Corrugated Tubing		0.25" Nylon Split Wall	700 mm
8	Corrugated Tubing		10mm Nylon Split Wall	1690 mm
9	Grommet		14mm Grommet	1
10	Label		Heat Shrink Style Label	1

Coverings	
Id	Assembly
[7]	
[8]	

Notes	
①	Lock Tape Loom with Tesa 51036
②	Add 15A ATO/ATC Fuse
③	Add rubber grommet over harness loom; 150mm behind C2

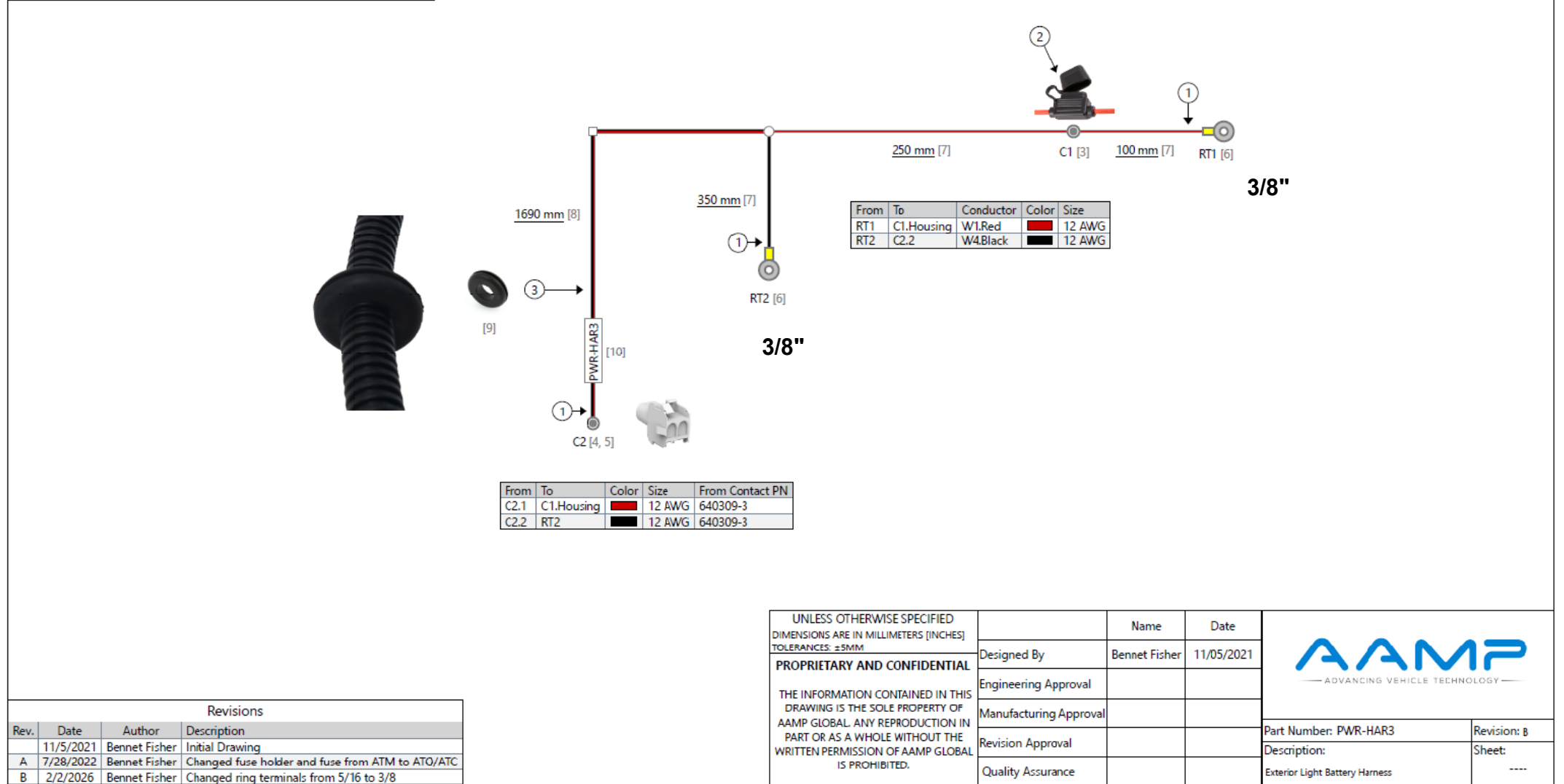

Revisions			
Rev.	Date	Author	Description
	11/5/2021	Bennet Fisher	Initial Drawing
A	7/28/2022	Bennet Fisher	Changed fuse holder and fuse from ATM to ATO/ATC
B	2/2/2026	Bennet Fisher	Changed ring terminals from 5/16 to 3/8

UNLESS OTHERWISE SPECIFIED DIMENSIONS ARE IN MILLIMETERS [INCHES] TOLERANCES: ±5MM		Name	Date
PROPRIETARY AND CONFIDENTIAL THE INFORMATION CONTAINED IN THIS DRAWING IS THE SOLE PROPERTY OF AAMP GLOBAL. ANY REPRODUCTION IN PART OR AS A WHOLE WITHOUT THE WRITTEN PERMISSION OF AAMP GLOBAL IS PROHIBITED.	Designed By	Bennet Fisher	11/05/2021
	Engineering Approval		
	Manufacturing Approval		
	Revision Approval		
	Quality Assurance		

Part Number: PWR-HAR3 Revision: B
Description: Exterior Light Battery Harness Sheet: ----

THIS DRAWING IS THE PROPERTY OF ADRIAN STEEL COMPANY AND IS NOT TO BE USED IN ANY MANNER DETRIMENTAL TO THE INTERESTS OF ADRIAN STEEL COMPANY

TOLERANCES & INSPECTION		
UNLESS OTHERWISE SPECIFIED		
ALL BEND ANGLES ARE 90 DEGREES		
ALL DIMENSIONS ARE IN INCHES.		
REFERENCE DIMENSIONS (X.XXX) DO NOT REQUIRE INSPECTION		
FEATURES	HOLES/SLOTS	ANGLES
0.0 = ± .125	0.0 = ± .062	0° = ± 2°
0.00 = ± .062	0.00 = ± .031	0.0° = ± 1°
0.000 = ± .031	0.000 = ± .015	
Material Thickness: per ASTM Std. Weld Callouts per AWS		

RELEASE & REVISIONS	
INITIAL ECN:	25378
CURRENT ECN:	29126
ECN DESCRIPTION:	INCREASE RING TERMINALS TO 3/8"
REVISED BY:	MLH

PURCHASED COMPONENT

REFERENCED SUPPLIER AND/OR MANUFACTURER
AAMP GLOBAL

REFERENCED SUPPLIER AND/OR MANUFACTURER PART NUMBER
67094 OR PWR-HAR3

COLOR (ONLY LIST IF COLOR SPECIFIC)
NO

COMODITY ITEM (Y/N) (YES = ALL DIMENSIONS AND NOTES ARE REFERENCE)
(NOTE: DIMENSIONS AND FEATURES MAY VARY FOR A COMODITY ITEM.)
NO

PRINTED DOCUMENT IS UNCONTROLLED

Sheet 1 of 1

PART / PRODUCT IDENTIFICATION		
	ADRIAN STEEL®	ADRIAN STEEL COMPANY 906 JAMES STREET, ADRIAN, MI 49221
MAT'L USED: PURCHASED	DESIGNED BY: E.BURKE	REVISION LEVEL B
DESCRIPTION: POWER HARNESS EXTERIOR 3		
WEIGHT (Lbs.): 0.2	SEGMENT CODE: ELE	PART NUMBER: 67094

Bill of Materials				
Id	Type	Manufacturer	Part Number	Quantity
1	Wire		12 AWG Red GXL	2040 mm
2	Wire		12 AWG Black GXL	2040 mm
3	Fuse Holder	Egis Mobile Electric	901028	1
4	Connector	TE Connectivity	1-480699-0	1
5	Contact	TE Connectivity	640309-3	2
6	Ring Terminal	Molex	19164-0068	2
7	Corrugated Tubing		0.25" Nylon Split Wall	700 mm
8	Corrugated Tubing		10mm Nylon Split Wall	1690 mm
9	Grommet		14mm Grommet	1
10	Label		Heat Shrink Style Label	1

Coverings	
Id	Assembly
[7]	
[8]	

Notes	
①	Lock Tape Loom with Tesa 51036
②	Add 15A ATO/ATC Fuse
③	Add rubber grommet over harness loom; 150mm behind C2

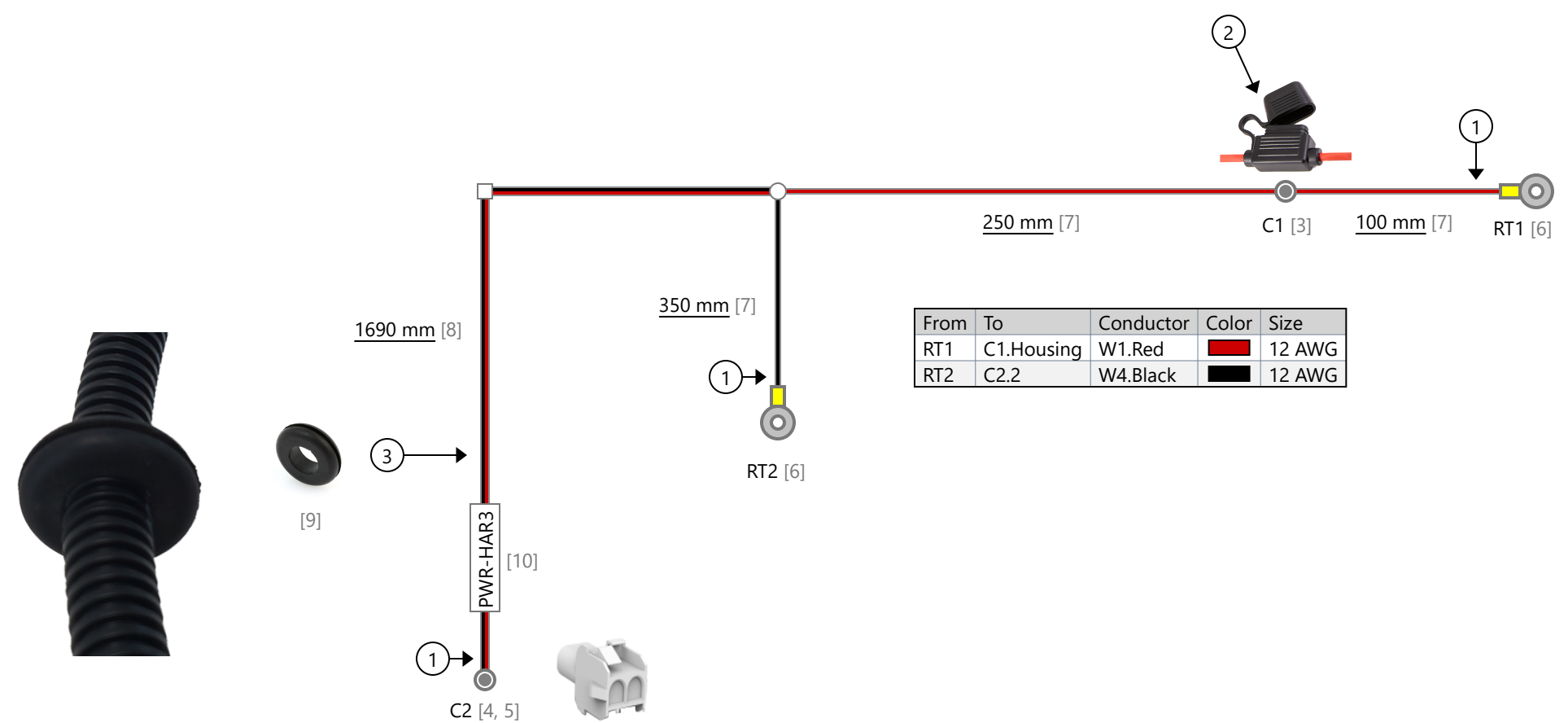

From	To	Conductor	Color	Size
RT1	C1.Housing	W1.Red	■	12 AWG
RT2	C2.2	W4.Black	■	12 AWG

From	To	Color	Size	From Contact PN
C2.1	C1.Housing	■	12 AWG	640309-3
C2.2	RT2	■	12 AWG	640309-3

Revisions			
Rev.	Date	Author	Description
	11/5/2021	Bennet Fisher	Initial Drawing
A	7/28/2022	Bennet Fisher	Changed fuse holder and fuse from ATM to ATO/ATC
B	2/2/2026	Bennet Fisher	Changed ring terminals from 5/16 to 3/8

<p>UNLESS OTHERWISE SPECIFIED DIMENSIONS ARE IN MILLIMETERS [INCHES] TOLERANCES: ±5MM</p> <p>PROPRIETARY AND CONFIDENTIAL</p> <p>THE INFORMATION CONTAINED IN THIS DRAWING IS THE SOLE PROPERTY OF AAMP GLOBAL. ANY REPRODUCTION IN PART OR AS A WHOLE WITHOUT THE WRITTEN PERMISSION OF AAMP GLOBAL IS PROHIBITED.</p>	Name	Date		
	Designed By	Bennet Fisher		11/05/2021
	Engineering Approval			
	Manufacturing Approval			
	Revision Approval			
Quality Assurance				
Part Number: PWR-HAR3		Revision: B		
Description: Exterior Light Battery Harness		Sheet: ----		

PURCHASED COMPONENT KEY FEATURES

DESCRIPTION OF REQUIREMENTS

DIMENSIONAL REQUIREMENTS (AS SHOWN ON DRAWING)

N/A

LOAD/RATING REQUIREMENT

N/A

MATERIAL REQUIREMENT

N/A

PACKAGING REQUIREMENT

N/A

OTHER REQUIREMENTS

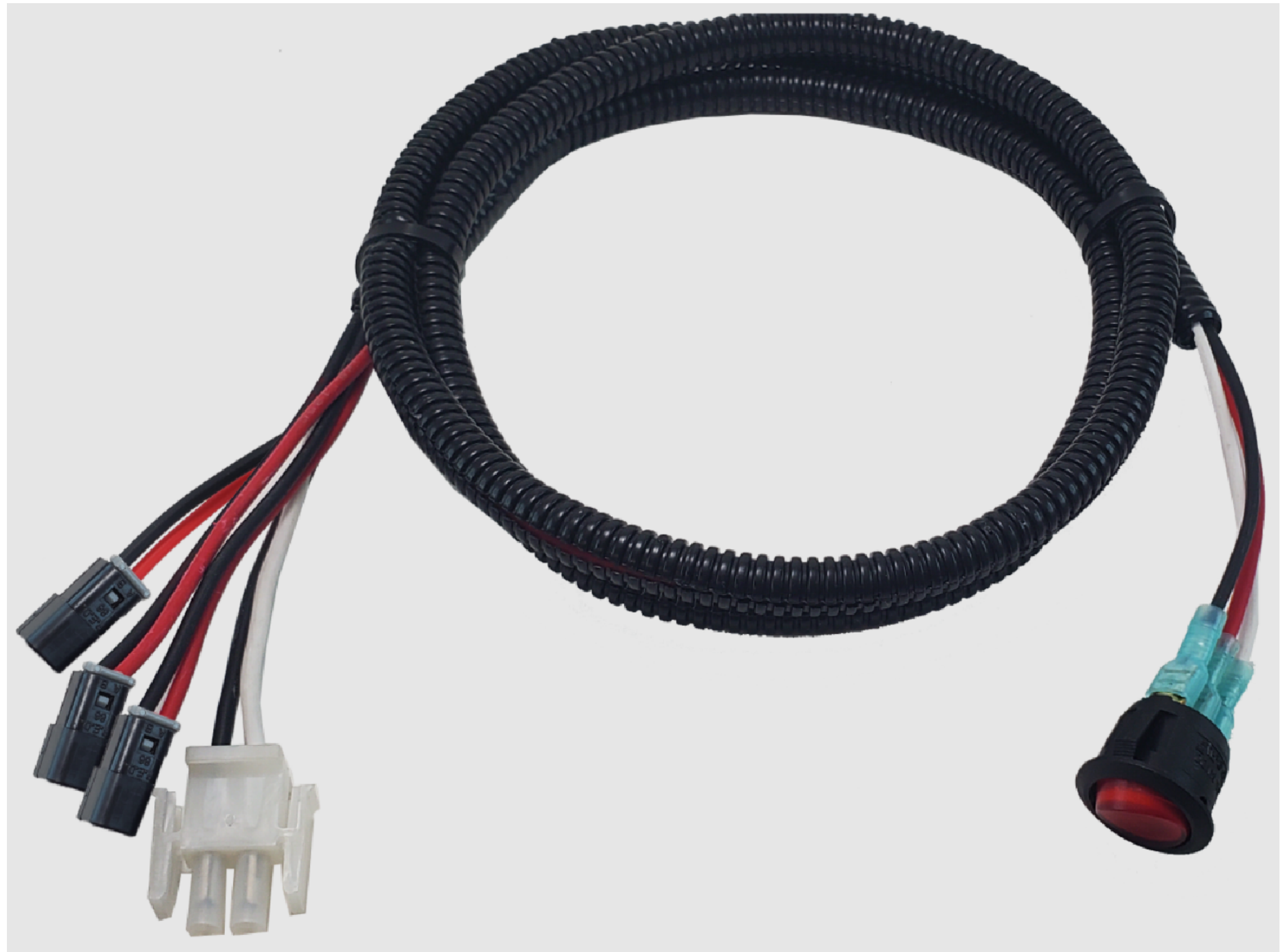

THIS DRAWING IS THE PROPERTY OF ADRIAN STEEL COMPANY AND IS NOT TO BE USED IN ANY MANNER DETRIMENTAL TO THE INTERESTS OF ADRIAN STEEL COMPANY

TOLERANCES & INSPECTION

UNLESS OTHERWISE SPECIFIED

ALL BEND ANGLES ARE 90 DEGREES

ALL DIMENSIONS ARE IN INCHES.

REFERENCE DIMENSIONS (X.XXX)
DO NOT REQUIRE INSPECTION

FEATURES	HOLES/SLOTS	ANGLES
0.0 = ± .125	0.0 = ± .062	0° = ± 2°
0.00 = ± .062	0.00 = ± .031	0.0° = ± 1°
0.000 = ± .031	0.000 = ± .015	

Material Thickness: per ASTM Std.
Weld Callouts per AWS

RELEASE & REVISIONS

INITIAL ECN: **25378**

CURRENT ECN: **25378**

ECN DESCRIPTION:

RELEASE FOR PRODUCTION

REVISED BY:

PURCHASED COMPONENT

REFERENCED SUPPLIER AND/OR MANUFACTURER

AAMP GLOBAL

REFERENCED SUPPLIER AND/OR MANUFACTURER PART NUMBER

SSW-HAR2 OR 67098

COLOR (ONLY LIST IF COLOR SPECIFIC)

COMODITY ITEM (Y/N) (YES = ALL DIMENSIONS AND NOTES ARE REFERENCE)
(NOTE: DIMENSIONS AND FEATURES MAY VARY FOR A COMODITY ITEM.)

NO

PRINTED DOCUMENT IS UNCONTROLLED

Sheet 1 of 1

PART / PRODUCT IDENTIFICATION



ADRIAN STEEL®

ADRIAN STEEL COMPANY
906 JAMES STREET, ADRIAN, MI 49221

REVISION LEVEL

A

MAT'L USED: **PURCHASED**

DESIGNED BY: **E.BURKE**

DESCRIPTION: **SWITCH HARNESS 2 EXTERIOR LIGHTING**

WEIGHT (Lbs.): **0.2**

SEGMENT CODE: **ELE**

PART NUMBER: **67098**

Coverings	
Id	Assembly
[12]	

Notes	
①	Lock Tape Loom with Tesa 51608
②	75mm between end of loom and Quick Connects

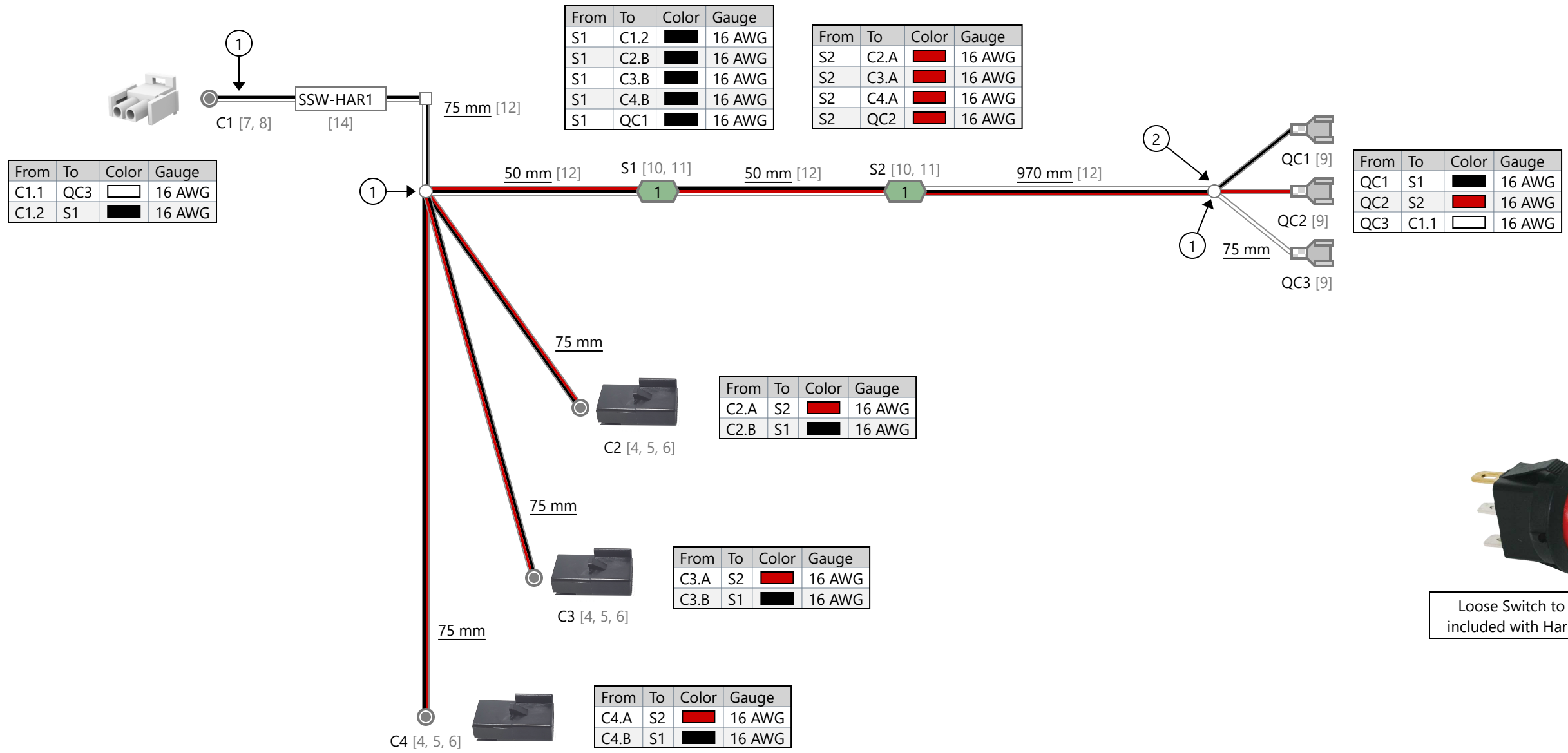

Revisions			
Rev.	Date	Author	Description
A	11/5/2021	Bennet Fisher	Initial Drawing

UNLESS OTHERWISE SPECIFIED DIMENSIONS ARE IN MILLIMETERS (INCHES) TOLERANCES: ±5MM PROPRIETARY AND CONFIDENTIAL THE INFORMATION CONTAINED IN THIS DRAWING IS THE SOLE PROPERTY OF AAMP GLOBAL. ANY REPRODUCTION IN PART OR AS A WHOLE WITHOUT THE WRITTEN PERMISSION OF AAMP GLOBAL IS PROHIBITED.	Designed By	Bennet Fisher	11/5/2021	 Part Number: SSW-HAR2 Description: Strobe Switch Harness - 3 Outputs	Revision: ----
	Engineering Approval	----	----		Sheet:
	Manufacturing Approval	----	----		1 of 1
	Revision Approval	----	----		
	Quality Assurance	----	----		

PURCHASED COMPONENT KEY FEATURES

DESCRIPTION OF REQUIREMENTS

DIMENSIONAL REQUIREMENTS (AS SHOWN ON DRAWING)

N/A

LOAD/RATING REQUIREMENT

N/A

MATERIAL REQUIREMENT

N/A

PACKAGING REQUIREMENT

N/A

OTHER REQUIREMENTS



THIS DRAWING IS THE PROPERTY OF ADRIAN STEEL COMPANY AND IS NOT TO BE USED IN ANY MANNER DETRIMENTAL TO THE INTERESTS OF ADRIAN STEEL COMPANY

TOLERANCES & INSPECTION

UNLESS OTHERWISE SPECIFIED

ALL BEND ANGLES ARE 90 DEGREES

ALL DIMENSIONS ARE IN INCHES.

REFERENCE DIMENSIONS (X.XXX)
DO NOT REQUIRE INSPECTION

FEATURES	HOLES/SLOTS	ANGLES
0.0 = ± .125	0.0 = ± .062	0° = ± 2°
0.00 = ± .062	0.00 = ± .031	0.0° = ± 1°
0.000 = ± .031	0.000 = ± .015	

Material Thickness: per ASTM Std.
Weld Callouts per AWS

RELEASE & REVISIONS

INITIAL ECN: **25378**

CURRENT ECN: **25378**

ECN DESCRIPTION:

RELEASE FOR PRODUCTION

REVISED BY:

PURCHASED COMPONENT

REFERENCED SUPPLIER AND/OR MANUFACTURER

AAMP GLOBAL

REFERENCED SUPPLIER AND/OR MANUFACTURER PART NUMBER

FS-HAR1 OR 67101

COLOR (ONLY LIST IF COLOR SPECIFIC)

COMODITY ITEM (Y/N) (YES = ALL DIMENSIONS AND NOTES ARE REFERENCE)
(NOTE: DIMENSIONS AND FEATURES MAY VARY FOR A COMODITY ITEM.)

NO

PRINTED DOCUMENT IS UNCONTROLLED

Sheet 1 of 1

PART / PRODUCT IDENTIFICATION



ADRIAN STEEL®

ADRIAN STEEL COMPANY
906 JAMES STREET, ADRIAN, MI 49221

REVISION LEVEL

A

MAT'L USED: **PURCHASED**

DESIGNED BY: **E.BURKE**

DESCRIPTION: **FRONT STROBE HARNESS 1**

WEIGHT (Lbs.): **0.2**

SEGMENT CODE: **ELE**

PART NUMBER: **67101**

Coverings	
Id	Assembly
[12]	

Notes	
①	Lock Tape Loom with Tesa 51036

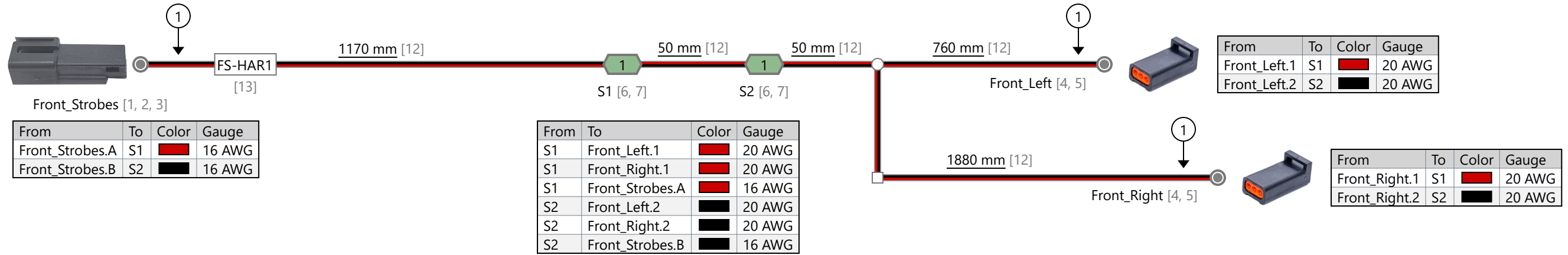

Revisions			
Rev.	Date	Author	Description
A	11/5/2021	Bennet Fisher	Initial Drawing

UNLESS OTHERWISE SPECIFIED DIMENSIONS ARE IN MILLIMETERS (INCHES) TOLERANCES: ±5MM		Name	Date
Designed By		Bennet Fisher	11/5/2021
Engineering Approval		----	----
Manufacturing Approval		----	----
Revision Approval		----	----
Quality Assurance		----	----
PROPRIETARY AND CONFIDENTIAL THE INFORMATION CONTAINED IN THIS DRAWING IS THE SOLE PROPERTY OF AAMP GLOBAL. ANY REPRODUCTION IN PART OR AS A WHOLE WITHOUT THE WRITTEN PERMISSION OF AAMP GLOBAL IS PROHIBITED.			



— ADVANCING VEHICLE TECHNOLOGY —

Part Number: FS-HAR1	Revision: ----
Description: Front Strobe Harness	Sheet: 1 of 1

PURCHASED COMPONENT KEY FEATURES

DESCRIPTION OF REQUIREMENTS

DIMENSIONAL REQUIREMENTS (AS SHOWN ON DRAWING)

N/A

LOAD/RATING REQUIREMENT

N/A

MATERIAL REQUIREMENT

N/A

PACKAGING REQUIREMENT

N/A

OTHER REQUIREMENTS



THIS DRAWING IS THE PROPERTY OF ADRIAN STEEL COMPANY AND IS NOT TO BE USED IN ANY MANNER DETRIMENTAL TO THE INTERESTS OF ADRIAN STEEL COMPANY

TOLERANCES & INSPECTION

UNLESS OTHERWISE SPECIFIED

ALL BEND ANGLES ARE 90 DEGREES

ALL DIMENSIONS ARE IN INCHES.

REFERENCE DIMENSIONS (X.XXX)
DO NOT REQUIRE INSPECTION

FEATURES	HOLES/SLOTS	ANGLES
0.0 = ± .125	0.0 = ± .062	0° = ± 2°
0.00 = ± .062	0.00 = ± .031	0.0° = ± 1°
0.000 = ± .031	0.000 = ± .015	

Material Thickness: per ASTM Std.
Weld Callouts per AWS

RELEASE & REVISIONS

INITIAL ECN: **25378**

CURRENT ECN: **25378**

ECN DESCRIPTION:

RELEASE FOR PRODUCTION

REVISED BY:

PURCHASED COMPONENT

REFERENCED SUPPLIER AND/OR MANUFACTURER

AAMP GLOBAL

REFERENCED SUPPLIER AND/OR MANUFACTURER PART NUMBER

RS-HAR3 OR 67108

COLOR (ONLY LIST IF COLOR SPECIFIC)

COMODITY ITEM (Y/N) (YES = ALL DIMENSIONS AND NOTES ARE REFERENCE)
(NOTE: DIMENSIONS AND FEATURES MAY VARY FOR A COMODITY ITEM.)

NO

PRINTED DOCUMENT IS UNCONTROLLED

Sheet 1 of 1

PART / PRODUCT IDENTIFICATION



ADRIAN STEEL®

ADRIAN STEEL COMPANY
906 JAMES STREET, ADRIAN, MI 49221

REVISION LEVEL

A

MAT'L USED: **PURCHASED**

DESIGNED BY: **E.BURKE**

DESCRIPTION: **REAR STROBE HARNESS 3**

WEIGHT (Lbs.): **0.2**

SEGMENT CODE: **ELE**

PART NUMBER: **67108**

Coverings	
Id	Assembly
[12]	

Notes	
①	Lock Tape Loom with Tesa 51036

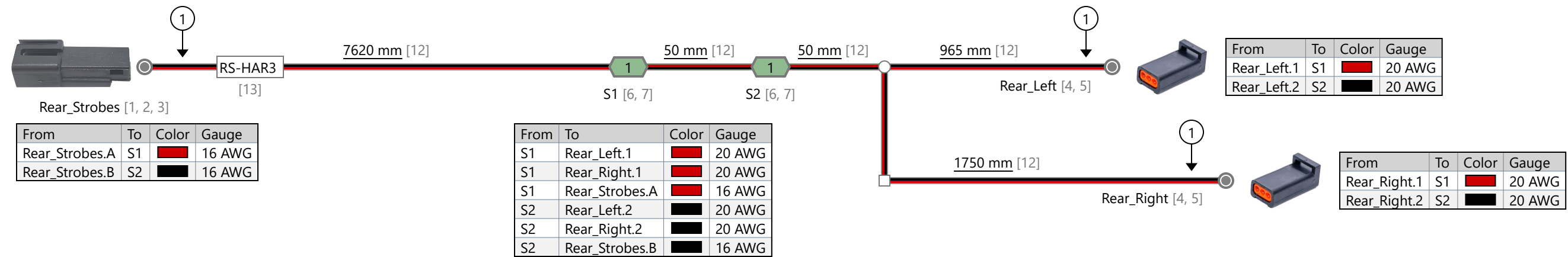

From	To	Color	Gauge
Rear_Strokes.A	S1	Red	16 AWG
Rear_Strokes.B	S2	Black	16 AWG

From	To	Color	Gauge
S1	Rear_Left.1	Red	20 AWG
S1	Rear_Right.1	Red	20 AWG
S1	Rear_Strokes.A	Red	16 AWG
S2	Rear_Left.2	Black	20 AWG
S2	Rear_Right.2	Black	20 AWG
S2	Rear_Strokes.B	Black	16 AWG

From	To	Color	Gauge
Rear_Left.1	S1	Red	20 AWG
Rear_Left.2	S2	Black	20 AWG

From	To	Color	Gauge
Rear_Right.1	S1	Red	20 AWG
Rear_Right.2	S2	Black	20 AWG

Revisions			
Rev.	Date	Author	Description
A	11/5/2021	Bennet Fisher	Initial Drawing

UNLESS OTHERWISE SPECIFIED DIMENSIONS ARE IN MILLIMETERS (INCHES) TOLERANCES: ±5MM		Name	Date
DESIGNED BY		Bennet Fisher	11/5/2021
ENGINEERING APPROVAL		----	----
MANUFACTURING APPROVAL		----	----
REVISION APPROVAL		----	----
QUALITY ASSURANCE		----	----



Part Number: RS-HAR3	Revision: ----
Description: Rear Strobe Harness	Sheet: 1 of 1

PROPRIETARY AND CONFIDENTIAL

THE INFORMATION CONTAINED IN THIS DRAWING IS THE SOLE PROPERTY OF AAMP GLOBAL. ANY REPRODUCTION IN PART OR AS A WHOLE WITHOUT THE WRITTEN PERMISSION OF AAMP GLOBAL IS PROHIBITED.

PURCHASED COMPONENT KEY FEATURES

DESCRIPTION OF REQUIREMENTS

DIMENSIONAL REQUIREMENTS (AS SHOWN ON DRAWING)

N/A

LOAD/RATING REQUIREMENT

N/A

MATERIAL REQUIREMENT

N/A

PACKAGING REQUIREMENT

N/A

OTHER REQUIREMENTS

**ECCO STROBE LIGHT: ED3801
WITH EXTERIOR PLUG AND PLAY CONNECTOR**



THIS DRAWING IS THE PROPERTY OF ADRIAN STEEL COMPANY AND IS NOT TO BE USED IN ANY MANNER DETRIMENTAL TO THE INTERESTS OF ADRIAN STEEL COMPANY

TOLERANCES & INSPECTION

UNLESS OTHERWISE SPECIFIED

ALL BEND ANGLES ARE 90 DEGREES

ALL DIMENSIONS ARE IN INCHES.

REFERENCE DIMENSIONS (X.XXX)
DO NOT REQUIRE INSPECTION

FEATURES	HOLES/SLOTS	ANGLES
0.0 = ± .125	0.0 = ± .062	0° = ± 2°
0.00 = ± .062	0.00 = ± .031	0.0° = ± 1°
0.000 = ± .031	0.000 = ± .015	

Material Thickness: per ASTM Std.
Weld Callouts per AWS

RELEASE & REVISIONS

INITIAL ECN: **25921**

CURRENT ECN: **25921**

ECN DESCRIPTION:

RELEASE TO PRODUCTION

REVISED BY: **N/A**

PURCHASED COMPONENT

REFERENCED SUPPLIER AND/OR MANUFACTURER

ECCO

REFERENCED SUPPLIER AND/OR MANUFACTURER PART NUMBER

ED3801A-ADR

COLOR (ONLY LIST IF COLOR SPECIFIC)

AMBER LED/CLEAR LENS

COMODITY ITEM (Y/N) (YES = ALL DIMENSIONS AND NOTES ARE REFERENCE)
(NOTE: DIMENSIONS AND FEATURES MAY VARY FOR A COMODITY ITEM.)

NO

PRINTED DOCUMENT IS UNCONTROLLED

Sheet 1 of 1

PART / PRODUCT IDENTIFICATION



ADRIAN STEEL®

ADRIAN STEEL COMPANY
906 JAMES STREET, ADRIAN, MI 49221

REVISION LEVEL

A

MAT'L USED: **PURCHASED**

DESIGNED BY: **EMB**

DESCRIPTION: **ECCO STROBE ED3801A W/CON**

WEIGHT (Lbs.): **0.5**

SEGMENT CODE: **EST**

PART NUMBER: **67686**