

Plug & Play Three LED Light Strips Kit

CATALOG NUMBER

69647



LED Light Strips Installed on Roof Bows

PRODUCT FEATURES

Plug & Play Three Strip Lights Kit w/ Switches - Low Roof

- Included in this kit is three (3) 36" LED light strips, roof bow harnesses #2, #3, & #4, power harness, and voltage timer module.
- This kit is ideal for the RAM ProMaster.
- There are no OEM options that this product requires. OEM options LCP, LDB, and 22G are not compatible with this kit.
- This kit is designed to provide LED lighting to the cargo area of the vehicle and can be controlled by switches.

Model Year Validated:

2022

Introduction / Comments:

Install Instructions For Interior Plug & Play Lights For Promaster

Note:

Read all instructions prior to installation. Review the Adrian Steel **GENERAL PRECAUTIONS PAGES (56638)** before attempting installation. Only personnel familiar with using electrical best practices should perform this install. Reference **ELECTRICAL BEST PRACTICES MANUAL (54479)** before attempting installation.



Installation Instructions For Interior Plug And Play Lights For Promaster

****Please read statement below before moving forward****

These plug and play kits are completely modular and can be configured in many different ways. Placement of lights will be determined by sales order drawings/customer ask. Therefore, these instructions are for the most standard configurations, and for reference only. The only harness that is specific to the transit vehicle are the power harnesses 65796. Routing will be very standard across all kits, but placement of lights and switches are subject to be different from these instructions if called out on the order drawing differently.

Overall Harness Diagram

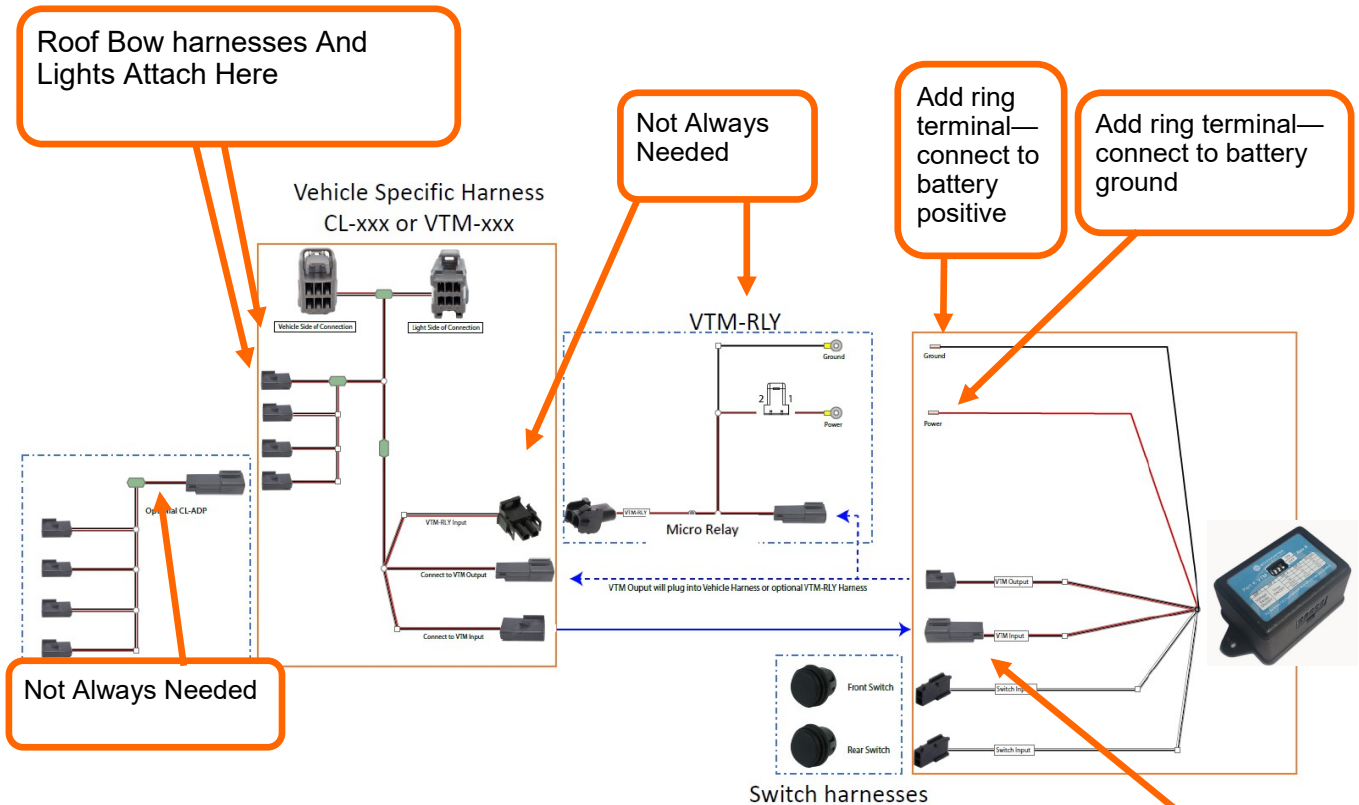

Tools required:

Crimpers



M8 Socket and/or wrench



Power drill, 3/8" step drill bit, Philips head bit (if installing dome lights)



For all vehicles that are NOT RAM. This connector will be black. **RAM vehicles, this will be white.** See page 4 for more details.

Specific Harness Diagram

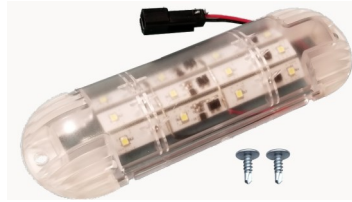

Roof Bow Harnesses and Lights Connect Here

Vehicle Specific Harness
CL-xxx or VTM-xxx

Insert into OEM Light Connector:
See Below

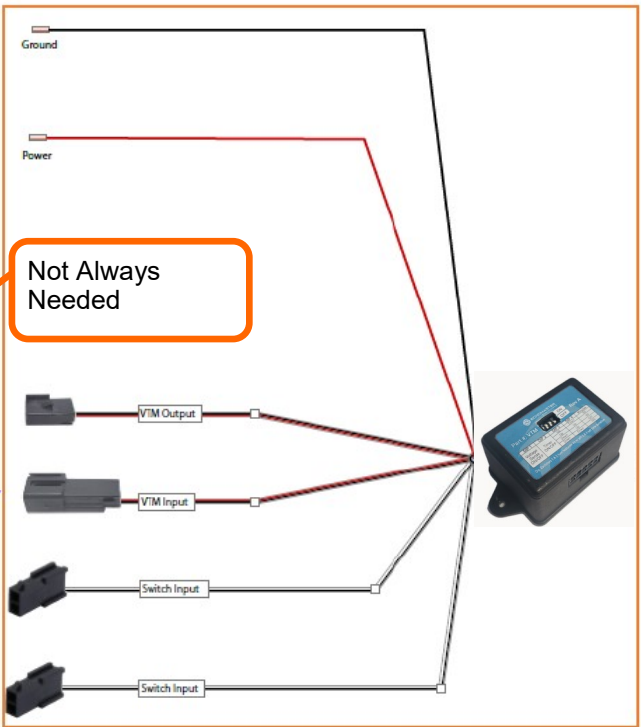
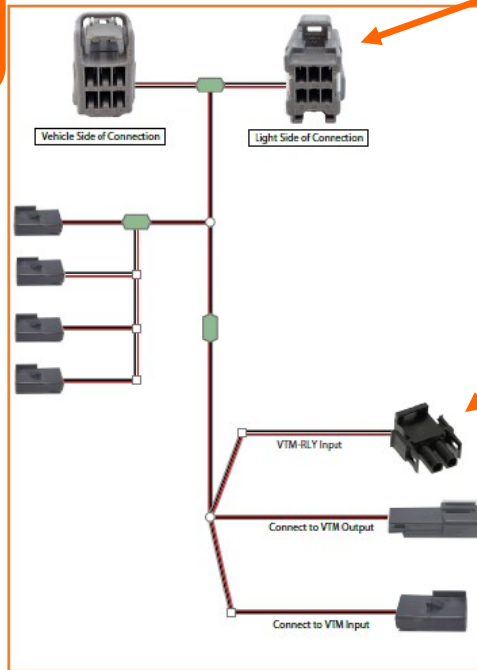

Not Always Needed



Switch Harness in between

OEM Light Connector located on the back of the OEM light: Remove the OEM light from the location

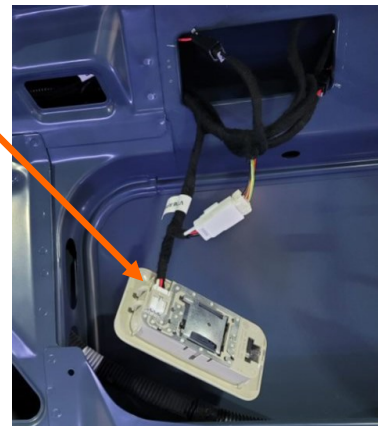
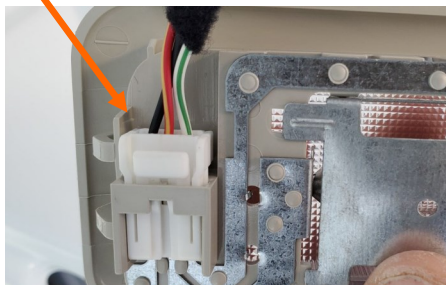

Voltage Timer Module (VTM) Harness Reference

For all vehicles except RAM, the black input connector will be used to plug into the vehicle specific harness. The white connector will NOT be used.

For all RAM vehicles, the white connector will be used to plug into the vehicle specific harness. The black connector will NOT be used.

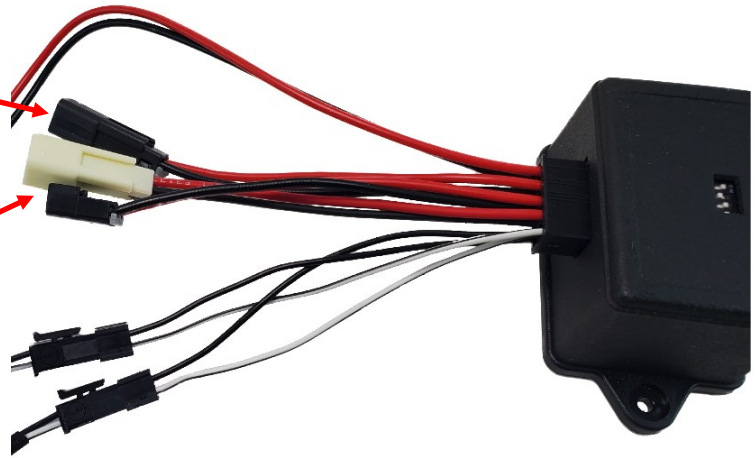

Harnesses Needed

	Part Number	Description
1	65786	Voltage Timer Module (VTM)
2	63480 Or/And 64222, 65346, 65347, 65348	Dome Light Or/And Strip Lights
3	63481 Or/And 63842, 63483, 63484	Roof Bow Harnesses 1 through 4
4	65796	Power Harness
5	65787 Or/And 65788, 65789, 65790	Switch Harness 1 through 4 for VTM



Harness pictures are for reference only.

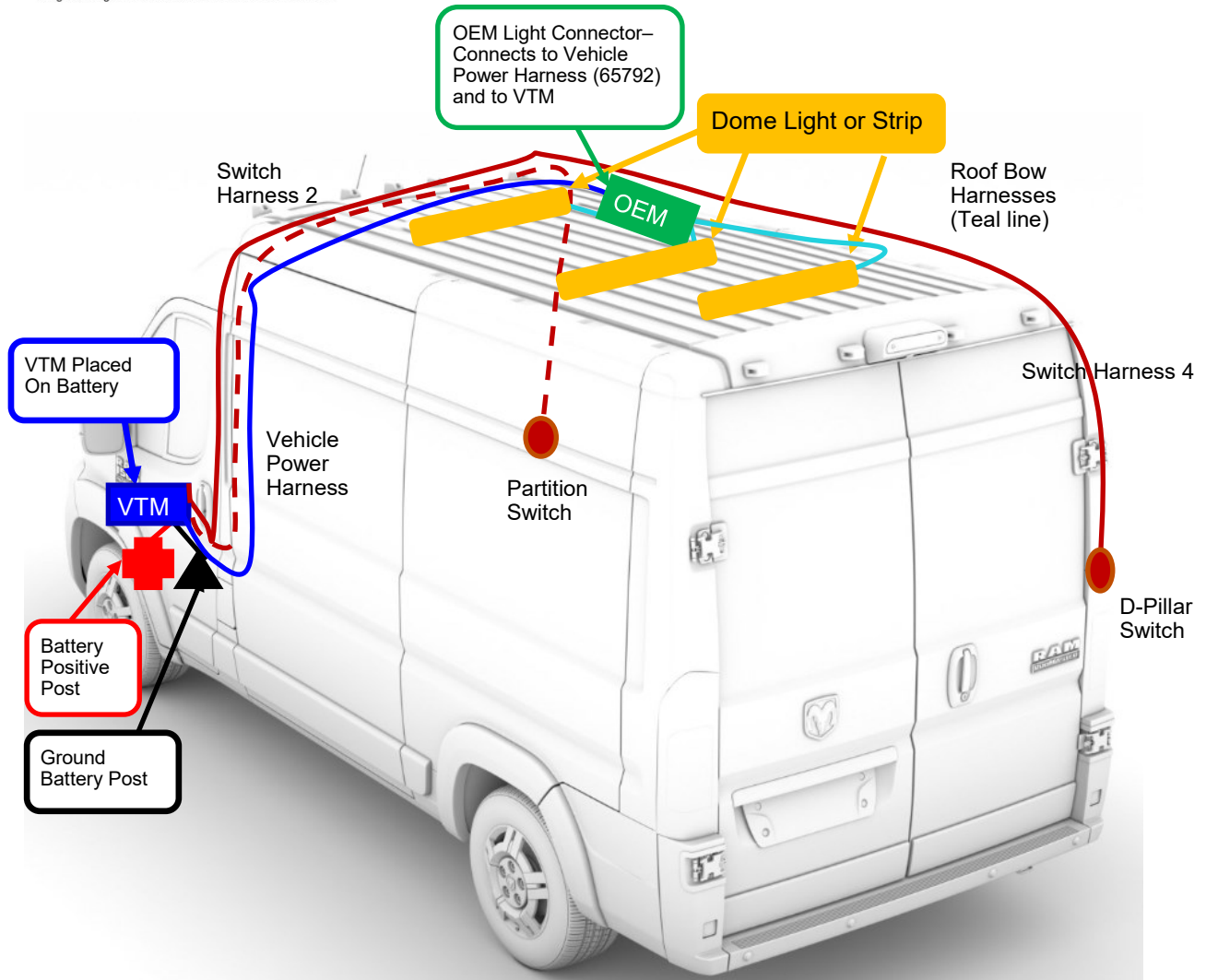

Color	Key - Items
Blue	VTM/Harness
Green	Vehicle Specific Power Harness
Black	Ground Location
Red	12V location
Redish/Brown	Switch Harnesses
Yellow	Dome or Strip Lights
Teal	Roof Bow Harnesses

The purpose of plug and play lighting is to be completely modular. Due to this feature, refer to the order drawing for all exact lighting placements. These installation instructions are for most cases and for reference.

Roof Bow Harnesses And Light Placements: Refer To Ordering Drawing For Light Placements



Vehicle	Roof Bow 1	Roof Bow 2	Roof Bow 3	Roof Bow 4	Roof Bow 5	Roof Bow 6
Promaster City	P-HARRB2	P-HARRB1	N/A	N/A	N/A	N/A
Promaster 1500 136" WB	P-HARRB3	P-HARRB1	P-HARRB2	N/A	N/A	N/A
Promaster 1500 136" WB (2022)	P-HARRB3 +	P-HARRB2	P-HARRB4	P-HARRB3		
Promaster 2500-3500 159" WB	P-HARRB2	P-HARRB1	P-HARRB1	P-HARRB1	P-HARRB3	P-HARRB3

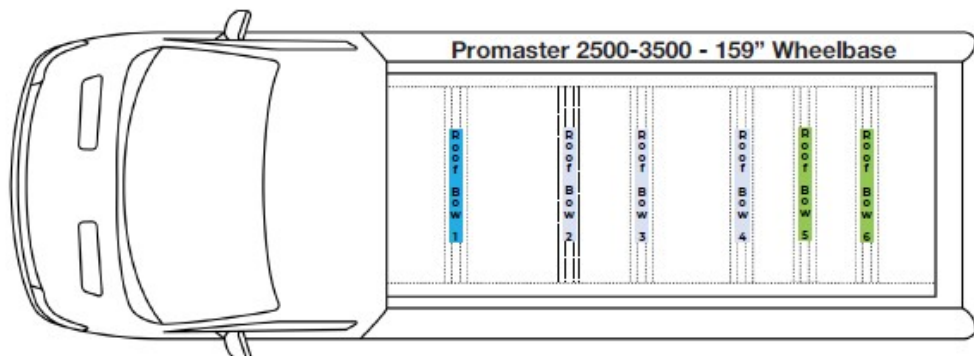
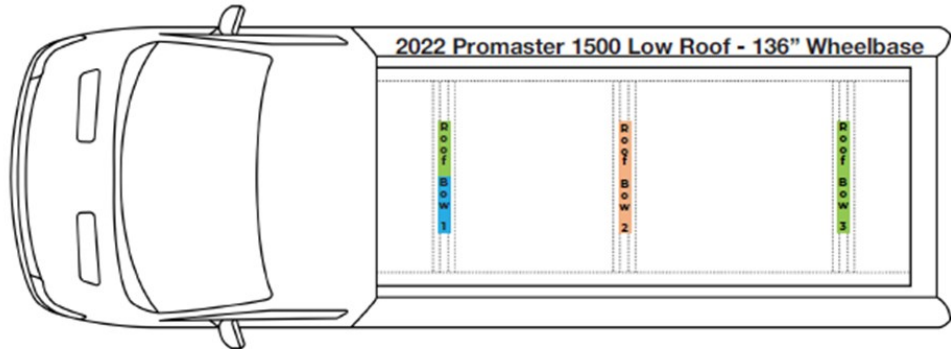
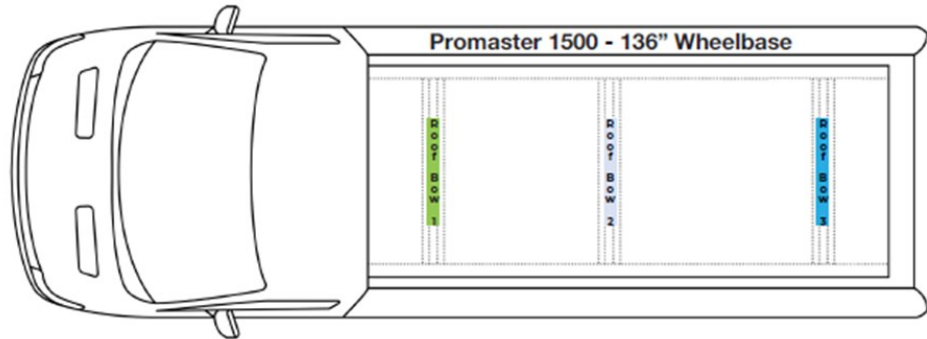
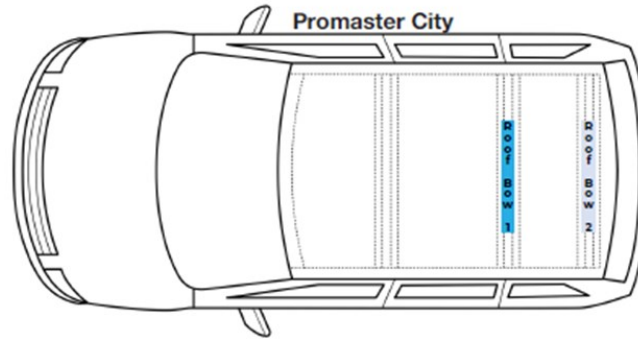

Optional Required Harnesses:

64244: This adapter harness allows for extra extensions to be added (if needed).



Be sure not to overload the OEM circuit by putting too many lights on the circuit. Consult ASCO Electrical Engineering team for application advice if using more than 4 lights.

Add Relay Harness 65791 for extra amperage. (Not always needed)

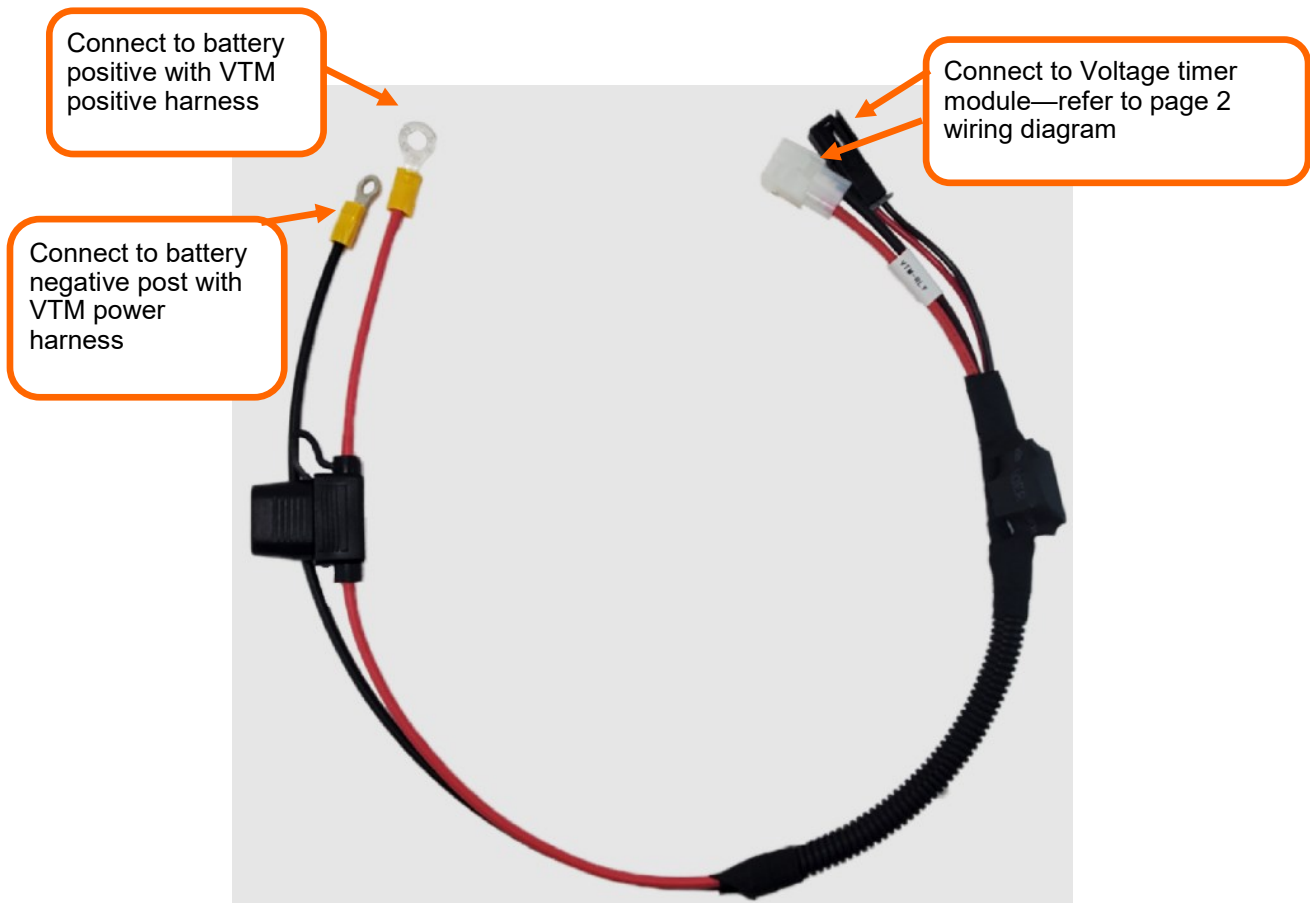

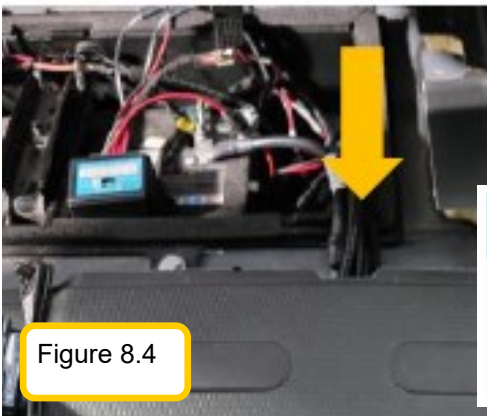
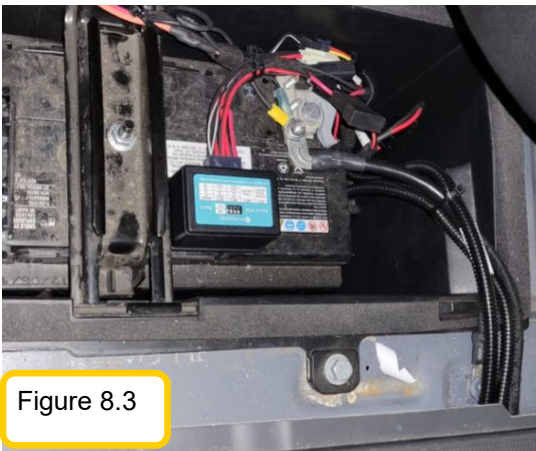
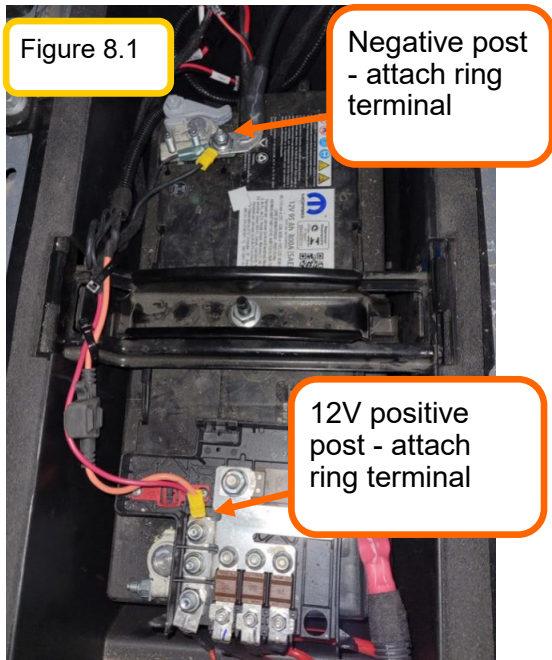

Step 1: Locate the VTM harness #65786

Attach the two 1/4" ring terminals to the red wire and the black wire.

Remove the fuse from the inline fuse holder until the end of the install.

Plug the harness connector into the voltage timer module port

Step 2: Locate the OEM battery under the foot well of the driver's seat.

Attach the positive (red) wire to the 12V positive post outlined in figure 8.1. Secure with the OEM nut.

Attach the ground ring terminal (black) to the negative post. Secure with the OEM nut. See Figure 8.1.

Step 3: *Please be sure to set all the dip switches on the VTM UP*****

Refer to the bottom picture for dip switch settings. If the customer would like a different amount of time other than 90 minutes, use the dip switches to set the time.

Apply the VHB tape to the back of the VTM (voltage timer module). See figure 8.2.

Stick the VTM to the top of the negative side of the battery and secure with zip ties. See figure 8.3.

Plug the switch harnesses (65788 & 65790) into the VTM harness. See pages 2 & 3 for reference.

Route the harness bundle under the floor mat like shown in figure 8.4. Continue routing the bundle between the seats, rearward to the B-pillar, then up and behind the partition. Reference page 5 for overall wiring.

VTM Dip Switch Settings

DIP SWITCH 1 UP/DOWN	DIP SWITCH 2 UP/DOWN	DIP SWITCH 3	DIP SWITCH 4	Timer Duration (Minutes)
Voltage Sense ON/OFF	Timer ON/OFF	UP	DOWN	60
		UP	UP	90
		DOWN	UP	120
		DOWN	DOWN	150



Step 4: For High roof vehicles:

Locate the OEM cargo light on the passenger side of the roof. Figure 9.1.

For Low Roof Vehicles:

Locate the rear OEM cargo light above the back doors. Figure 9.2.

Carefully remove the OEM light with a trim tool. Figure 9.3.



Unplug the OEM connector from the back of the light. Figure 9.4.

Plug the vehicle specific power harness (65796) into the OEM connector:

You no longer need the OEM light. You can dispose of it how you would like.



Route the power harness down the partition to the VTM module, and plug it in. Be sure to use the white colored VTM input connector referenced on page 4. The black connector will NOT be used for this install.

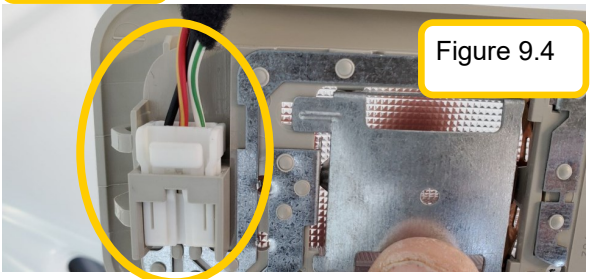

Step 5:

Connect the roof bow harnesses (63481 Or/ And 63842, 63483, 63484 all that are applicable) to the power harness and route them to their desired light locations. (Light locations on the roof bows). Figure 9.6.

Refer to page 6 for which harnesses to use for the roof bows.

Use zip ties/fir trees to secure all wiring.



Figure 10.1



Step 6:

Before mounting any lights, prep the surface where the light will be placed with the supplied alcohol pad. Let dry for a few minutes, then mount the light.

Be sure the surface is clean before applying the VHB tape. Read the supplied instructions in the lighting boxes.

Mount the strip/dome lights to their desired locations: Refer to the order drawing.

Figure 10.2

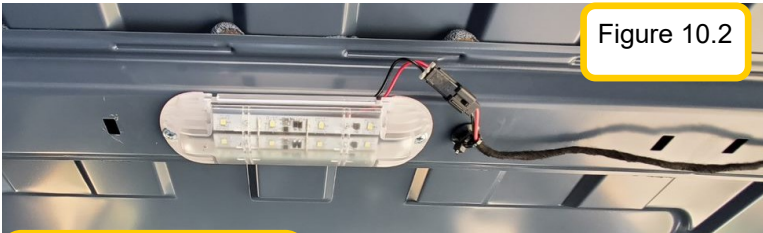

For dome lights, use the VHB tape already on the back of the light, and also secure with the supplied tek screws.

Dome lights are to be placed as close to the center of the roof bow as possible. Figure 10.1 and 10.2.

Figure 10.3
Transit Reference

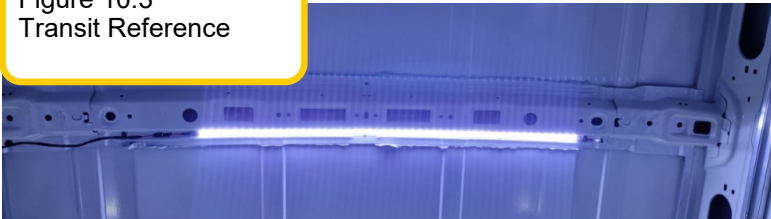

For the strip lights, use the VHB tape supplied on the back of the lights, and use the little square sticky backs with zip ties that are supplied in the box.

Figure 10.4
GM Express
Reference



Strip lights are to be placed as close to the center as possible of the roof bows. See reference pictures of the Chevy Express and Transit vans below. Use best judgement for the strip light placements, just be sure to do the same for all the needed roof bows. Figure 10.3 and 10.4 for references.

Figure 10.5

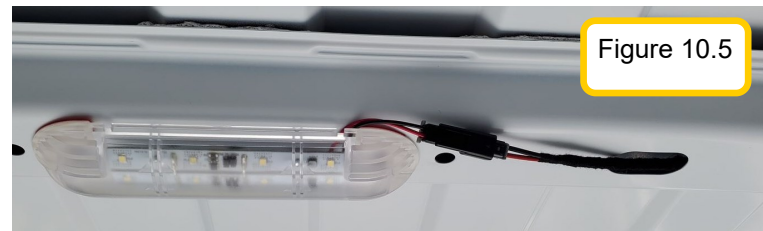

Route the roof bow harnesses to the lights and connect them. When applicable route the harness inside the roof channel. When not, use zip ties and fire trees to secure the wiring. Figures 10.5 and 10.6.

Figure 10.6

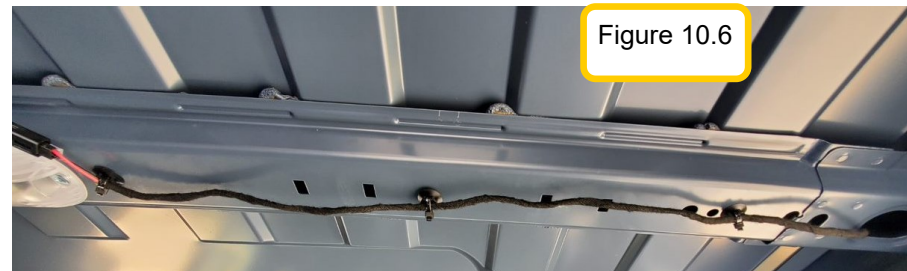

Figure 11.1



Partition Switch

Locations:

Switch hole in steel partition behind the passenger's seat (figure 11.1) or drill out switch hole in composite partition (figure 11.2).

This location will require harness #65788

Rear Switch Location:

Passenger side rear D-pillar.

Drill out the circle divot on the rear D-pillar trim panel. Reference figure 11.3.

This location will require harness #65790

Figure 11.2



Step 7:

Route the 65788 harness from the VTM harness location to the partition switch location.

Do the same with harness 65790 to the D-pillar switch location.

Use Zip ties to secure wiring.

Drill needed holes for the switches in rear D pillar panel, and composite partition (if applicable).

Figure 11.3



Insert the switches into the holes with the "1" in the 12:00 position, connect the harness (the connection orientation does not matter).

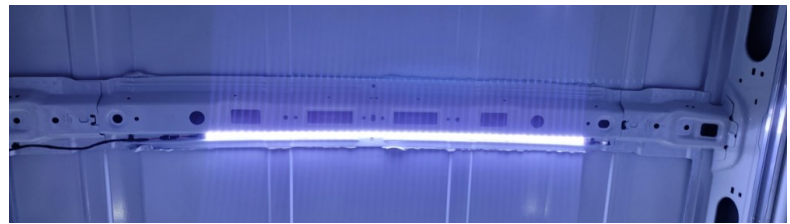

Insert the fuse into the inline-fuse holder on the power harness. The install is now complete. Secure all wiring with zip ties. Re-attach all trim. Double check the functionality of the lights and switches.

PART NUMBER

13905-0

ITEM DESCRIPTION: WIRE TIE, NYLON 40Lb, 8.5" BLACK



MANUFACTURER: WAYTEK, INC. or equivalent
MANUFACTURERS PART NUMBER: 21093M or 21093C

SPECIFICATIONS: STANDARD CABLE TIE
 BLACK, NYLON
 8-1/2" LONG
 TENSILE STRENGTH: 40.0 LBS
 21093M = 1,000 quantity
 21093C = 100 quantity

SPECIAL NOTES: PART NUMBER IS BLACK.

SUPPLIED BY: THIS ITEM IS ADRIAN AVAILABLE!

PURCHASED PRODUCT DATA SHEET (PPDS)

THIS DRAWING/INFORMATION IS THE PROPERTY OF ADRIAN STEEL COMPANY AND IS NOT TO BE USED IN ANY MANNER THAT IS DETRIMENTAL TO THE INTEREST OF ADRIAN STEEL. COPYRIGHTS AND OR PATENTS THAT MAY BE THE PROPERTY OF APPLICABLE OWNERS MAY PROTECT INFORMATION AND/OR DRAWINGS OF SUPPLIED PRODUCTS.



ADRIAN STEEL
VAN AND PICKUP EQUIPMENT

906 JAMES STREET
ADRIAN, MI 49221
517-265-6194
WWW.ADRIANSTEEL.COM



WHEN INSTALLING EQUIPMENT IN OR ON VEHICLES CHECK FOR FUEL TANKS, FUEL LINES, CONTROL LINES AND ELECTRICAL WIRING BEFORE DRILLING! ALWAYS USE DRILL BITS WITH INTEGRAL STOPS WHENEVER POSSIBLE!

DRAWN BY
MDG

DATE DRAWN
10/26/2006

ECN NUMBER
18021

ECN DATE
11/13/2015

PART WEIGHT
0.01 LBS.

REV. LEVEL
D

PART NUMBER
13905-0

PURCHASED COMPONENT KEY FEATURES

DESCRIPTION OF REQUIREMENTS

DIMENSIONAL REQUIREMENTS (AS SHOWN ON DRAWING)

Base is a 0.975 inch square

LOAD/RATING REQUIREMENT

N/A

MATERIAL REQUIREMENT

N/A

PACKAGING REQUIREMENT

N/A

OTHER REQUIREMENTS

Black adhesive wire tie mounting base.

Cure Time: Bond 15 Min., Max
Adhesion 1 Hr.

Max. Operating 158

Temp. F:

Max. Operating 70

Temp. C:

Min. Installation 65

Temp. F:

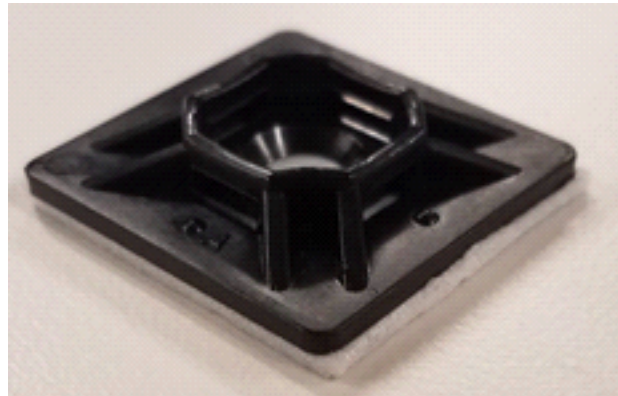

THIS DRAWING IS THE PROPERTY OF ADRIAN STEEL COMPANY AND IS NOT TO BE USED IN ANY MANNER DETRIMENTAL TO THE INTERESTS OF ADRIAN STEEL COMPANY

TOLERANCES & INSPECTION

UNLESS OTHERWISE SPECIFIED

ALL BEND ANGLES ARE 90 DEGREES

ALL DIMENSIONS ARE IN INCHES.

REFERENCE DIMENSIONS (X.XXX)

DO NOT REQUIRE INSPECTION

FEATURES	HOLES/SLOTS	ANGLES
0.0 = ± .125	0.0 = ± .062	0° = ± 2°
0.00 = ± .062	0.00 = ± .031	0.0° = ± 1°
0.000 = ± .031	0.000 = ± .015	

Material Thickness: per ASTM Std.
Weld Callouts per AWS

RELEASE & REVISIONS

INITIAL ECN: 17429

CURRENT ECN: 22185

ECN DESCRIPTION:

Size of the base changed with a change in supplier

REVISED BY: D. LaCroix

PURCHASED COMPONENT

REFERENCED SUPPLIER AND/OR MANUFACTURER

Midstate

REFERENCED SUPPLIER AND/OR MANUFACTURER PART NUMBER

49401

COLOR (ONLY LIST IF COLOR SPECIFIC)

COMODITY ITEM (Y/N) (YES = ALL DIMENSIONS AND NOTES ARE REFERENCE)
(NOTE: DIMENSIONS AND FEATURES MAY VARY FOR A COMODITY ITEM.)

YES

PRINTED DOCUMENT IS UNCONTROLLED

Sheet 1 of 1

PART / PRODUCT IDENTIFICATION



ADRIAN STEEL

ADRIAN STEEL COMPANY
906 JAMES STREET, ADRIAN, MI 49221

REVISION LEVEL

B

MAT'L USED:

DESIGNED BY: **RJB**

DESCRIPTION:

Adhesive wire tie base

WEIGHT (Lbs.):

0.05

SEGMENT CODE:

HDW

PART NUMBER: **49401**

PURCHASED COMPONENT KEY FEATURES

DESCRIPTION OF REQUIREMENTS

DIMENSIONAL REQUIREMENTS (AS SHOWN ON DRAWING)

N/A

LOAD/RATING REQUIREMENT

N/A

MATERIAL REQUIREMENT

N/A

PACKAGING REQUIREMENT

N/A

OTHER REQUIREMENTS

- **Roof Bow #2**
- **(5x) WIRE TIE W/CHRISTMAS TREE**
- **1570mm Length**



P-HARRB2

(5x)

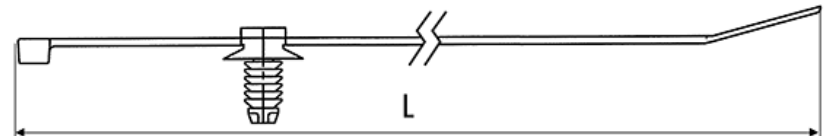
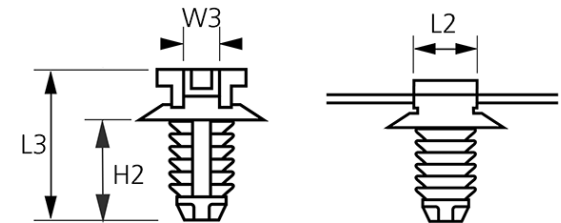

THIS DRAWING IS THE PROPERTY OF ADRIAN STEEL COMPANY AND IS NOT TO BE USED IN ANY MANNER DETRIMENTAL TO THE INTERESTS OF ADRIAN STEEL COMPANY

PRINTED DOCUMENT IS UNCONTROLLED

Sheet 1 of 1

TOLERANCES & INSPECTION

UNLESS OTHERWISE SPECIFIED
 ALL BEND ANGLES ARE 90 DEGREES
 ALL DIMENSIONS ARE IN INCHES.
 REFERENCE DIMENSIONS (X.XXX)
 DO NOT REQUIRE INSPECTION

FEATURES	HOLES/SLOTS	ANGLES
0.0 = ± .125	0.0 = ± .062	0° = ± 2°
0.00 = ± .062	0.00 = ± .031	0.0° = ± 1°
0.000 = ± .031	0.000 = ± .015	

Material Thickness: per ASTM Std.
 Weld Callouts per AWS

RELEASE & REVISIONS

INITIAL ECN:	24359
CURRENT ECN:	24359
ECN DESCRIPTION:	QE8539 RELEASE MODULAR DOME LIGHTING
REVISED BY:	MJF

PURCHASED COMPONENT

REFERENCED SUPPLIER AND/OR MANUFACTURER
ECHOMASTER FLEET SOLUTIONS
 REFERENCED SUPPLIER AND/OR MANUFACTURER PART NUMBER
P-HARRB2
 COLOR (ONLY LIST IF COLOR SPECIFIC)

COMODITY ITEM (Y/N) (YES = ALL DIMENSIONS AND NOTES ARE REFERENCE)
 (NOTE: DIMENSIONS AND FEATURES MAY VARY FOR A COMODITY ITEM.)
YES

PART / PRODUCT IDENTIFICATION

ADRIAN STEEL ADRIAN STEEL COMPANY 906 JAMES STREET, ADRIAN, MI 49221		REVISION LEVEL A	
MAT'L USED:	PURCHASED	DESIGNED BY:	MJF
DESCRIPTION:	ROOF BOW HARNESS #2		
WEIGHT (Lbs.):	.50	SEGMENT CODE:	EAU
		PART NUMBER:	63482

PURCHASED COMPONENT KEY FEATURES

DESCRIPTION OF REQUIREMENTS

DIMENSIONAL REQUIREMENTS (AS SHOWN ON DRAWING)

N/A

LOAD/RATING REQUIREMENT

N/A

MATERIAL REQUIREMENT

N/A

PACKAGING REQUIREMENT

N/A

OTHER REQUIREMENTS

- **Roof Bow #3**
- **(5x) WIRE TIE W/CHRISTMAS TREE**
- **2570mm Length**



P-HARRB3

(5x)

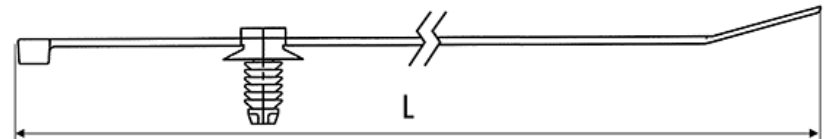
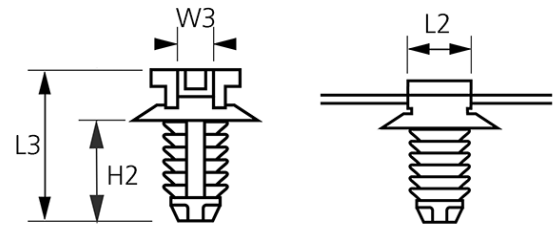
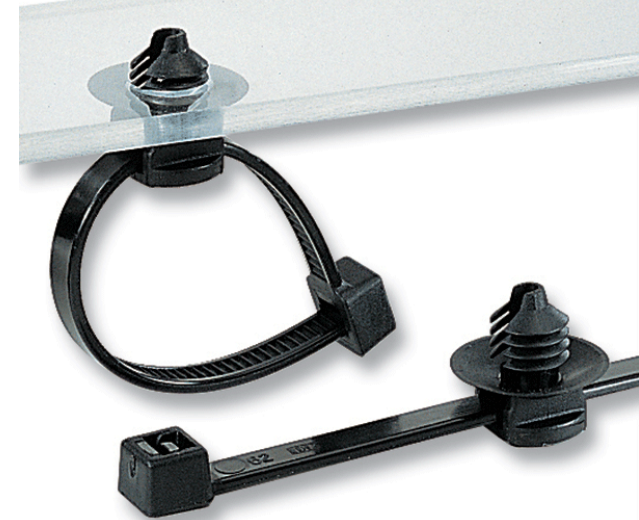

THIS DRAWING IS THE PROPERTY OF ADRIAN STEEL COMPANY AND IS NOT TO BE USED IN ANY MANNER DETRIMENTAL TO THE INTERESTS OF ADRIAN STEEL COMPANY

PRINTED DOCUMENT IS UNCONTROLLED

Sheet 1 of 1

TOLERANCES & INSPECTION

UNLESS OTHERWISE SPECIFIED

ALL BEND ANGLES ARE 90 DEGREES

ALL DIMENSIONS ARE IN INCHES.

REFERENCE DIMENSIONS (X.XXX)

DO NOT REQUIRE INSPECTION

FEATURES	HOLES/SLOTS	ANGLES
0.0 = ± .125	0.0 = ± .062	0° = ± 2°
0.00 = ± .062	0.00 = ± .031	0.0° = ± 1°
0.000 = ± .031	0.000 = ± .015	

Material Thickness: per ASTM Std.
Weld Callouts per AWS

RELEASE & REVISIONS

INITIAL ECN: 24359

CURRENT ECN: 24359

ECN DESCRIPTION:

QE8539 RELEASE MODULAR DOME LIGHTING

REVISED BY: MJF

PURCHASED COMPONENT

REFERENCED SUPPLIER AND/OR MANUFACTURER
ECHOMASTER FLEET SOLUTIONS

REFERENCED SUPPLIER AND/OR MANUFACTURER PART NUMBER
P-HARRB3

COLOR (ONLY LIST IF COLOR SPECIFIC)

COMODITY ITEM (Y/N) (YES = ALL DIMENSIONS AND NOTES ARE REFERENCE)
(NOTE: DIMENSIONS AND FEATURES MAY VARY FOR A COMODITY ITEM.)

YES

PART / PRODUCT IDENTIFICATION



ADRIAN STEEL

ADRIAN STEEL COMPANY
906 JAMES STREET, ADRIAN, MI 49221

REVISION LEVEL

A

MAT'L USED: **PURCHASED**

DESIGNED BY: **MJF**

DESCRIPTION: **ROOF BOW HARNESS #3**

WEIGHT (Lbs.):

.50

SEGMENT CODE: **EAU**

PART NUMBER: **63483**

PURCHASED COMPONENT KEY FEATURES

DESCRIPTION OF REQUIREMENTS

DIMENSIONAL REQUIREMENTS (AS SHOWN ON DRAWING)

N/A

LOAD/RATING REQUIREMENT

N/A

MATERIAL REQUIREMENT

N/A

PACKAGING REQUIREMENT

N/A

OTHER REQUIREMENTS

- **Roof Bow #4**
- **(5x) WIRE TIE W/CHRISTMAS TREE**
- **3470mm Length**



P-HARRB4

(5x)

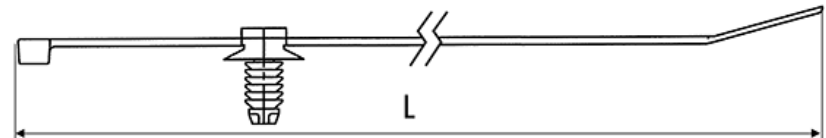
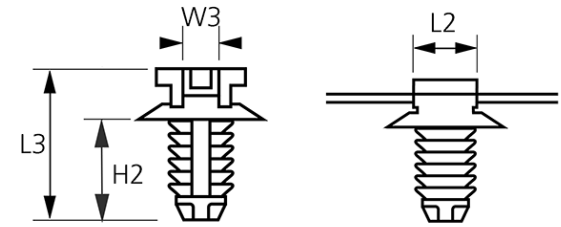

THIS DRAWING IS THE PROPERTY OF ADRIAN STEEL COMPANY AND IS NOT TO BE USED IN ANY MANNER DETRIMENTAL TO THE INTERESTS OF ADRIAN STEEL COMPANY

PRINTED DOCUMENT IS UNCONTROLLED

Sheet 1 of 1

TOLERANCES & INSPECTION

UNLESS OTHERWISE SPECIFIED

ALL BEND ANGLES ARE 90 DEGREES

ALL DIMENSIONS ARE IN INCHES.

REFERENCE DIMENSIONS (X.XXX)

DO NOT REQUIRE INSPECTION

FEATURES	HOLES/SLOTS	ANGLES
0.0 = ± .125	0.0 = ± .062	0° = ± 2°
0.00 = ± .062	0.00 = ± .031	0.0° = ± 1°
0.000 = ± .031	0.000 = ± .015	

Material Thickness: per ASTM Std.
Weld Callouts per AWS

RELEASE & REVISIONS

INITIAL ECN: 24359

CURRENT ECN: 24359

ECN DESCRIPTION:

QE8539 RELEASE MODULAR DOME LIGHTING

REVISED BY: MJF

PURCHASED COMPONENT

REFERENCED SUPPLIER AND/OR MANUFACTURER
ECHOMASTER FLEET SOLUTIONS

REFERENCED SUPPLIER AND/OR MANUFACTURER PART NUMBER

P-HARRB4

COLOR (ONLY LIST IF COLOR SPECIFIC)

COMODITY ITEM (Y/N) (YES = ALL DIMENSIONS AND NOTES ARE REFERENCE)
(NOTE: DIMENSIONS AND FEATURES MAY VARY FOR A COMODITY ITEM.)

YES

PART / PRODUCT IDENTIFICATION



ADRIAN STEEL

ADRIAN STEEL COMPANY
906 JAMES STREET, ADRIAN, MI 49221

REVISION LEVEL

A

MAT'L USED: **PURCHASED**

DESIGNED BY: **MJF**

DESCRIPTION:

ROOF BOW HARNESS #4

WEIGHT (Lbs.):

.50

SEGMENT CODE: **EAU**

PART NUMBER: **63484**

PURCHASED COMPONENT KEY FEATURES

DESCRIPTION OF REQUIREMENTS

DIMENSIONAL REQUIREMENTS (AS SHOWN ON DRAWING)

N/A

LOAD/RATING REQUIREMENT

N/A

MATERIAL REQUIREMENT

N/A

PACKAGING REQUIREMENT

N/A

OTHER REQUIREMENTS

Note:

Connector / Terminal Configuration:

- MALE 2 PIN ON ONE END
- FEMALE 2 PIN ON THE OPPOSITE END.

BOM:

Item	Qty.	Description
1	1	36" WHITE LED STRIP LIGHT W/ADHESIVE
2	2	4" ZIP TIE
3	2	CABLE TIE MOUNT
4	1	ALCOHOL PAD



THIS DRAWING IS THE PROPERTY OF ADRIAN STEEL COMPANY AND IS NOT TO BE USED IN ANY MANNER DETRIMENTAL TO THE INTERESTS OF ADRIAN STEEL COMPANY

TOLERANCES & INSPECTION

UNLESS OTHERWISE SPECIFIED

ALL BEND ANGLES ARE 90 DEGREES

ALL DIMENSIONS ARE IN INCHES.

REFERENCE DIMENSIONS (X.XXX)
DO NOT REQUIRE INSPECTION

FEATURES	HOLES/SLOTS	ANGLES
0.0 = ± .125	0.0 = ± .062	0° = ± 2°
0.00 = ± .062	0.00 = ± .031	0.0° = ± 1°
0.000 = ± .031	0.000 = ± .015	

Material Thickness: per ASTM Std.
Weld Callouts per AWS

RELEASE & REVISIONS

INITIAL ECN: **24697**

CURRENT ECN: **25778**

ECN DESCRIPTION:

Revise Modular Lights With New 3M Adhesive

REVISED BY: **JLT**

PURCHASED COMPONENT

REFERENCED SUPPLIER AND/OR MANUFACTURER

AAMP

REFERENCED SUPPLIER AND/OR MANUFACTURER PART NUMBER

CL-36BLED rev.B

COLOR (ONLY LIST IF COLOR SPECIFIC)

COMODITY ITEM (Y/N) (YES = ALL DIMENSIONS AND NOTES ARE REFERENCE)
(NOTE: DIMENSIONS AND FEATURES MAY VARY FOR A COMODITY ITEM.)

YES

PRINTED DOCUMENT IS UNCONTROLLED

Sheet 1 of 1

PART / PRODUCT IDENTIFICATION



ADRIAN STEEL®

ADRIAN STEEL COMPANY
906 JAMES STREET, ADRIAN, MI 49221

REVISION LEVEL

B

MAT'L USED:

DESIGNED BY: **J. TYNER**

DESCRIPTION:

MODULE DOME LED STRIP 36"

WEIGHT (Lbs.): **0.3**

SEGMENT CODE: **EAU**

PART NUMBER: **65347**

Notes

- ① 3:1 Adhesive Heat Shrink to be placed over LED Solder Joints
- ② 5925 Adhesive Liner Edges to be exposed next to heat shrink

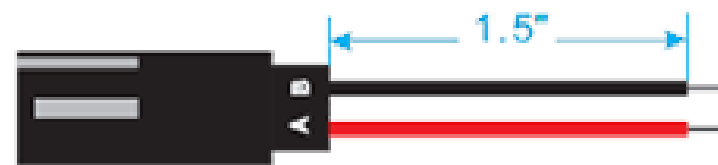
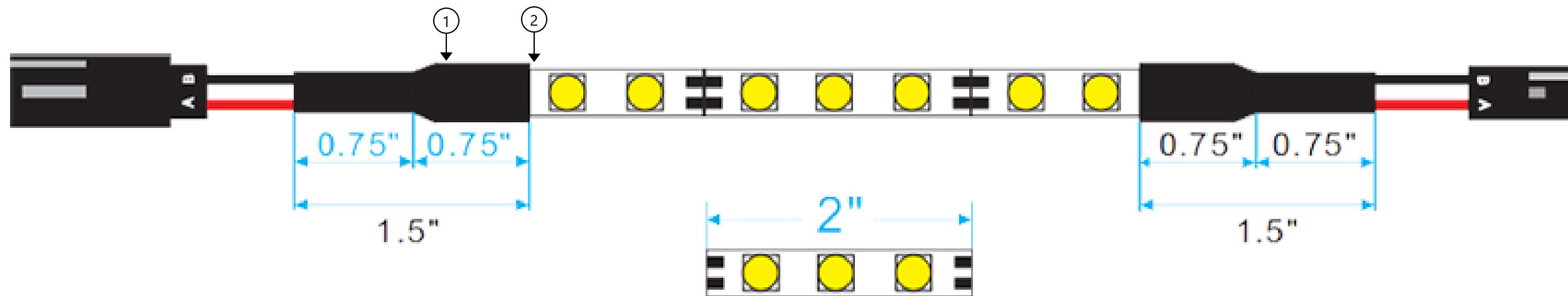

12"=6X
 24"=12X
 36"=18X
 48"=24X

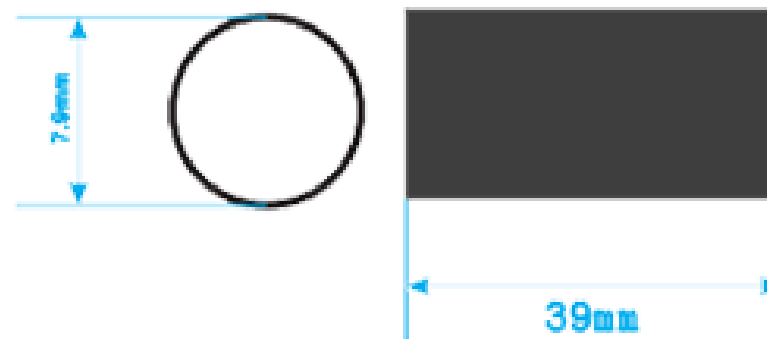

Revisions

Rev.	Date	Author	Description
A	11/1/21	Bennet Fisher	Initial Drawing
B	7/27/2022	Bennet Fisher	Adhesive changed to VHB 5925

UNLESS OTHERWISE SPECIFIED
 DIMENSIONS ARE IN MILLIMETERS [INCHES]
 TOLERANCES: ±5MM

PROPRIETARY AND CONFIDENTIAL

THE INFORMATION CONTAINED IN THIS
 DRAWING IS THE SOLE PROPERTY OF
 AAMP GLOBAL. ANY REPRODUCTION IN
 PART OR AS A WHOLE WITHOUT THE
 WRITTEN PERMISSION OF AAMP GLOBAL
 IS PROHIBITED.

	Name	Date
Designed By	Bennet Fisher	11/1/21
Engineering Approval		
Manufacturing Approval		
Revision Approval		
Quality Assurance		



Part Number: CL-36BLED	Revision: B
Description: 36" LED Strip	Sheet: 1

PURCHASED COMPONENT KEY FEATURES

DESCRIPTION OF REQUIREMENTS

DIMENSIONAL REQUIREMENTS (AS SHOWN ON DRAWING)

N/A

LOAD/RATING REQUIREMENT

N/A

MATERIAL REQUIREMENT

N/A

PACKAGING REQUIREMENT

N/A

OTHER REQUIREMENTS

INCLUDES HARNESS - "P-VTM-HAR"



THIS DRAWING IS THE PROPERTY OF ADRIAN STEEL COMPANY AND IS NOT TO BE USED IN ANY MANNER DETRIMENTAL TO THE INTERESTS OF ADRIAN STEEL COMPANY

TOLERANCES & INSPECTION

UNLESS OTHERWISE SPECIFIED

ALL BEND ANGLES ARE 90 DEGREES

ALL DIMENSIONS ARE IN INCHES.

REFERENCE DIMENSIONS (X.XXX)
DO NOT REQUIRE INSPECTION

FEATURES	HOLES/SLOTS	ANGLES
0.0 = ± .125	0.0 = ± .062	0° = ± 2°
0.00 = ± .062	0.00 = ± .031	0.0° = ± 1°
0.000 = ± .031	0.000 = ± .015	

Material Thickness: per ASTM Std.
Weld Callouts per AWS

RELEASE & REVISIONS

INITIAL ECN: **25377**

CURRENT ECN: **25377**

ECN DESCRIPTION:

RELEASE FOR PRODUCTION

REVISED BY:

PURCHASED COMPONENT

REFERENCED SUPPLIER AND/OR MANUFACTURER

AAMP GLOBAL

REFERENCED SUPPLIER AND/OR MANUFACTURER PART NUMBER

VTM OR 65786

COLOR (ONLY LIST IF COLOR SPECIFIC)

COMODITY ITEM (Y/N) (YES = ALL DIMENSIONS AND NOTES ARE REFERENCE)
(NOTE: DIMENSIONS AND FEATURES MAY VARY FOR A COMODITY ITEM.)

NO

PRINTED DOCUMENT IS UNCONTROLLED

Sheet 1 of 1

PART / PRODUCT IDENTIFICATION



ADRIAN STEEL®

ADRIAN STEEL COMPANY
906 JAMES STREET, ADRIAN, MI 49221

REVISION LEVEL

A

MAT'L USED: **PURCHASED**

DESIGNED BY: **E.BURKE**

DESCRIPTION: **VOLTAGE TIMER MODULE**

WEIGHT (Lbs.): **0.2**

SEGMENT CODE: **ELE**

PART NUMBER: **65786**

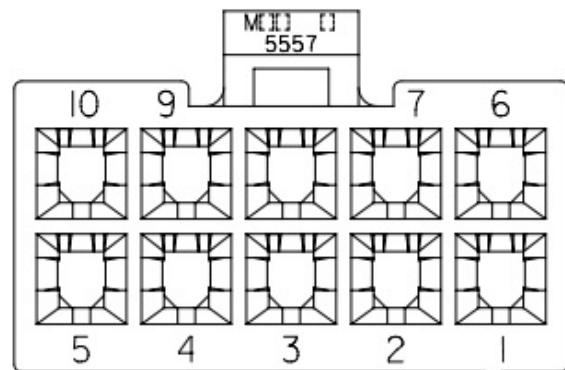

Rear View of Connector - Wire Side of Connector

From	To	Color	Gauge
C1.1	Fuse_Holder.1	Red	16 AWG
C1.2	Input1.A	Red	16 AWG
C1.3	Output.A	Red	16 AWG
C1.4	Input2.A	Red	16 AWG
C1.5	SW1_Input.1	White/Black	20 AWG
C1.5	SW2_Input.1	White/Black	20 AWG
C1.6	GND	Black	16 AWG
C1.7	Input1.B	Black	16 AWG
C1.8	Output.B	Black	16 AWG
C1.9	Input2.B	Black	16 AWG
C1.10	SW1_Input.2	Black	20 AWG
C1.10	SW2_Input.2	Black	20 AWG

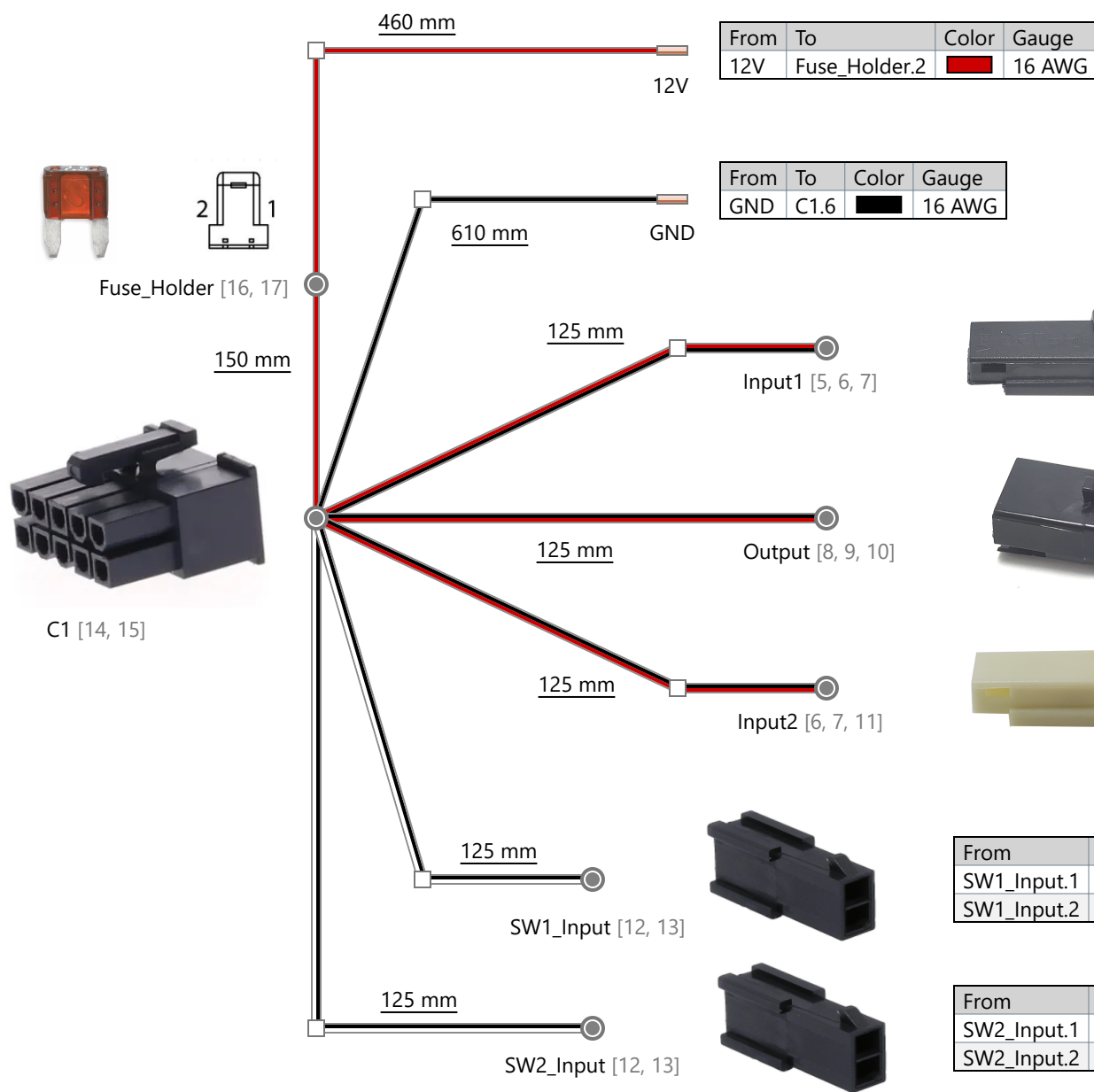

From	To	Color	Gauge
12V	Fuse_Holder.2	Red	16 AWG

From	To	Color	Gauge
GND	C1.6	Black	16 AWG

From	To	Color	Gauge
Input1.A	C1.2	Red	16 AWG
Input1.B	C1.7	Black	16 AWG

From	To	Color	Gauge
Output.A	C1.3	Red	16 AWG
Output.B	C1.8	Black	16 AWG

From	To	Color	Gauge
Input2.A	C1.4	Red	16 AWG
Input2.B	C1.9	Black	16 AWG

From	To	Color	Gauge
SW1_Input.1	C1.5	White/Black	20 AWG
SW1_Input.2	C1.10	Black	20 AWG

From	To	Color	Gauge
SW2_Input.1	C1.5	White/Black	20 AWG
SW2_Input.2	C1.10	Black	20 AWG

Input.1 for each switch is the ground signal that will be fed back to the timer module for activation

Input.2 for each switch is a ground that will be provided by the timer module

Revisions			
Rev.	Date	Author	Description
v1	03/26/21	Bennet Fisher	Initial Drawing
v2	7/1/2021	Bennet Fisher	Revised pin 4 and 9 connections; spliced switch inputs
v3	7/22/2021	Bennet Fisher	Changed second dome connector
v4	11/8/2021	Bennet Fisher	Eliminated White/Black and Black wire splices; Corrected contacts for C1.4, C1.5, C1.9, and C1.10

UNLESS OTHERWISE SPECIFIED
 DIMENSIONS ARE IN MILLIMETERS (INCHES)
 TOLERANCES: ±5MM

PROPRIETARY AND CONFIDENTIAL

THE INFORMATION CONTAINED IN THIS DRAWING IS THE SOLE PROPERTY OF AAMP GLOBAL. ANY REPRODUCTION IN PART OR AS A WHOLE WITHOUT THE WRITTEN PERMISSION OF AAMP GLOBAL IS PROHIBITED.

	Name	Date
Designed By	Bennet Fisher	3/26/21
Engineering Approval	----	----
Manufacturing Approval	----	----
Revision Approval	----	----
Quality Assurance	----	----



Part Number: P-VTM-HAR_	Revision: ----
Description: Timer Module Harness	Sheet: 1 of 1



VTM

Voltage Timer Module

INSTALLATION MANUAL





Thank you for purchasing the **VTM**



WHAT'S INCLUDED:

- Voltage Timer Module
- Voltage Timer Module Harness
- Screws

COMPATIBLE ACCESSORIES:

- Vehicle-specific harness (P-VTM-xxx)
- Switch harness (VTM-SWx)
- High current harness (VTM-RLY)

FEATURES:

- Selectable timer durations - 60, 90, 120, and 150 minutes
- Low voltage shut off at 11.8V
- Timer and Low Voltage sense work independently of each other
- Inputs for 2 momentary switches
- 7.5A max current output





OPERATING INSTRUCTIONS:

DIP SWITCH 1 UP/DOWN	DIP SWITCH 2 UP/DOWN	DIP SWITCH 3	DIP SWITCH 4	Timer Duration (Minutes)
Voltage Sense ON/OFF	Timer ON/OFF	UP	DOWN	60
		UP	UP	90
		DOWN	UP	120
		DOWN	DOWN	150

If Voltage Sense is turned ON, low voltage shut down will occur when voltage input drops below 11.8V. To eliminate false triggers, there is a 20 second delay before shut down.

If Voltage Sense is turned OFF, input voltage level will not be monitored.

NOTE: Voltage Sense takes precedence over Timer. Voltage Sense is only active when the Switch Inputs are activated. Voltage Sense does not monitor VTM Trigger Input.

If Timer is ON and a switch input is activated, output voltage will be provided for specified timer duration.

While output voltage is active, pressing a switch will disable the output voltage. If pressed once again, output voltage will be re-activated and reset the timer.

Trigger Input	Switch Input	Output	Voltage Sense (ON)	Timer (ON)
Active	N/A	ON	N/A	N/A
Deactivated	N/A	OFF	N/A	N/A
Not Active	Activated (Pressed)	ON	Monitoring Input Voltage	Timer starts
Not Active	Activated (Pressed)	OFF	N/A	Timer off
Not Active	Activated (Pressed)	ON	Monitoring Input Voltage	Timer resets

If VTM Trigger Input to the VTM module is active, its function takes precedence.



WIRING DIAGRAMS:

VTM Harness

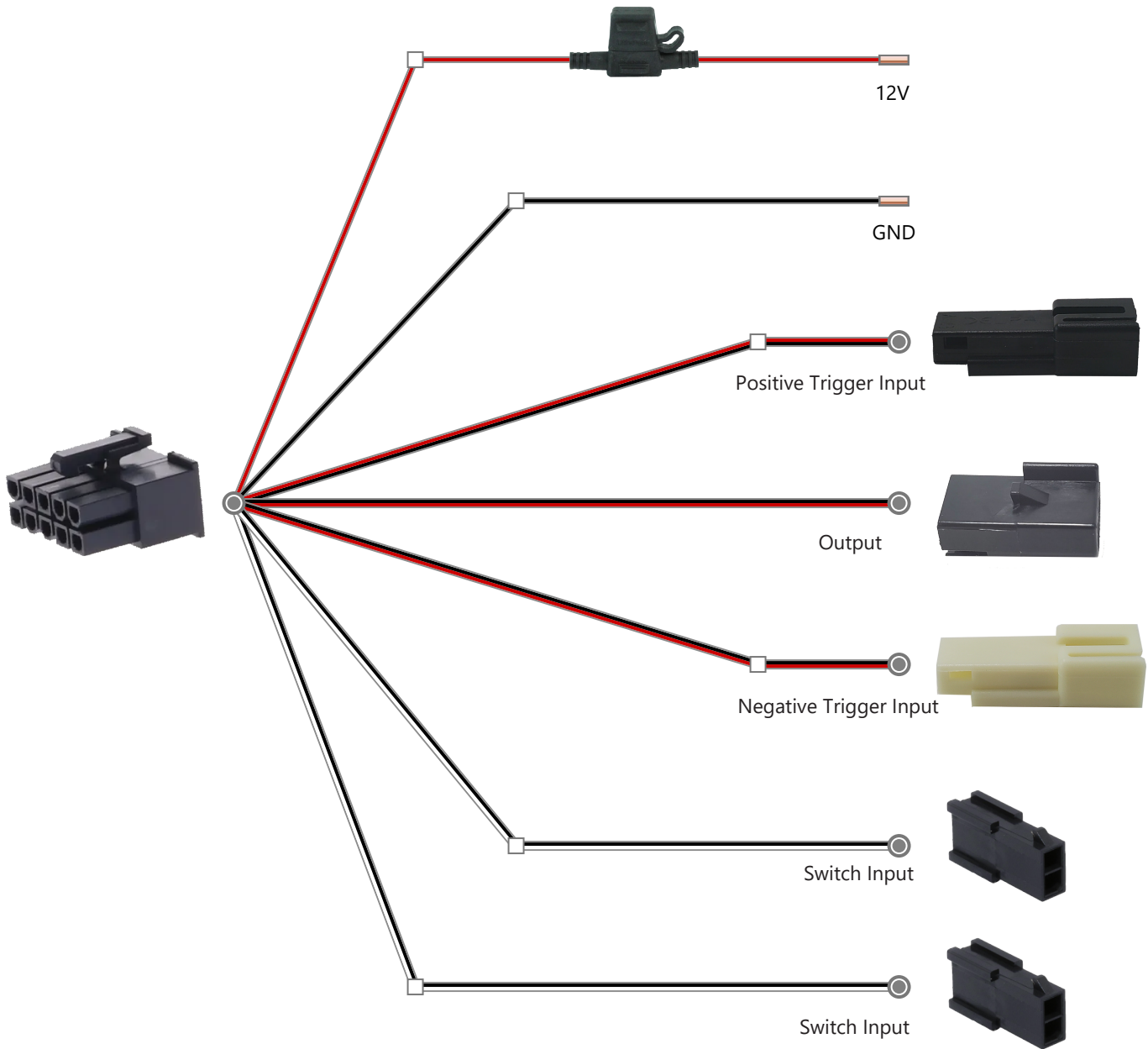

VTM-RLY (Optional Harness)

For larger current demands, use the optional VTM-RLY and connect to power and ground, along with the VTM harness. VTM-RLY supports up to 15A.

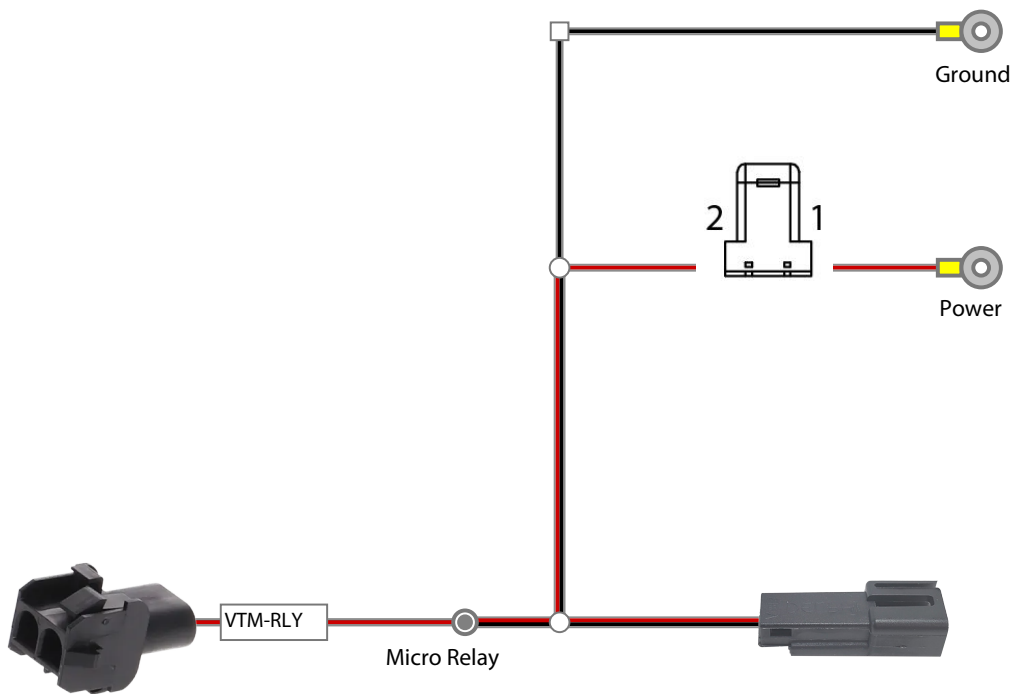

VTM-RLY Output connects to the P-VTMxxx harness for vehicle lighting

VTM-RLY Input connects to the output from the VTM harness





Phone – 866-931-8021 (option 3)

E-Mail – support@echomasterfleetsolutions.com



EchoMaster Fleet Solutions is a Power Brand of AAMP Global

EchoMasterfleetsolutions.com

PURCHASED COMPONENT KEY FEATURES

DESCRIPTION OF REQUIREMENTS

DIMENSIONAL REQUIREMENTS (AS SHOWN ON DRAWING)

N/A

LOAD/RATING REQUIREMENT

N/A

MATERIAL REQUIREMENT

N/A

PACKAGING REQUIREMENT

N/A

OTHER REQUIREMENTS



THIS DRAWING IS THE PROPERTY OF ADRIAN STEEL COMPANY AND IS NOT TO BE USED IN ANY MANNER DETRIMENTAL TO THE INTERESTS OF ADRIAN STEEL COMPANY

TOLERANCES & INSPECTION

UNLESS OTHERWISE SPECIFIED

ALL BEND ANGLES ARE 90 DEGREES

ALL DIMENSIONS ARE IN INCHES.

REFERENCE DIMENSIONS (X.XXX)
DO NOT REQUIRE INSPECTION

FEATURES	HOLES/SLOTS	ANGLES
0.0 = ± .125	0.0 = ± .062	0° = ± 2°
0.00 = ± .062	0.00 = ± .031	0.0° = ± 1°
0.000 = ± .031	0.000 = ± .015	

Material Thickness: per ASTM Std.
Weld Callouts per AWS

RELEASE & REVISIONS

INITIAL ECN: **25377**

CURRENT ECN: **25377**

ECN DESCRIPTION:

RELEASE FOR PRODUCTION

REVISED BY:

PURCHASED COMPONENT

REFERENCED SUPPLIER AND/OR MANUFACTURER

AAMP GLOBAL

REFERENCED SUPPLIER AND/OR MANUFACTURER PART NUMBER

VTM-SW2 OR 65788

COLOR (ONLY LIST IF COLOR SPECIFIC)

COMODITY ITEM (Y/N) (YES = ALL DIMENSIONS AND NOTES ARE REFERENCE)
(NOTE: DIMENSIONS AND FEATURES MAY VARY FOR A COMODITY ITEM.)

NO

PRINTED DOCUMENT IS UNCONTROLLED

Sheet 1 of 1

PART / PRODUCT IDENTIFICATION



ADRIAN STEEL

ADRIAN STEEL COMPANY
906 JAMES STREET, ADRIAN, MI 49221

REVISION LEVEL

A

MAT'L USED: **PURCHASED**

DESIGNED BY: **E.BURKE**



DESCRIPTION: **SWITCH 2 HARNESS FOR VTM**

WEIGHT (Lbs.): **0.2**

SEGMENT CODE: **ELE**

PART NUMBER: **65788**

Coverings	
Id	Assembly
[6]	

From	To	Color	Gauge
C1.1	QC1		20 AWG
C1.2	QC2		20 AWG

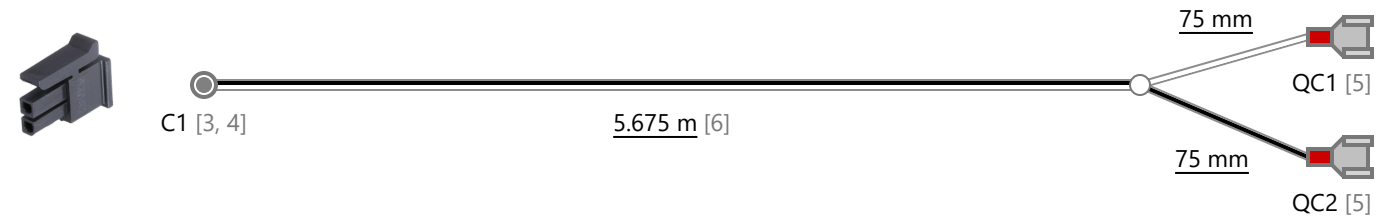

From	To	Color	Gauge
QC1	C1.1		20 AWG

From	To	Color	Gauge
QC2	C1.2		20 AWG



UNLESS OTHERWISE SPECIFIED DIMENSIONS ARE IN MILLIMETERS [INCHES] TOLERANCES: ±5MM PROPRIETARY AND CONFIDENTIAL THE INFORMATION CONTAINED IN THIS DRAWING IS THE SOLE PROPERTY OF AAMP GLOBAL. ANY REPRODUCTION IN PART OR AS A WHOLE WITHOUT THE WRITTEN PERMISSION OF AAMP GLOBAL IS PROHIBITED.		Name	Date	 — ADVANCING VEHICLE TECHNOLOGY —
	Designed By	Bennet Fisher	6/10/2021	
	Engineering Approval			
	Manufacturing Approval			
	Revision Approval			
Quality Assurance				
	Part Number: VTM-SW2		Revision: 1	
	Description: 5.675 Meter Switch Harness		Sheet: ----	

Revisions			
Rev.	Date	Author	Description
1	6/10/21	Bennet Fisher	Initial Drawing

PURCHASED COMPONENT KEY FEATURES

DESCRIPTION OF REQUIREMENTS

DIMENSIONAL REQUIREMENTS (AS SHOWN ON DRAWING)

N/A

LOAD/RATING REQUIREMENT

N/A

MATERIAL REQUIREMENT

N/A

PACKAGING REQUIREMENT

N/A

OTHER REQUIREMENTS



THIS DRAWING IS THE PROPERTY OF ADRIAN STEEL COMPANY AND IS NOT TO BE USED IN ANY MANNER DETRIMENTAL TO THE INTERESTS OF ADRIAN STEEL COMPANY

TOLERANCES & INSPECTION

UNLESS OTHERWISE SPECIFIED

ALL BEND ANGLES ARE 90 DEGREES

ALL DIMENSIONS ARE IN INCHES.

REFERENCE DIMENSIONS (X.XXX)
DO NOT REQUIRE INSPECTION

FEATURES	HOLES/SLOTS	ANGLES
0.0 = ± .125	0.0 = ± .062	0° = ± 2°
0.00 = ± .062	0.00 = ± .031	0.0° = ± 1°
0.000 = ± .031	0.000 = ± .015	

Material Thickness: per ASTM Std.
Weld Callouts per AWS

RELEASE & REVISIONS

INITIAL ECN: **25377**

CURRENT ECN: **25377**

ECN DESCRIPTION:

RELEASE FOR PRODUCTION

REVISED BY:

PURCHASED COMPONENT

REFERENCED SUPPLIER AND/OR MANUFACTURER

AAMP GLOBAL

REFERENCED SUPPLIER AND/OR MANUFACTURER PART NUMBER

VTM-SW4 OR 65790

COLOR (ONLY LIST IF COLOR SPECIFIC)

COMODITY ITEM (Y/N) (YES = ALL DIMENSIONS AND NOTES ARE REFERENCE)
(NOTE: DIMENSIONS AND FEATURES MAY VARY FOR A COMODITY ITEM.)

NO

PRINTED DOCUMENT IS UNCONTROLLED

Sheet 1 of 1

PART / PRODUCT IDENTIFICATION



ADRIAN STEEL

ADRIAN STEEL COMPANY
906 JAMES STREET, ADRIAN, MI 49221

REVISION LEVEL

A

MAT'L USED: **PURCHASED**

DESIGNED BY: **E.BURKE**



DESCRIPTION: **SWITCH 4 HARNESS FOR VTM**

WEIGHT (Lbs.): **0.2**

SEGMENT CODE: **ELE**

PART NUMBER: **65790**

Coverings	
Id	Assembly
[6]	

From	To	Color	Gauge
C1.1	QC1		20 AWG
C1.2	QC2		20 AWG

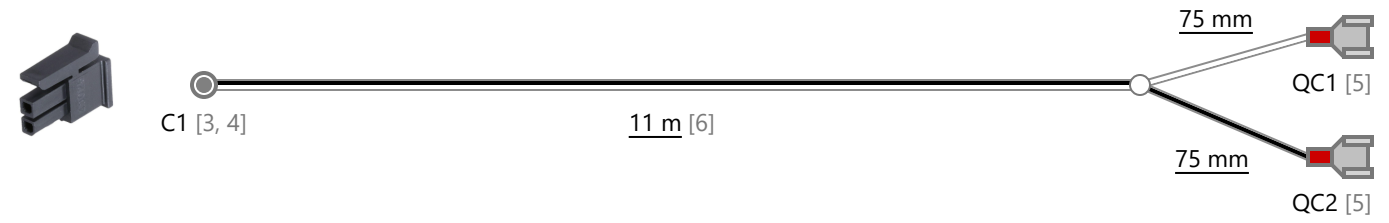

From	To	Color	Gauge
QC1	C1.1		20 AWG

From	To	Color	Gauge
QC2	C1.2		20 AWG



<p>UNLESS OTHERWISE SPECIFIED DIMENSIONS ARE IN MILLIMETERS [INCHES] TOLERANCES: ±5MM</p> <p>PROPRIETARY AND CONFIDENTIAL</p> <p>THE INFORMATION CONTAINED IN THIS DRAWING IS THE SOLE PROPERTY OF AAMP GLOBAL. ANY REPRODUCTION IN PART OR AS A WHOLE WITHOUT THE WRITTEN PERMISSION OF AAMP GLOBAL IS PROHIBITED.</p>		Name	Date	 <p>— ADVANCING VEHICLE TECHNOLOGY —</p>
	Designed By	Bennet Fisher	6/10/2021	
	Engineering Approval			
	Manufacturing Approval			
	Revision Approval			
Quality Assurance				
	Part Number: VTM-SW4		Revision: 1	
	Description:		Sheet:	
	11 Meter Switch Harness		----	

Revisions			
Rev.	Date	Author	Description
1	6/10/21	Bennet Fisher	Initial Drawing

PURCHASED COMPONENT KEY FEATURES

DESCRIPTION OF REQUIREMENTS

DIMENSIONAL REQUIREMENTS (AS SHOWN ON DRAWING)

N/A

LOAD/RATING REQUIREMENT

N/A

MATERIAL REQUIREMENT

N/A

PACKAGING REQUIREMENT

N/A

OTHER REQUIREMENTS

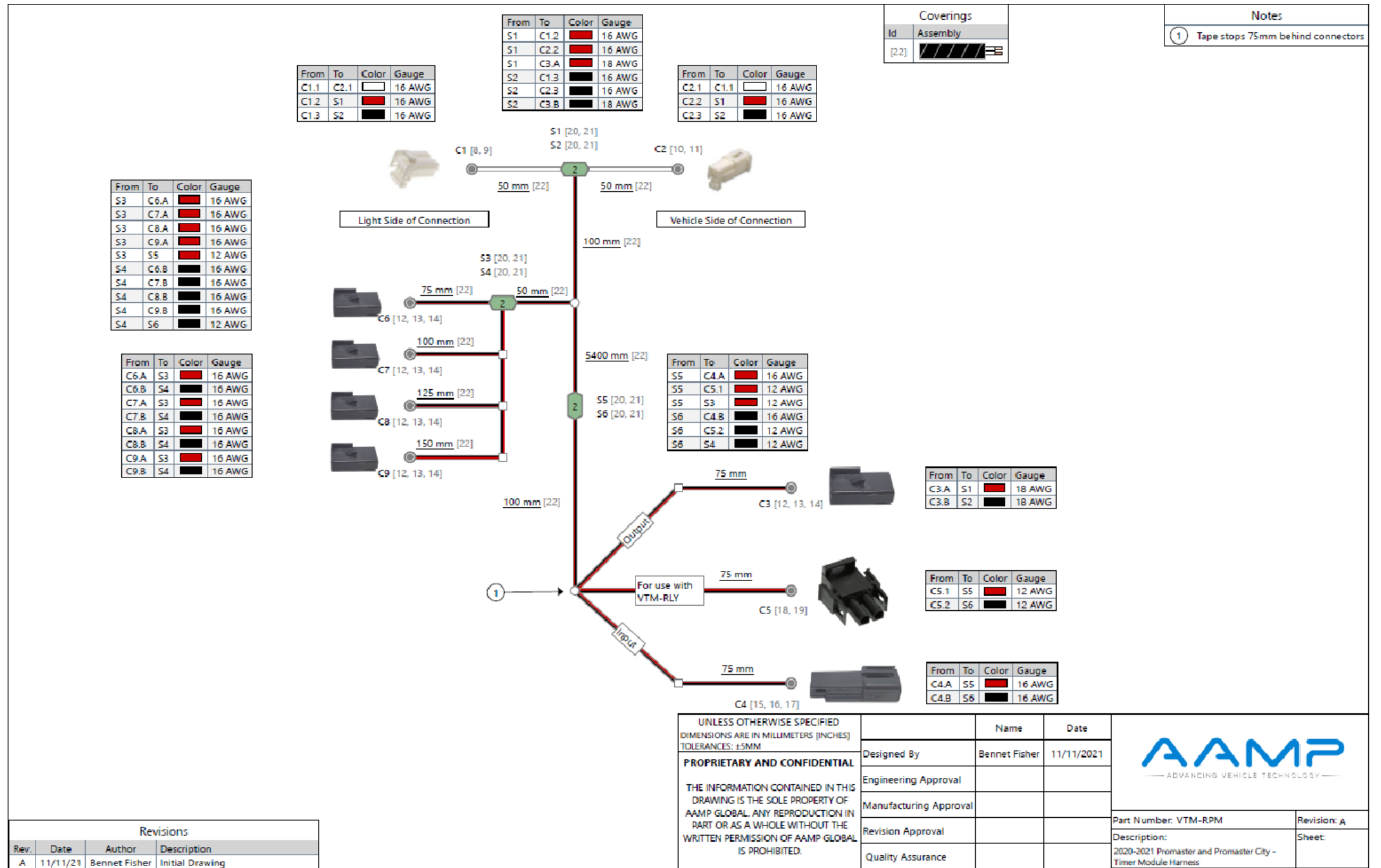

THIS DRAWING IS THE PROPERTY OF ADRIAN STEEL COMPANY AND IS NOT TO BE USED IN ANY MANNER DETRIMENTAL TO THE INTERESTS OF ADRIAN STEEL COMPANY

TOLERANCES & INSPECTION

UNLESS OTHERWISE SPECIFIED
 ALL BEND ANGLES ARE 90 DEGREES
 ALL DIMENSIONS ARE IN INCHES.
 REFERENCE DIMENSIONS (X.XXX)
 DO NOT REQUIRE INSPECTION

FEATURES	HOLES/SLOTS	ANGLES
0.0 = ± .125	0.0 = ± .062	0° = ± 2°
0.00 = ± .062	0.00 = ± .031	0.0° = ± 1°
0.000 = ± .031	0.000 = ± .015	

Material Thickness: per ASTM Std.
 Weld Callouts per AWS

RELEASE & REVISIONS

INITIAL ECN: **25377**
 CURRENT ECN: **27060**
 ECN DESCRIPTION:
PPDS Change: Manuf# and Description
 REVISED BY: **MLH**

PURCHASED COMPONENT

REFERENCED SUPPLIER AND/OR MANUFACTURER
AAMP GLOBAL

REFERENCED SUPPLIER AND/OR MANUFACTURER PART NUMBER
VTM-RPM

COLOR (ONLY LIST IF COLOR SPECIFIC)
NO

COMODITY ITEM (Y/N) (YES = ALL DIMENSIONS AND NOTES ARE REFERENCE)
 (NOTE: DIMENSIONS AND FEATURES MAY VARY FOR A COMODITY ITEM.)
NO

PRINTED DOCUMENT IS UNCONTROLLED

Sheet 1 of 1

PART / PRODUCT IDENTIFICATION

ADRIAN STEEL	ADRIAN STEEL COMPANY 906 JAMES STREET, ADRIAN, MI 49221	REVISION LEVEL A
MAT'L USED: PURCHASED	DESIGNED BY: E.BURKE	
DESCRIPTION: HARN, POWER VTM-RPM		
WEIGHT (Lbs.): 0.2	SEGMENT CODE: ELE	PART NUMBER: 65796

PURCHASED COMPONENT KEY FEATURES

DESCRIPTION OF REQUIREMENTS

DIMENSIONAL REQUIREMENTS (AS SHOWN ON DRAWING)

N/A

LOAD/RATING REQUIREMENT

N/A

MATERIAL REQUIREMENT

N/A

PACKAGING REQUIREMENT

N/A

OTHER REQUIREMENTS

**RING TERMINAL:
16-14GA
1/4" STUD SIZE
BLUE
TIN PLATED COPPER**



THIS DRAWING IS THE PROPERTY OF ADRIAN STEEL COMPANY AND IS NOT TO BE USED IN ANY MANNER DETRIMENTAL TO THE INTERESTS OF ADRIAN STEEL COMPANY

TOLERANCES & INSPECTION

UNLESS OTHERWISE SPECIFIED

ALL BEND ANGLES ARE 90 DEGREES

ALL DIMENSIONS ARE IN INCHES.

REFERENCE DIMENSIONS (X.XXX)
DO NOT REQUIRE INSPECTION

FEATURES	HOLES/SLOTS	ANGLES
0.0 = ± .125	0.0 = ± .062	0° = ± 2°
0.00 = ± .062	0.00 = ± .031	0.0° = ± 1°
0.000 = ± .031	0.000 = ± .015	

Material Thickness: per ASTM Std.
Weld Callouts per AWS

RELEASE & REVISIONS

INITIAL ECN: **25975**

CURRENT ECN: **25975**

ECN DESCRIPTION:

RELEASE TO PRODUCTION

REVISED BY: **N/A**

PURCHASED COMPONENT

REFERENCED SUPPLIER AND/OR MANUFACTURER

WAYTEK

REFERENCED SUPPLIER AND/OR MANUFACTURER PART NUMBER

37393

COLOR (ONLY LIST IF COLOR SPECIFIC)

BLUE

COMODITY ITEM (Y/N) (YES = ALL DIMENSIONS AND NOTES ARE REFERENCE)
(NOTE: DIMENSIONS AND FEATURES MAY VARY FOR A COMODITY ITEM.)

NO

PRINTED DOCUMENT IS UNCONTROLLED

Sheet 1 of 1

PART / PRODUCT IDENTIFICATION



ADRIAN STEEL®

ADRIAN STEEL COMPANY
906 JAMES STREET, ADRIAN, MI 49221

REVISION LEVEL

A

MAT'L USED: **PURCHASED**

DESIGNED BY: **EMB**

DESCRIPTION: **WIRE TERM 1/4"RING 14-16G**

WEIGHT (Lbs.): **0.01**

SEGMENT CODE: **ELE**

PART NUMBER: **69511**