

## Part Number

**69623**

**Module LED Light (69623)**

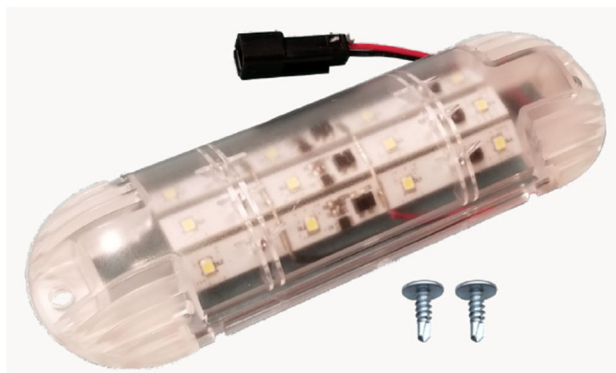

**Roof Bow Harness #2 (63482)**



## PRODUCT FEATURES

- This kit is compatible with the Ford Transit Connect.
- Included in this kit is one (1) module LED light (63480), roof bow harness #2 (63482), two switches, power harness (65795), and various fasteners.
- There are no OEM options that this kit is not compatible with and there are no OEM options that are required for this kit.

Model Year Validated:

2023

## Introduction / Comments:

Install Instructions For Interior Plug & Play Lights For Transit Connect

### **Note:**

Read all instructions prior to installation. Review the Adrian Steel **GENERAL PRECAUTIONS PAGES (56638)** before attempting installation. Only personnel familiar with using electrical best practices should perform this install. Reference **ELECTRICAL BEST PRACTICES MANUAL (54479)** before attempting installation.



## Installation Instructions For Interior Plug And Play Lights For Transit Connect

**\*\*Please read statement below before moving forward\*\***

These plug and play kits are completely modular and can be configured in many different ways. Placement of lights will be determined by sales order drawings/customer ask. Therefore, these instructions are for the most standard configurations, and for reference only. The only harness that is specific to the transit connect vehicle is the power harnesses 65795. Routing will be very standard across all kits, but placement of lights and switches are subject to be different from these instructions if called out on the order drawing differently.

## Overall Harness Diagram

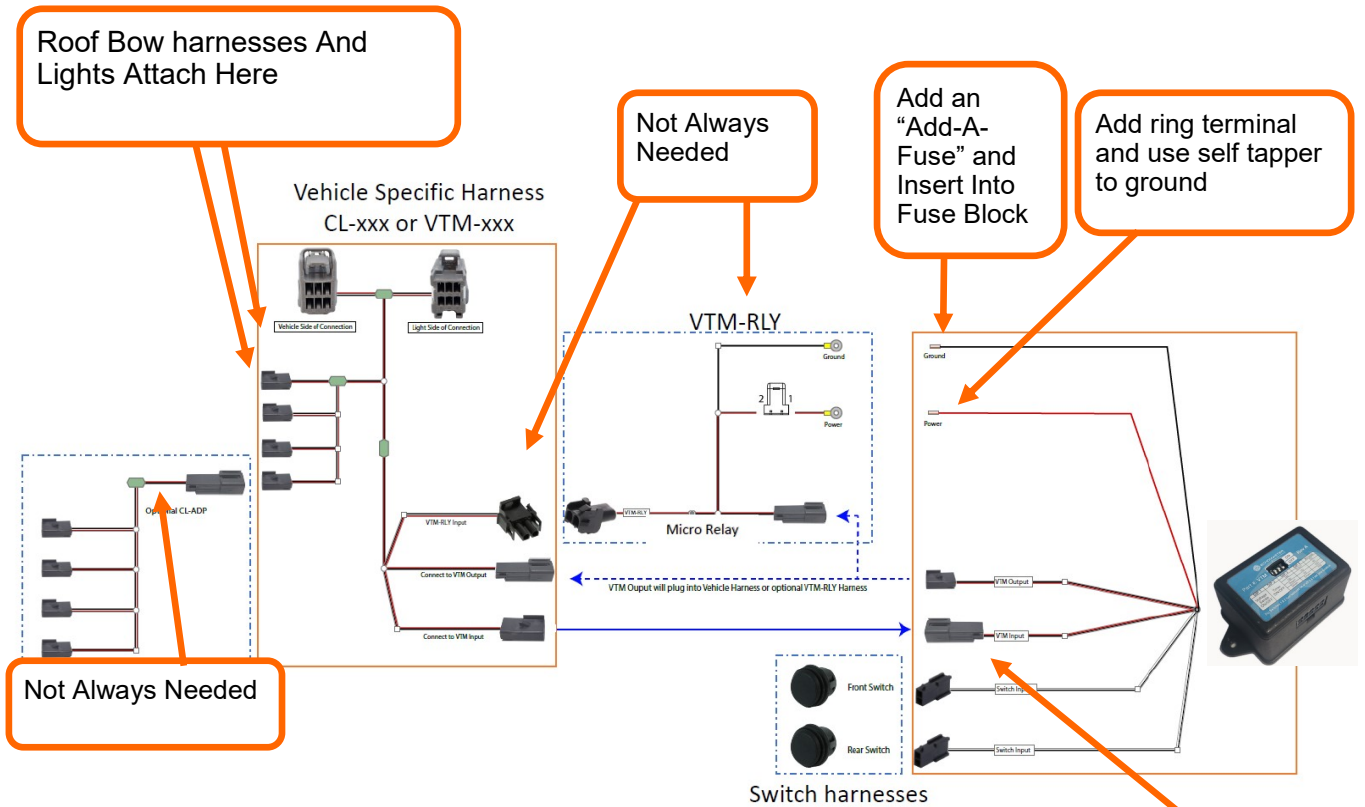

### Tools required:

Crimpers

Power drill:  
3/8" step drill bit  
Philips head bit



For all vehicles that are NOT RAM. This connector will be black. RAM vehicles, this will be white. See page 4 for more details.

# Specific Harness Diagram

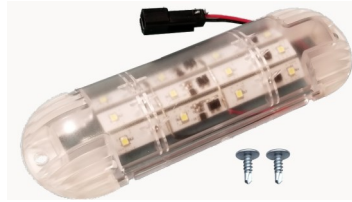

Roof Bow Harnesses and Lights Connect Here

Vehicle Specific Harness  
CL-xxx or VTM-xxx

Insert into OEM Light Connector:  
See Below

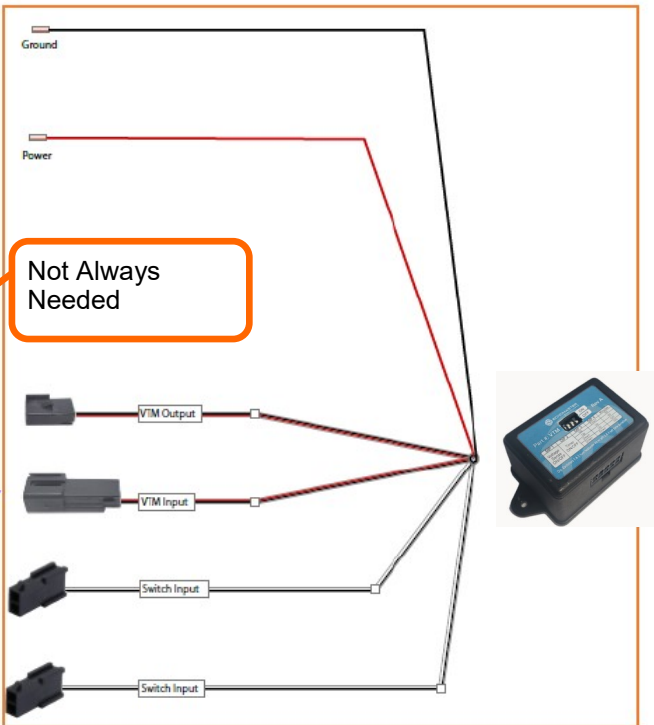
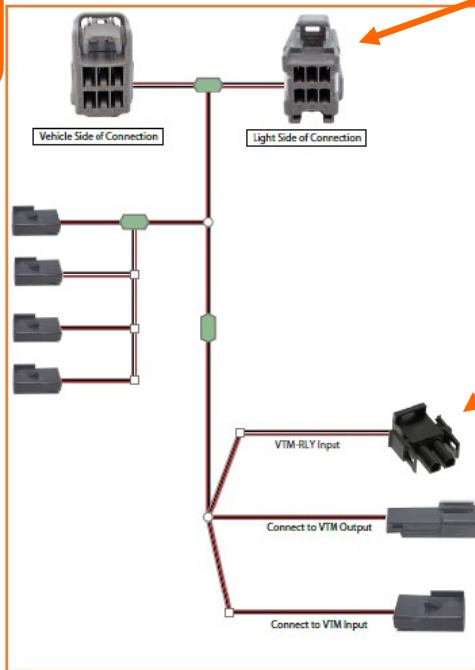

Switch  
Harness in  
between

Connector Location  
Behind Airbag Foam

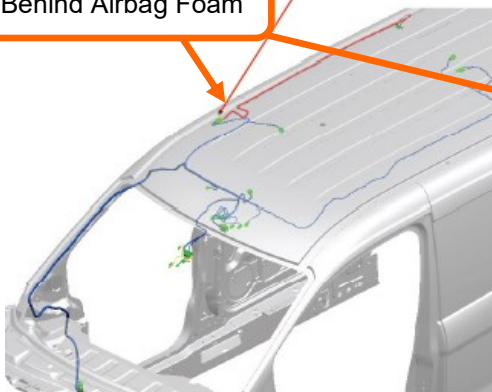

OEM Connector Behind  
Foam in Headliner



## Voltage Timer Module (VTM) Harness Reference

For all vehicles except RAM, the black input connector will be used to plug into the vehicle specific harness. The white connector will NOT be used.

For all RAM vehicles, the white connector will be used to plug into the vehicle specific harness. The black connector will NOT be used.

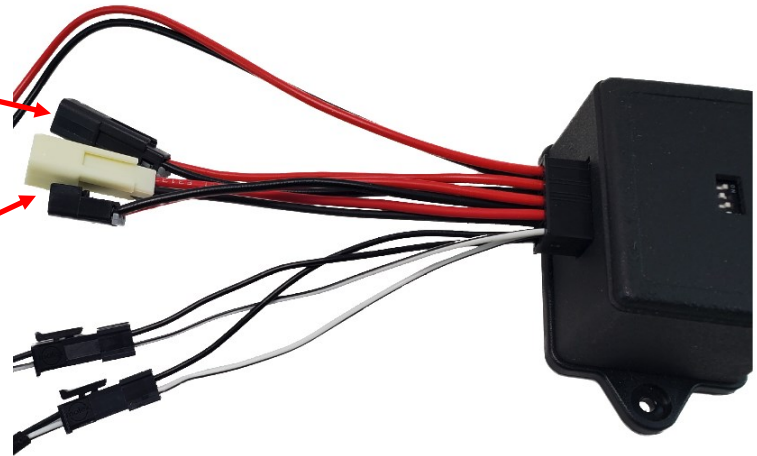

### Harnesses Needed

	Part Number	Description
1	65786	Voltage Timer Module (VTM)
2	63480 Or/And 64222, 65346, 65347, 65348	Dome Light Or/And Strip Lights
3	63481 Or/And 63842, 63483, 63484	Roof Bow Harnesses 1 through 4
4	65795	Power Harness
5	65787 Or/And 65788, 65789, 65790	Switch Harness 1 through 4 for VTM

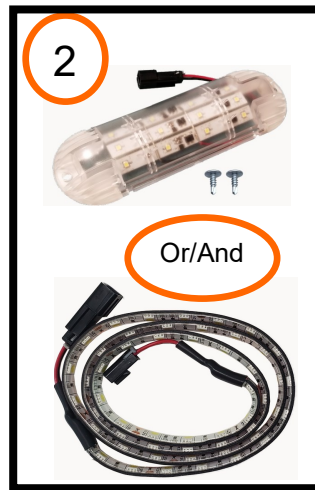

Harness pictures are for reference only.

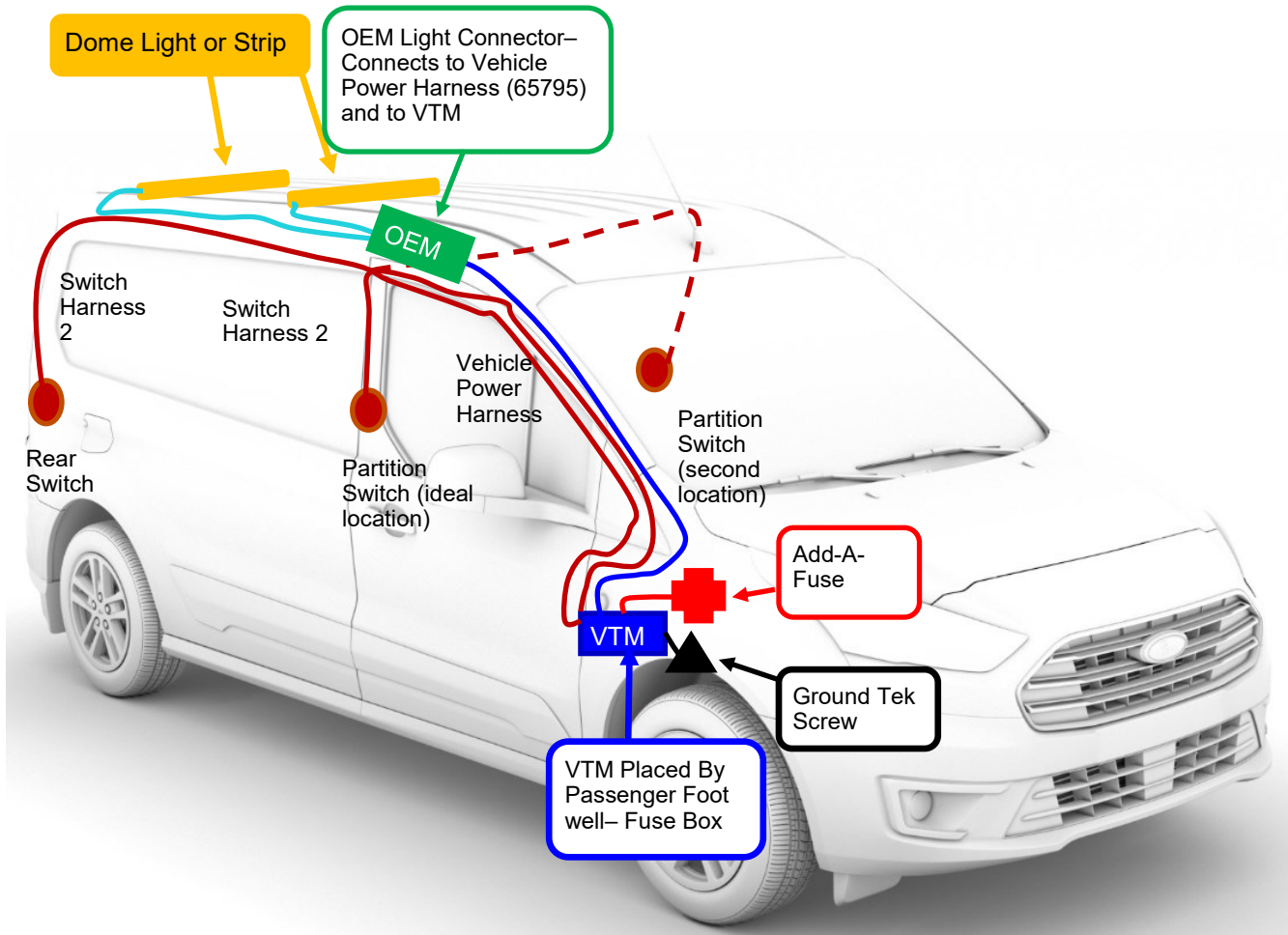

Color	Key - Items
Blue	VTM/Harness
Green	Vehicle Specific Power Harness
Black	Ground Location
Red	12V location
Redish/Brown	Switch Harnesses
Yellow	Dome or Strip Lights
Teal	Roof Bow Harnesses

**The purpose of plug and play lighting is to be completely modular. Due to this feature, refer to the order drawing for all exact lighting placements. These installation instructions are for most cases and for reference.**

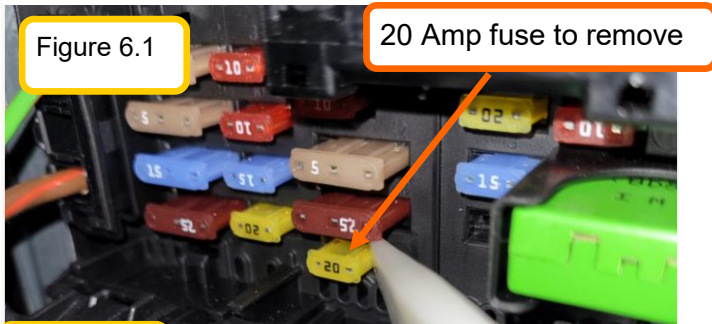

Figure 6.1

20 Amp fuse to remove

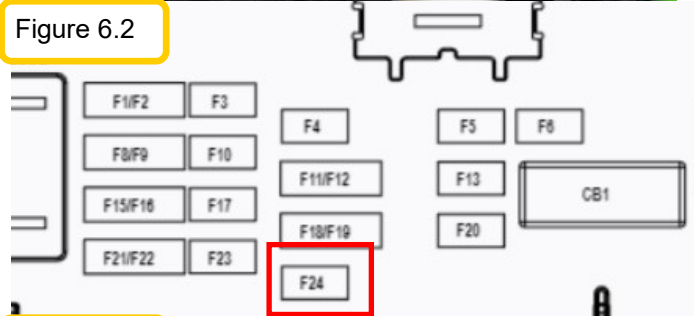

Figure 6.2

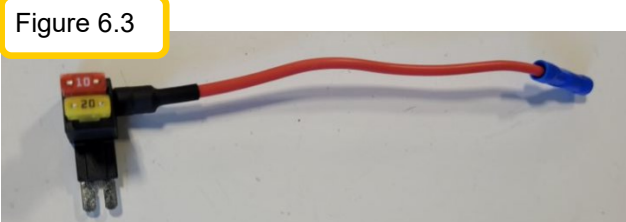

Figure 6.3



Figure 6.4



Figure 6.5

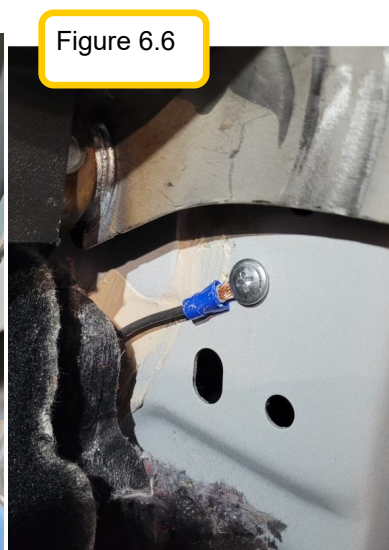

Figure 6.6

**Step 1:** Locate the VTM power harness #65786

Attach the Micro Add-A-Fuse to the blunt cut red wire.

Attach the 1/4" ring terminal to the black wire

Remove the fuse from the inline fuse holder until the end of the install

Plug the harness connector into the voltage timer module port

**Step 2:** Locate the Fuse panel under the passenger side foot well. You will need to remove the glove box and some trim to see the fuse box.

Locate the 20 amp micro (F24) fuse shown in figure 6.1 and 6.2.. Remove the fuse carefully.

Insert the supplied 7.5A fuse into the add-a-fuse holder on the top portion of the insert.

Insert the OEM 20A fuse into the add-a-fuse in the bottom portion of the insert. Figure 6.2.

Insert the add-a-fuse back into the 20A fuse location. Figure 6.4.

Remove the trim panel on the body of the passenger side kick panel. Figure 6.5.

Use the self tapping screw (FAS0148) to ground the ring terminal/ground wire to the body of the van. Figure 6.6.

**Step 3:** Apply the VHB tape the back of the VTM (voltage timer module). See figure 6.7.



Figure 6.7

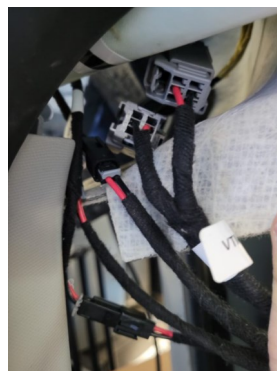
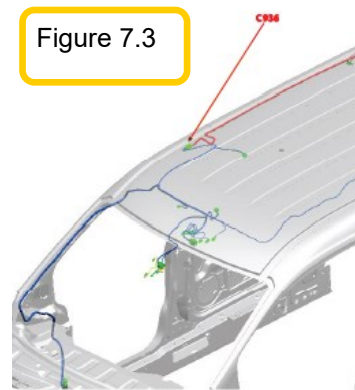
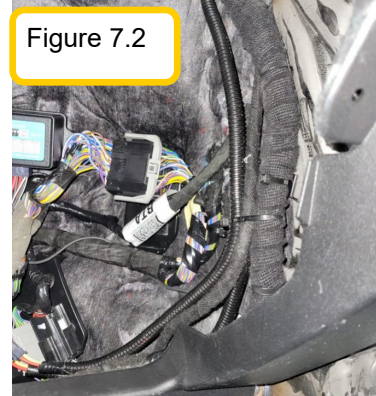
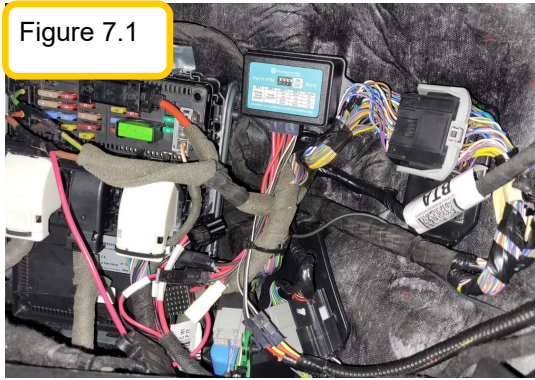

Place the VTM to the right of the fuse block like shown in figure 7.1. Secure the VTM to the OEM wire harnesses as needed with zip ties.

**\*\*\*Please be sure to set all the dip switches on the VTM UP\*\*\***

Refer to the bottom picture for dip switch settings. If the customer would like a different amount time other than 90 minutes, use the dip switches to set the time.

Plug the switch 2 harnesses (65788) into the VTM harness. See pages 2 & 3 for reference.

Secure wiring to the OEM harnesses as needed. Figure 7.2.

**Step 4:** Locate the OEM light connector that is located in the headliner, behind the foam. Figure 7.3. You will need to remove the foam block on 2022+ Transit Connects.

Carefully remove it from the vehicle. You will need to enter the vehicle through the passenger side slider door and remove the block by pulling down the rear passenger corner of the headliner, then pull the block straight back towards the rear of the vehicle.

The foam block needs to be re-installed after installation of lights is complete.

Disconnect the OEM connectors and plug in the ASCO connector to each side. Figure 7.4.

Connect the roof bow harnesses (63481 Or/And 63842, 63483, 63484 all that are applicable) to the power harness.

Use zip ties/fir trees to secure all wiring.

**Step 5:** Disassemble the A-pillar trim. Be careful not to interfere with any air bags or wiring.

DIP SWITCH 1 UP/DOWN	DIP SWITCH 2 UP/DOWN	DIP SWITCH 3	DIP SWITCH 4	Timer Duration (Minutes)
Voltage Sense ON/OFF	Timer ON/OFF	UP	DOWN	60
		UP	UP	90
		DOWN	UP	120
		DOWN	DOWN	150

**VTM Dip Switch Settings**



Figure 10.1

Route the switch harnesses up the A-pillar, to the top of the partition area. These will be routed to their locations on the next page. Do not interfere with any airbag wiring.

Route the power harness the opposing way, down the A-pillar to the VTM. Figures 10.0 and 10.2.



Figure 10.2



Figure 10.3

End to route to the VTM

Plug the power harness into the VTM, using only the input and output connectors. The relay connector will not be used. Reference page 3 for connections, and figure 10.3.

Be sure to use the black colored VTM input connector referenced on page 4. The white connector will NOT be used for this install.

Secure wiring with zip ties.

**Step 6:** Plug the roof bow harnesses into the power harness in the headliner area.

Route the roof bow harnesses to the light locations on the roof bows. Be sure to confirm placement of lights with the order drawing. Ideal placements are the very rear door pillar and the last roof bow.



Figure 10.4

Use the OEM roof channels and fir tree zip ties for securing the wiring. Figures 10.4 and 10.5.

**Step 7:** Before mounting any lights, prep the surface where the light will be placed with the supplied alcohol pad. Let dry for a few minutes, then mount the light.



Figure 10.5

**Be sure the surface is clean before applying the VHB tape. Read the supplied instructions in the lighting boxes.**

Mount the strip/dome lights to their desired locations: Refer to the order drawing.

For dome lights, use the VHB tape already on the back of the light, and also secure with the supplied tek screws. Figure 10.6.

Dome lights are to be placed as close to the center of the roof bow as possible, while straddling the gaps in the roof bow.

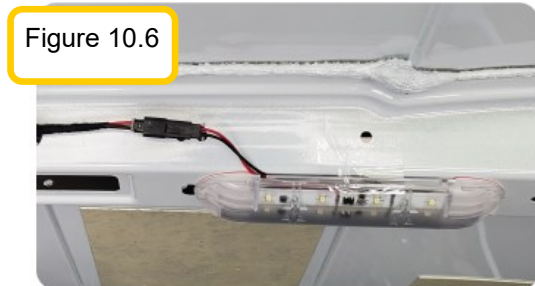
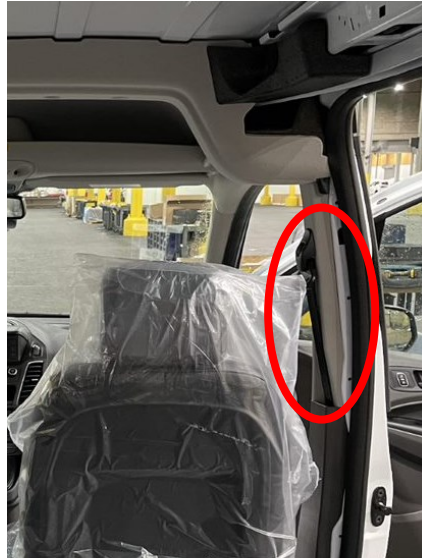

Figure 10.6

For the strip lights, use the VHB tape supplied on the back of the lights, and use the little square sticky backs with zip ties that are supplied in the box.

Figure 11.1



**Partition Switch**

**Locations:**

Switch hole in steel partition (figure 11.1) or drill out switch hole in composite partition (figure 11.2).

This location will require harness #65788.

**Rear Switch Location:**

Passenger side rear D-pillar trim.

2.5" left of the D-pillar and 3.5" down from the top edge of the trim.

See figure 11.3 below for reference.

Figure 11.2

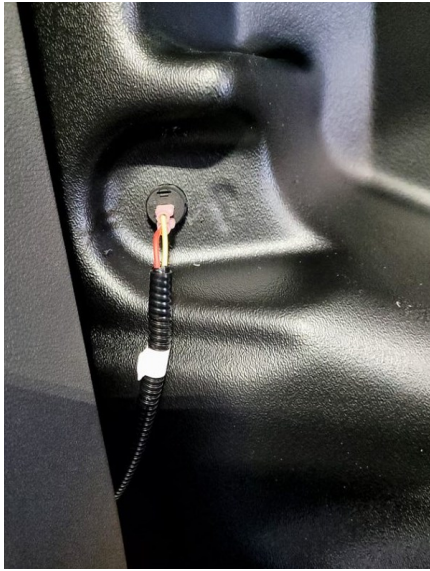
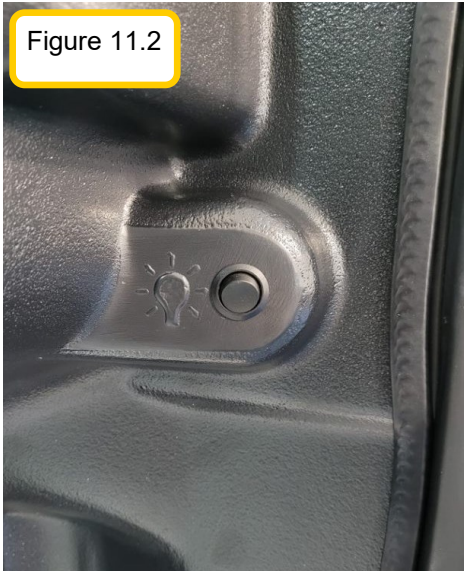

This location will also require harness #65788.

**Step 8:** Route the front switch harness from the VTM harness location to the partition switch location. (From fuse box under passenger side seat, up the A-pillar, then down the partition to the switch hole.

Do the same with the rear harness the D-pillar switch location. Route in the upper channels on the van to the D-pillar then to the switch location.

Figure 11.3



Reference page 5 for routing paths.

Use Zip ties to secure wiring.

Drill needed holes for the switches in rear D pillar trim panel, and composite partition (if applicable).

Insert the switches into the holes with the "1" in the 12:00 position, connect the harness (the connection orientation does not matter).

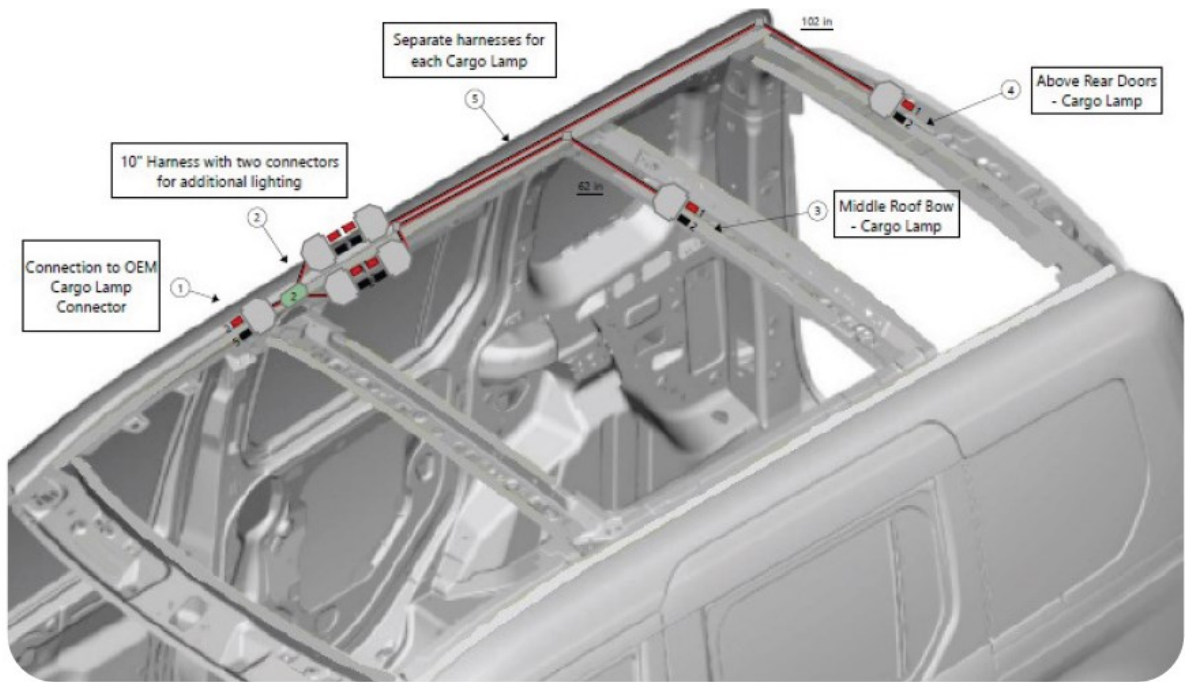

Final install reference pictures

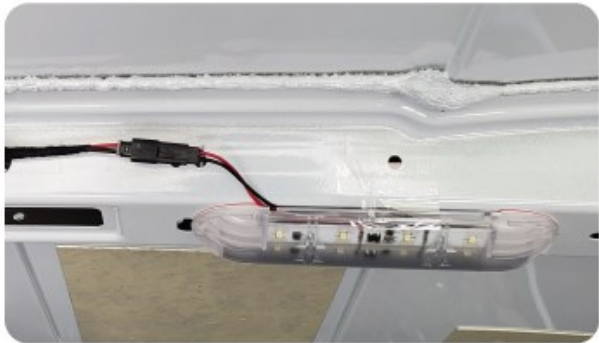

Insert the fuse into the inline-fuse holder on the power harness. The install is now complete. Secure all wiring with zip ties. Re-attach all trim. Double check the functionality of the lights and switches.

PART NUMBER

13905-0

**ITEM DESCRIPTION: WIRE TIE, NYLON 40Lb, 8.5" BLACK**



MANUFACTURER: WAYTEK, INC. or equivalent  
MANUFACTURERS PART NUMBER: 21093M or 21093C

SPECIFICATIONS:     STANDARD CABLE TIE  
                          BLACK, NYLON  
                          8-1/2" LONG  
                          TENSILE STRENGTH: 40.0 LBS  
                          21093M = 1,000 quantity  
                          21093C = 100 quantity

SPECIAL NOTES: PART NUMBER IS BLACK.

**SUPPLIED BY: THIS ITEM IS ADRIAN AVAILABLE!**

**PURCHASED PRODUCT DATA SHEET (PPDS)**

THIS DRAWING/INFORMATION IS THE PROPERTY OF ADRIAN STEEL COMPANY AND IS NOT TO BE USED IN ANY MANNER THAT IS DETRIMENTAL TO THE INTEREST OF ADRIAN STEEL. COPYRIGHTS AND OR PATENTS THAT MAY BE THE PROPERTY OF APPLICABLE OWNERS MAY PROTECT INFORMATION AND/OR DRAWINGS OF SUPPLIED PRODUCTS.



**ADRIAN STEEL**  
VAN AND PICKUP EQUIPMENT

906 JAMES STREET  
ADRIAN, MI 49221  
517-265-6194  
WWW.ADRIANSTEEL.COM



**CAUTION**

**WHEN INSTALLING EQUIPMENT IN OR ON VEHICLES CHECK FOR FUEL TANKS, FUEL LINES, CONTROL LINES AND ELECTRICAL WIRING BEFORE DRILLING! ALWAYS USE DRILL BITS WITH INTEGRAL STOPS WHENEVER POSSIBLE!**

DRAWN BY  
MDG

DATE DRAWN  
10/26/2006

ECN NUMBER  
18021

ECN DATE  
11/13/2015

PART WEIGHT  
0.01 LBS.

REV. LEVEL  
D

PART NUMBER  
**13905-0**

# PURCHASED COMPONENT KEY FEATURES

## DESCRIPTION OF REQUIREMENTS

DIMENSIONAL REQUIREMENTS (AS SHOWN ON DRAWING)

**Base is a 0.975 inch square**

LOAD/RATING REQUIREMENT

N/A

MATERIAL REQUIREMENT

N/A

PACKAGING REQUIREMENT

N/A

OTHER REQUIREMENTS

**Black adhesive wire tie mounting base.**

Cure Time: Bond 15 Min., Max  
Adhesion 1 Hr.

Max. Operating 158

Temp. F:

Max. Operating 70

Temp. C:

Min. Installation 65

Temp. F:

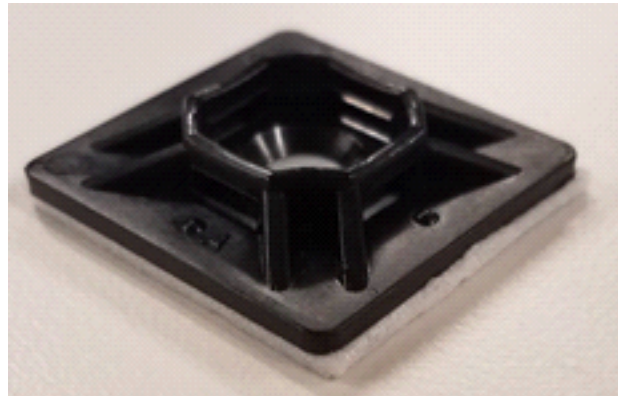

THIS DRAWING IS THE PROPERTY OF ADRIAN STEEL COMPANY AND IS NOT TO BE USED IN ANY MANNER DETRIMENTAL TO THE INTERESTS OF ADRIAN STEEL COMPANY

## TOLERANCES & INSPECTION

UNLESS OTHERWISE SPECIFIED

ALL BEND ANGLES ARE 90 DEGREES

ALL DIMENSIONS ARE IN INCHES.

REFERENCE DIMENSIONS (X.XXX)

DO NOT REQUIRE INSPECTION

FEATURES	HOLES/SLOTS	ANGLES
0.0 = ± .125	0.0 = ± .062	0° = ± 2°
0.00 = ± .062	0.00 = ± .031	0.0° = ± 1°
0.000 = ± .031	0.000 = ± .015	

Material Thickness: per ASTM Std.

Weld Callouts per AWS

## RELEASE & REVISIONS

INITIAL ECN: 17429

CURRENT ECN: 22185

ECN DESCRIPTION:

**Size of the base changed with a change in supplier**

REVISED BY: D. LaCroix

# PURCHASED COMPONENT

REFERENCED SUPPLIER AND/OR MANUFACTURER

**Midstate**

REFERENCED SUPPLIER AND/OR MANUFACTURER PART NUMBER

**49401**

COLOR (ONLY LIST IF COLOR SPECIFIC)

COMMODITY ITEM (Y/N) (YES = ALL DIMENSIONS AND NOTES ARE REFERENCE)  
(NOTE: DIMENSIONS AND FEATURES MAY VARY FOR A COMMODITY ITEM.)

**YES**

PRINTED DOCUMENT IS UNCONTROLLED

Sheet 1 of 1

## PART / PRODUCT IDENTIFICATION



**ADRIAN STEEL**

ADRIAN STEEL COMPANY  
906 JAMES STREET, ADRIAN, MI 49221

REVISION LEVEL

**B**

MAT'L USED:

DESIGNED BY: **RJB**

DESCRIPTION:

**Adhesive wire tie base**

WEIGHT (Lbs.):

**0.05**

SEGMENT CODE:

**HDW**

PART NUMBER: **49401**

**ITEM DESCRIPTION: MICRO2 ADD-A-FUSE FUSE HOLDER**



MANUFACTURER: WAYTEK  
 MANUFACTURERS PART NUMBER: 46177 or similar

SPECIFICATIONS: (1) Add-A-Fuse Micro2 style

SPECIAL NOTES: None.

**SUPPLIED BY: THIS ITEM IS ADRIAN AVAILABLE!**

**PURCHASED PRODUCT DATA SHEET (PPDS)**

THIS DRAWING/INFORMATION IS THE PROPERTY OF ADRIAN STEEL COMPANY AND IS NOT TO BE USED IN ANY MANNER THAT IS DETRIMENTAL TO THE INTEREST OF ADRIAN STEEL. COPYRIGHTS AND OR PATENTS THAT MAY BE THE PROPERTY OF APPLICABLE OWNERS MAY PROTECT INFORMATION AND/OR DRAWINGS OF SUPPLIED PRODUCTS.



**906 JAMES STREET  
 ADRIAN, MI 49221  
 517-265-6194  
 WWW.ADRIANSTEEL.COM**

**⚠ CAUTION ⚠**

**WHEN INSTALLING EQUIPMENT IN OR ON VEHICLES CHECK FOR FUEL TANKS, FUEL LINES, CONTROL LINES AND ELECTRICAL WIRING BEFORE DRILLING! ALWAYS USE DRILL BITS WITH INTEGRAL STOPS WHENEVER POSSIBLE!**

<b>DRAWN BY</b> RJB	<b>DATE DRAWN</b> 08/27/2015
<b>ECN NUMBER</b> 17776	<b>ECN DATE</b> 08/27/2015
<b>PART WEIGHT</b> 0.01 LBS.	<b>REV. LEVEL</b> A
<b>PART NUMBER</b> <b>49987</b>	

# PURCHASED COMPONENT KEY FEATURES

## DESCRIPTION OF REQUIREMENTS

DIMENSIONAL REQUIREMENTS (AS SHOWN ON DRAWING)

N/A

LOAD/RATING REQUIREMENT

N/A

MATERIAL REQUIREMENT

N/A

PACKAGING REQUIREMENT

N/A

OTHER REQUIREMENTS

(1) LED LIGHT WITH 12 LED GROUPED IN THREE ROWS

(2) TEK SCREWS INCLUDED

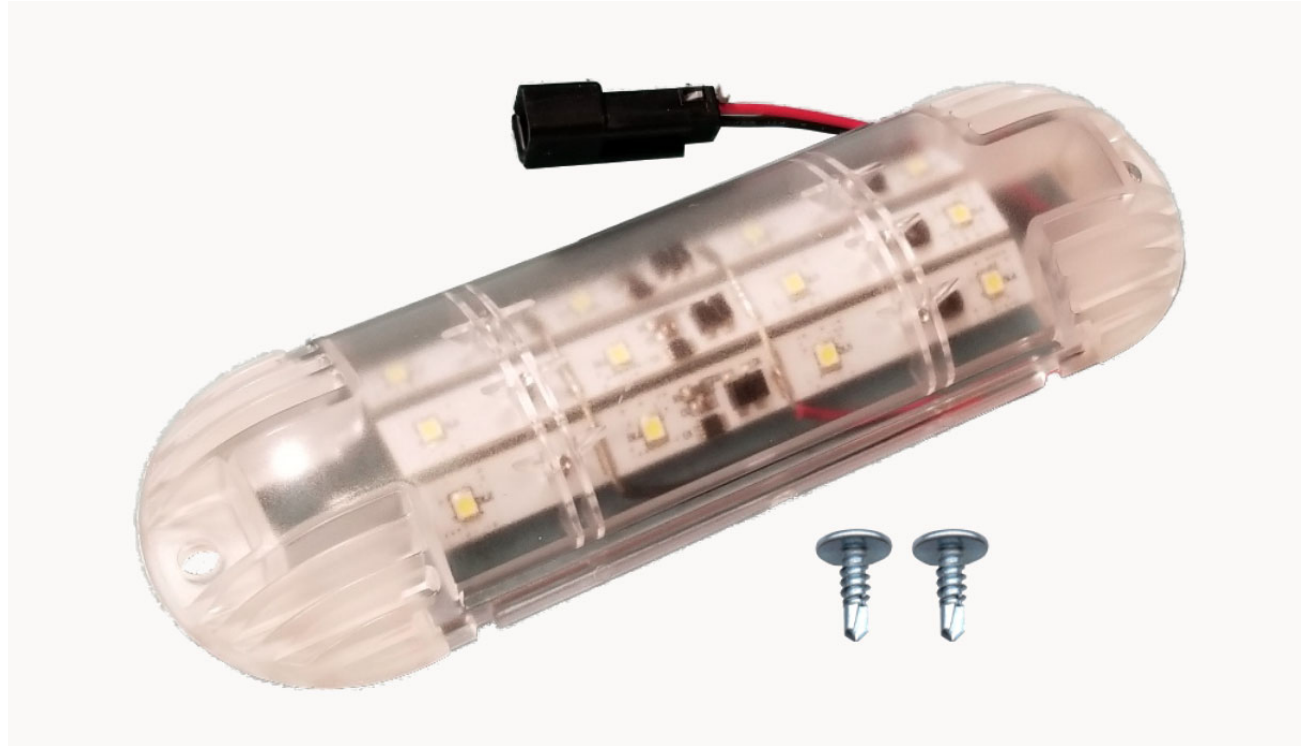

THIS DRAWING IS THE PROPERTY OF ADRIAN STEEL COMPANY AND IS NOT TO BE USED IN ANY MANNER DETRIMENTAL TO THE INTERESTS OF ADRIAN STEEL COMPANY

## TOLERANCES & INSPECTION

UNLESS OTHERWISE SPECIFIED

ALL BEND ANGLES ARE 90 DEGREES

ALL DIMENSIONS ARE IN INCHES.

REFERENCE DIMENSIONS (X.XXX)

DO NOT REQUIRE INSPECTION

FEATURES	HOLES/SLOTS	ANGLES
0.0 ± .125	0.0 ± .062	0° ± 2°
0.00 ± .062	0.00 ± .031	0.0° ± 1°
0.000 ± .031	0.000 ± .015	

Material Thickness: per ASTM Std.

Weld Callouts per AWS

## RELEASE & REVISIONS

INITIAL ECN: **24359**

CURRENT ECN: **25886**

ECN DESCRIPTION:

**UPDATE SUPPLIER PART #**

REVISED BY: **A. ELLISON**

## PURCHASED COMPONENT

REFERENCED SUPPLIER AND/OR MANUFACTURER

**OBERTON ELECTRONICS / ECHOMASTER FLEET SOLUTIONS**

REFERENCED SUPPLIER AND/OR MANUFACTURER PART NUMBER

**8018-6000 / STL40489-3**

COLOR (ONLY LIST IF COLOR SPECIFIC)

COMODITY ITEM (Y/N) (YES = ALL DIMENSIONS AND NOTES ARE REFERENCE)  
(NOTE: DIMENSIONS AND FEATURES MAY VARY FOR A COMODITY ITEM.)

PRINTED DOCUMENT IS UNCONTROLLED

Sheet 1 of 1

## PART / PRODUCT IDENTIFICATION



**ADRIAN STEEL**

ADRIAN STEEL COMPANY  
906 JAMES STREET, ADRIAN, MI 49221

REVISION LEVEL

**B**

MAT'L USED: **PURCHASED**

DESIGNED BY: **A. ELLISON**

DESCRIPTION: **MODULE DOME LED LIGHT**

WEIGHT (Lbs.):

**.50**

SEGMENT CODE: **EAU**

PART NUMBER: **63480**

# PURCHASED COMPONENT KEY FEATURES

## DESCRIPTION OF REQUIREMENTS

DIMENSIONAL REQUIREMENTS (AS SHOWN ON DRAWING)

N/A

LOAD/RATING REQUIREMENT

N/A

MATERIAL REQUIREMENT

N/A

PACKAGING REQUIREMENT

N/A

OTHER REQUIREMENTS

- **Roof Bow #2**
- **(5x) WIRE TIE W/CHRISTMAS TREE**
- **1570mm Length**



**P-HARRB2**

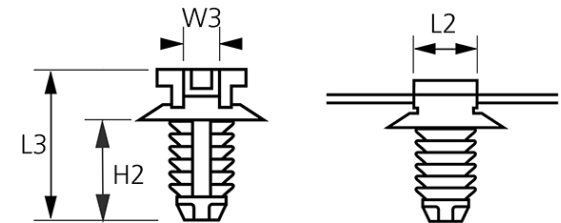

**(5x)**

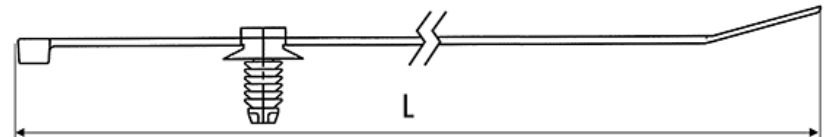

THIS DRAWING IS THE PROPERTY OF ADRIAN STEEL COMPANY AND IS NOT TO BE USED IN ANY MANNER DETRIMENTAL TO THE INTERESTS OF ADRIAN STEEL COMPANY

PRINTED DOCUMENT IS UNCONTROLLED

Sheet 1 of 1

## TOLERANCES & INSPECTION

UNLESS OTHERWISE SPECIFIED  
 ALL BEND ANGLES ARE 90 DEGREES  
 ALL DIMENSIONS ARE IN INCHES.  
 REFERENCE DIMENSIONS (X.XXX)  
 DO NOT REQUIRE INSPECTION

FEATURES	HOLES/SLOTS	ANGLES
0.0 = ± .125	0.0 = ± .062	0° = ± 2°
0.00 = ± .062	0.00 = ± .031	0.0° = ± 1°
0.000 = ± .031	0.000 = ± .015	

Material Thickness: per ASTM Std.  
 Weld Callouts per AWS

## RELEASE & REVISIONS

INITIAL ECN:	<b>24359</b>
CURRENT ECN:	<b>24359</b>
ECN DESCRIPTION:	<b>QE8539 RELEASE MODULAR DOME LIGHTING</b>
REVISED BY:	<b>MJF</b>

## PURCHASED COMPONENT

REFERENCED SUPPLIER AND/OR MANUFACTURER  
**ECHOMASTER FLEET SOLUTIONS**  
 REFERENCED SUPPLIER AND/OR MANUFACTURER PART NUMBER  
**P-HARRB2**  
 COLOR (ONLY LIST IF COLOR SPECIFIC)  
 COMMODITY ITEM (Y/N) (YES = ALL DIMENSIONS AND NOTES ARE REFERENCE)  
 (NOTE: DIMENSIONS AND FEATURES MAY VARY FOR A COMMODITY ITEM.)  
**YES**

## PART / PRODUCT IDENTIFICATION

<b>ADRIAN STEEL</b> ADRIAN STEEL COMPANY 906 JAMES STREET, ADRIAN, MI 49221		REVISION LEVEL <b>A</b>	
MAT'L USED:	<b>PURCHASED</b>	DESIGNED BY:	<b>MJF</b>
DESCRIPTION:		<b>ROOF BOW HARNESS #2</b>	
WEIGHT (Lbs.):	<b>.50</b>	SEGMENT CODE:	<b>EAU</b>
		PART NUMBER: <b>63482</b>	

# PURCHASED COMPONENT KEY FEATURES

## DESCRIPTION OF REQUIREMENTS

DIMENSIONAL REQUIREMENTS (AS SHOWN ON DRAWING)

N/A

LOAD/RATING REQUIREMENT

N/A

MATERIAL REQUIREMENT

N/A

PACKAGING REQUIREMENT

N/A

OTHER REQUIREMENTS

**INCLUDES HARNESS - "P-VTM-HAR"**



THIS DRAWING IS THE PROPERTY OF ADRIAN STEEL COMPANY AND IS NOT TO BE USED IN ANY MANNER DETRIMENTAL TO THE INTERESTS OF ADRIAN STEEL COMPANY

## TOLERANCES & INSPECTION

UNLESS OTHERWISE SPECIFIED

ALL BEND ANGLES ARE 90 DEGREES

ALL DIMENSIONS ARE IN INCHES.

REFERENCE DIMENSIONS (X.XXX)  
DO NOT REQUIRE INSPECTION

FEATURES	HOLES/SLOTS	ANGLES
0.0 = ± .125	0.0 = ± .062	0° = ± 2°
0.00 = ± .062	0.00 = ± .031	0.0° = ± 1°
0.000 = ± .031	0.000 = ± .015	

Material Thickness: per ASTM Std.  
Weld Callouts per AWS

## RELEASE & REVISIONS

INITIAL ECN: **25377**

CURRENT ECN: **25377**

ECN DESCRIPTION:

**RELEASE FOR PRODUCTION**

REVISED BY:

# PURCHASED COMPONENT

REFERENCED SUPPLIER AND/OR MANUFACTURER

**AAMP GLOBAL**

REFERENCED SUPPLIER AND/OR MANUFACTURER PART NUMBER

**VTM OR 65786**

COLOR (ONLY LIST IF COLOR SPECIFIC)

COMODITY ITEM (Y/N) (YES = ALL DIMENSIONS AND NOTES ARE REFERENCE)  
(NOTE: DIMENSIONS AND FEATURES MAY VARY FOR A COMODITY ITEM.)

**NO**

PRINTED DOCUMENT IS UNCONTROLLED

Sheet 1 of 1

## PART / PRODUCT IDENTIFICATION



**ADRIAN STEEL®**

ADRIAN STEEL COMPANY  
906 JAMES STREET, ADRIAN, MI 49221

REVISION LEVEL

**A**

MAT'L USED: **PURCHASED**

DESIGNED BY: **E.BURKE**

DESCRIPTION: **VOLTAGE TIMER MODULE**

WEIGHT (Lbs.): **0.2**

SEGMENT CODE: **ELE**

PART NUMBER: **65786**

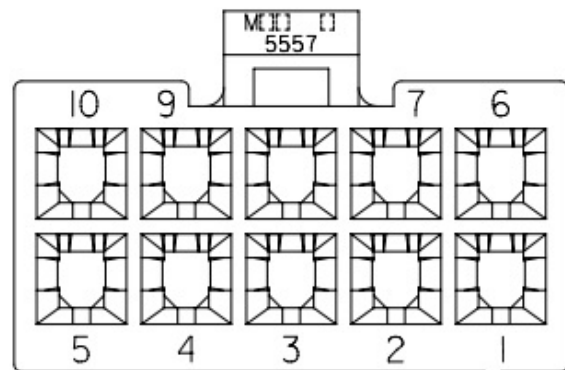

Rear View of Connector - Wire Side of Connector

From	To	Color	Gauge
C1.1	Fuse_Holder.1	Red	16 AWG
C1.2	Input1.A	Red	16 AWG
C1.3	Output.A	Red	16 AWG
C1.4	Input2.A	Red	16 AWG
C1.5	SW1_Input.1	White/Black	20 AWG
C1.5	SW2_Input.1	White/Black	20 AWG
C1.6	GND	Black	16 AWG
C1.7	Input1.B	Black	16 AWG
C1.8	Output.B	Black	16 AWG
C1.9	Input2.B	Black	16 AWG
C1.10	SW1_Input.2	Black	20 AWG
C1.10	SW2_Input.2	Black	20 AWG

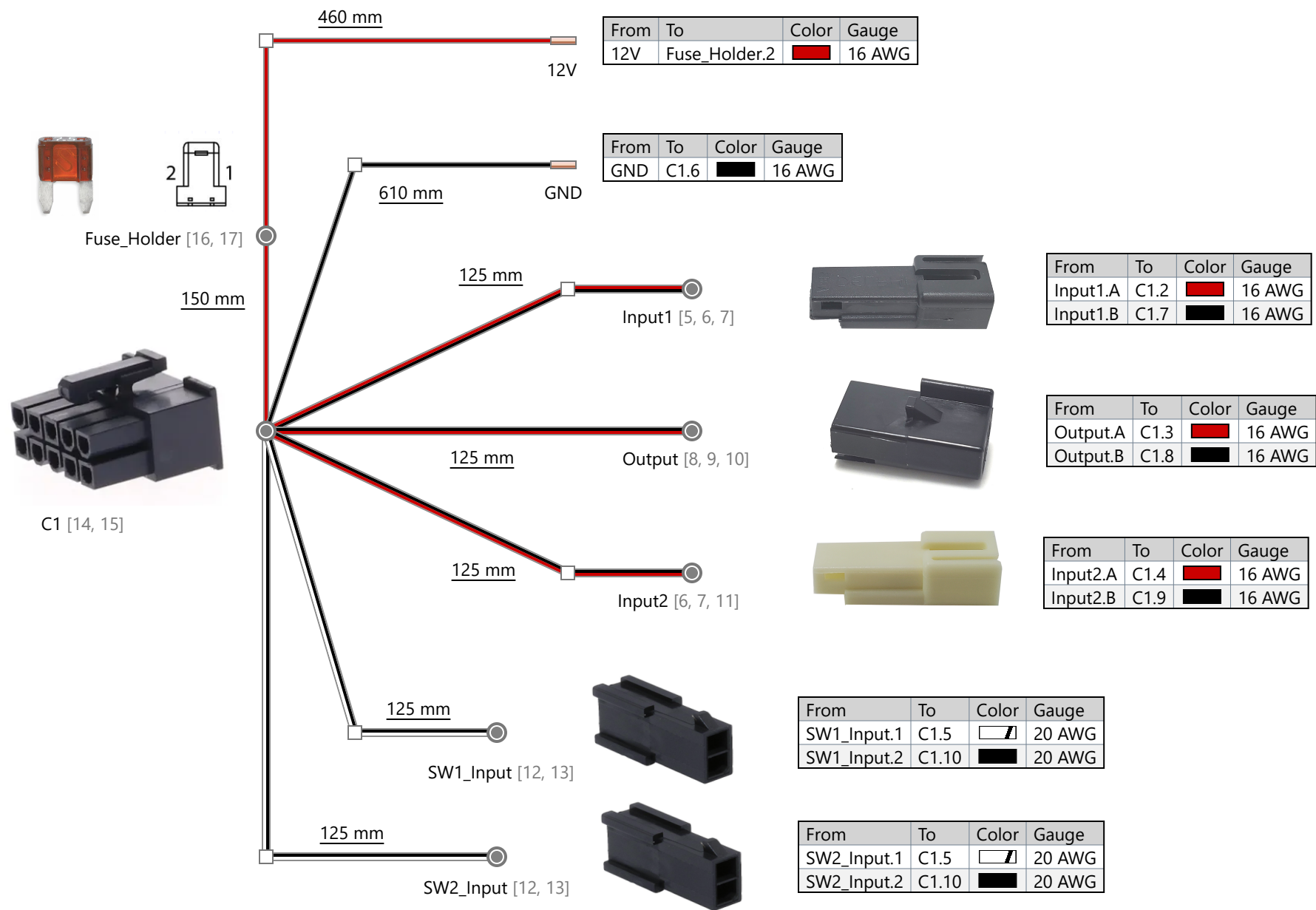

Input.1 for each switch is the ground signal that will be fed back to the timer module for activation

Input.2 for each switch is a ground that will be provided by the timer module

Revisions			
Rev.	Date	Author	Description
v1	03/26/21	Bennet Fisher	Initial Drawing
v2	7/1/2021	Bennet Fisher	Revised pin 4 and 9 connections; spliced switch inputs
v3	7/22/2021	Bennet Fisher	Changed second dome connector
v4	11/8/2021	Bennet Fisher	Eliminated White/Black and Black wire splices; Corrected contacts for C1.4, C1.5, C1.9, and C1.10

UNLESS OTHERWISE SPECIFIED			
DIMENSIONS ARE IN MILLIMETERS (INCHES)			
TOLERANCES: ±5MM			
Designated By	Name	Date	
	Bennet Fisher	3/26/21	
<b>PROPRIETARY AND CONFIDENTIAL</b>			
THE INFORMATION CONTAINED IN THIS DRAWING IS THE SOLE PROPERTY OF AAMP GLOBAL. ANY REPRODUCTION IN PART OR AS A WHOLE WITHOUT THE WRITTEN PERMISSION OF AAMP GLOBAL IS PROHIBITED.			
Engineering Approval	----	----	
Manufacturing Approval	----	----	
Revision Approval	----	----	
Quality Assurance	----	----	
Part Number: P-VTM-HAR_			Revision: ----
Description: Timer Module Harness			Sheet: 1 of 1





## VTM

## Voltage Timer Module

### INSTALLATION MANUAL





## Thank you for purchasing the **VTM**



### **WHAT'S INCLUDED:**

- Voltage Timer Module
- Voltage Timer Module Harness
- Screws

### **COMPATIBLE ACCESSORIES:**

- Vehicle-specific harness (P-VTM-xxx)
- Switch harness (VTM-SWx)
- High current harness (VTM-RLY)

### **FEATURES:**

- Selectable timer durations - 60, 90, 120, and 150 minutes
- Low voltage shut off at 11.8V
- Timer and Low Voltage sense work independently of each other
- Inputs for 2 momentary switches
- 7.5A max current output





## OPERATING INSTRUCTIONS:

DIP SWITCH 1 UP/DOWN	DIP SWITCH 2 UP/DOWN	DIP SWITCH 3	DIP SWITCH 4	Timer Duration (Minutes)
Voltage Sense ON/OFF	Timer ON/OFF	UP	DOWN	60
		UP	UP	90
		DOWN	UP	120
		DOWN	DOWN	150

If Voltage Sense is turned ON, low voltage shut down will occur when voltage input drops below 11.8V. To eliminate false triggers, there is a 20 second delay before shut down.

If Voltage Sense is turned OFF, input voltage level will not be monitored.

**NOTE:** Voltage Sense takes precedence over Timer. Voltage Sense is only active when the Switch Inputs are activated. Voltage Sense does not monitor VTM Trigger Input.

If Timer is ON and a switch input is activated, output voltage will be provided for specified timer duration.

While output voltage is active, pressing a switch will disable the output voltage. If pressed once again, output voltage will be re-activated and reset the timer.

Trigger Input	Switch Input	Output	Voltage Sense (ON)	Timer (ON)
Active	N/A	ON	N/A	N/A
Deactivated	N/A	OFF	N/A	N/A
Not Active	Activated (Pressed)	ON	Monitoring Input Voltage	Timer starts
Not Active	Activated (Pressed)	OFF	N/A	Timer off
Not Active	Activated (Pressed)	ON	Monitoring Input Voltage	Timer resets

If VTM Trigger Input to the VTM module is active, its function takes precedence.



## WIRING DIAGRAMS:

### VTM Harness

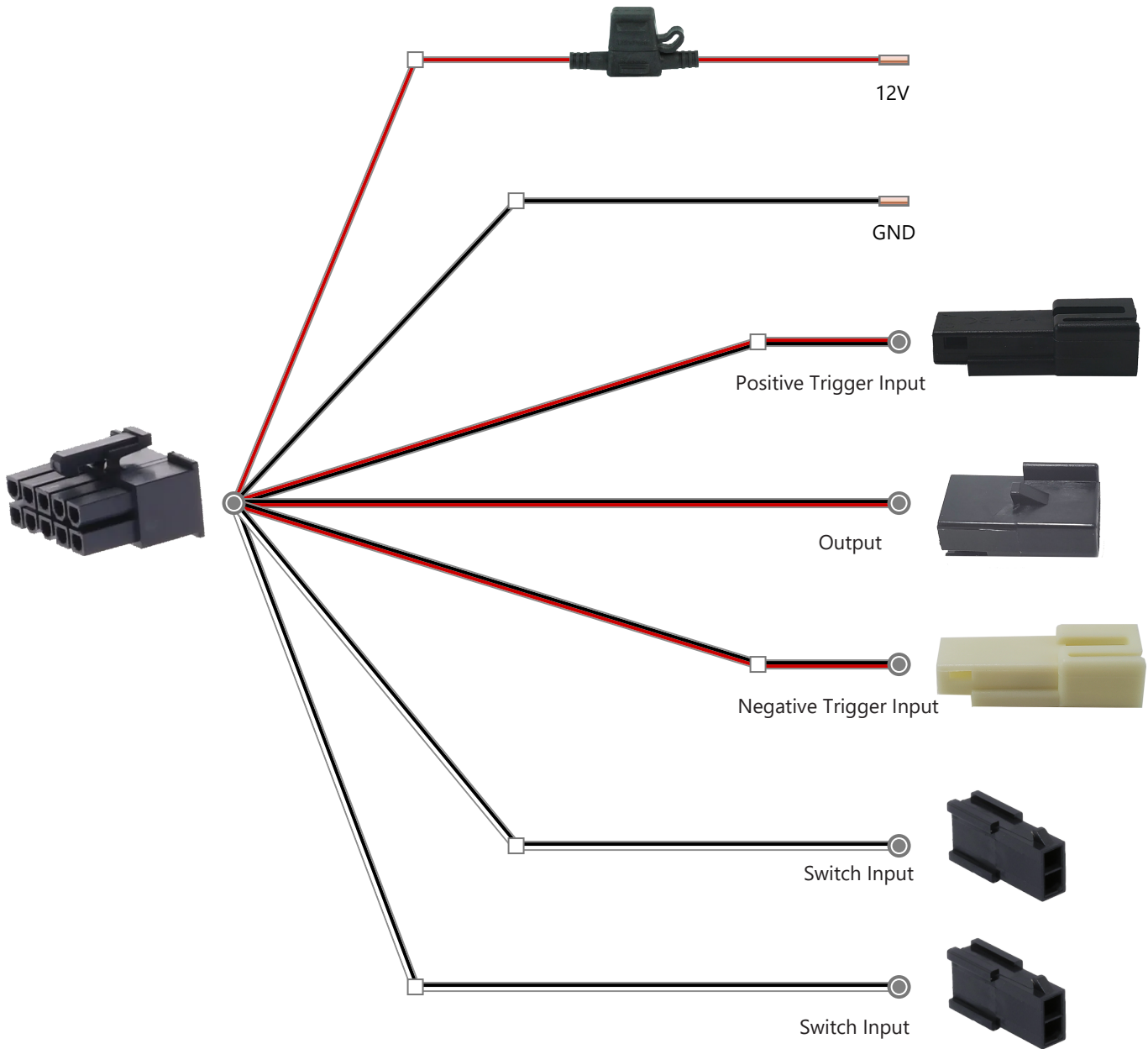

## VTM-RLY (Optional Harness)

For larger current demands, use the optional VTM-RLY and connect to power and ground, along with the VTM harness. VTM-RLY supports up to 15A.

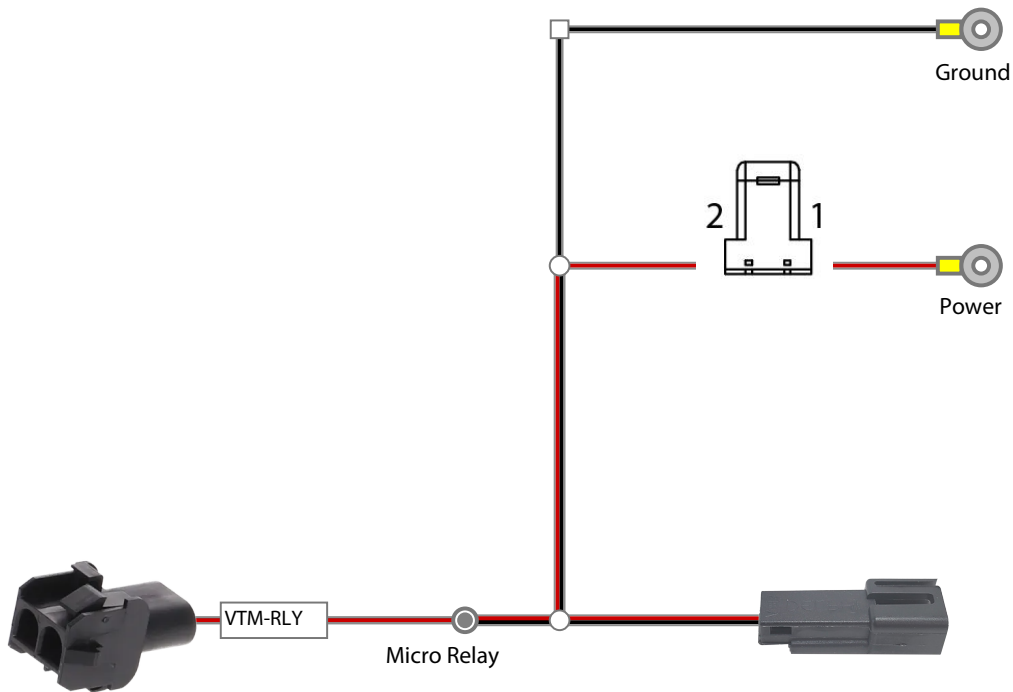

VTM-RLY Output connects to the P-VTMxxx harness for vehicle lighting

VTM-RLY Input connects to the output from the VTM harness





Phone – 866-931-8021 (option 3)

E-Mail – [support@echomasterfleetsolutions.com](mailto:support@echomasterfleetsolutions.com)



**EchoMaster Fleet Solutions is a Power Brand of AAMP Global**

[EchoMasterfleetsolutions.com](http://EchoMasterfleetsolutions.com)

# PURCHASED COMPONENT KEY FEATURES

## DESCRIPTION OF REQUIREMENTS

DIMENSIONAL REQUIREMENTS (AS SHOWN ON DRAWING)

N/A

LOAD/RATING REQUIREMENT

N/A

MATERIAL REQUIREMENT

N/A

PACKAGING REQUIREMENT

N/A

OTHER REQUIREMENTS



THIS DRAWING IS THE PROPERTY OF ADRIAN STEEL COMPANY AND IS NOT TO BE USED IN ANY MANNER DETRIMENTAL TO THE INTERESTS OF ADRIAN STEEL COMPANY

## TOLERANCES & INSPECTION

UNLESS OTHERWISE SPECIFIED

ALL BEND ANGLES ARE 90 DEGREES

ALL DIMENSIONS ARE IN INCHES.

REFERENCE DIMENSIONS (X.XXX)  
DO NOT REQUIRE INSPECTION

FEATURES	HOLES/SLOTS	ANGLES
0.0 = ± .125	0.0 = ± .062	0° = ± 2°
0.00 = ± .062	0.00 = ± .031	0.0° = ± 1°
0.000 = ± .031	0.000 = ± .015	

Material Thickness: per ASTM Std.  
Weld Callouts per AWS

## RELEASE & REVISIONS

INITIAL ECN: **25377**

CURRENT ECN: **25377**

ECN DESCRIPTION:

**RELEASE FOR PRODUCTION**

REVISED BY:

# PURCHASED COMPONENT

REFERENCED SUPPLIER AND/OR MANUFACTURER

**AAMP GLOBAL**

REFERENCED SUPPLIER AND/OR MANUFACTURER PART NUMBER

**VTM-SW2 OR 65788**

COLOR (ONLY LIST IF COLOR SPECIFIC)

COMODITY ITEM (Y/N) (YES = ALL DIMENSIONS AND NOTES ARE REFERENCE)  
(NOTE: DIMENSIONS AND FEATURES MAY VARY FOR A COMODITY ITEM.)

**NO**

PRINTED DOCUMENT IS UNCONTROLLED

Sheet 1 of 1

## PART / PRODUCT IDENTIFICATION



**ADRIAN STEEL**

ADRIAN STEEL COMPANY  
906 JAMES STREET, ADRIAN, MI 49221

REVISION LEVEL

**A**

MAT'L USED: **PURCHASED**

DESIGNED BY: **E.BURKE**



DESCRIPTION: **SWITCH 2 HARNESS FOR VTM**

WEIGHT (Lbs.): **0.2**

SEGMENT CODE: **ELE**

PART NUMBER: **65788**

Coverings	
Id	Assembly
[6]	

From	To	Color	Gauge
C1.1	QC1		20 AWG
C1.2	QC2		20 AWG

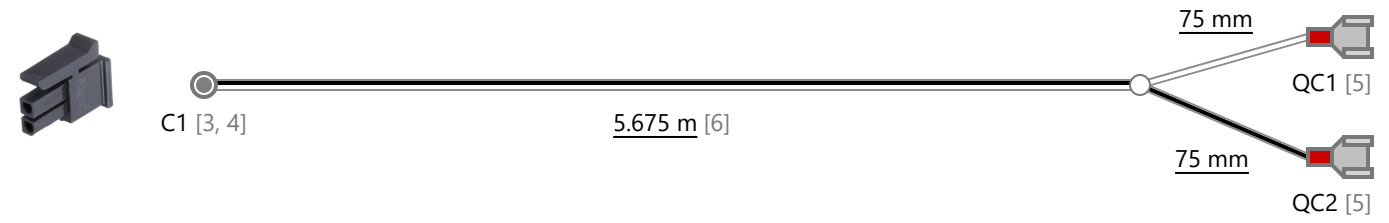

From	To	Color	Gauge
QC1	C1.1		20 AWG

From	To	Color	Gauge
QC2	C1.2		20 AWG



UNLESS OTHERWISE SPECIFIED DIMENSIONS ARE IN MILLIMETERS [INCHES] TOLERANCES: ±5MM  <b>PROPRIETARY AND CONFIDENTIAL</b>  THE INFORMATION CONTAINED IN THIS DRAWING IS THE SOLE PROPERTY OF AAMP GLOBAL. ANY REPRODUCTION IN PART OR AS A WHOLE WITHOUT THE WRITTEN PERMISSION OF AAMP GLOBAL IS PROHIBITED.		Name	Date	 — ADVANCING VEHICLE TECHNOLOGY —
	Designed By	Bennet Fisher	6/10/2021	
	Engineering Approval			
	Manufacturing Approval			
	Revision Approval			
Quality Assurance				
	Part Number: VTM-SW2		Revision: 1	
	Description: 5.675 Meter Switch Harness		Sheet: ----	

Revisions			
Rev.	Date	Author	Description
1	6/10/21	Bennet Fisher	Initial Drawing

# PURCHASED COMPONENT KEY FEATURES

## DESCRIPTION OF REQUIREMENTS

DIMENSIONAL REQUIREMENTS (AS SHOWN ON DRAWING)

N/A

LOAD/RATING REQUIREMENT

N/A

MATERIAL REQUIREMENT

N/A

PACKAGING REQUIREMENT

N/A

OTHER REQUIREMENTS

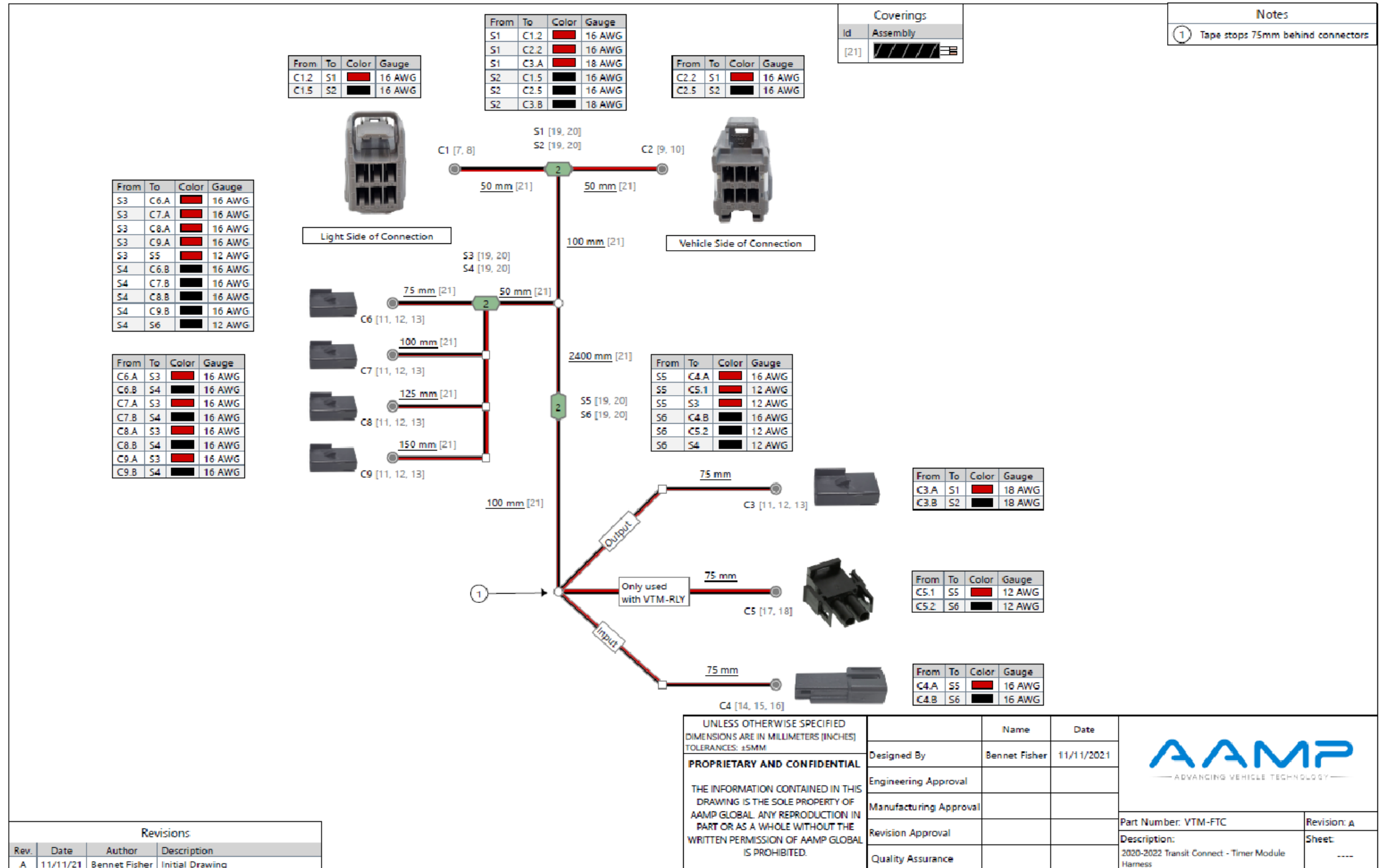

THIS DRAWING IS THE PROPERTY OF ADRIAN STEEL COMPANY AND IS NOT TO BE USED IN ANY MANNER DETRIMENTAL TO THE INTERESTS OF ADRIAN STEEL COMPANY

PRINTED DOCUMENT IS UNCONTROLLED

Sheet 1 of 1

## TOLERANCES & INSPECTION

## RELEASE & REVISIONS

UNLESS OTHERWISE SPECIFIED  
ALL BEND ANGLES ARE 90 DEGREES  
ALL DIMENSIONS ARE IN INCHES.  
REFERENCE DIMENSIONS (X.XXX)  
DO NOT REQUIRE INSPECTION

FEATURES	HOLES/SLOTS	ANGLES
0.0 = ± .125	0.0 = ± .062	0° = ± 2°
0.00 = ± .062	0.00 = ± .031	0.0° = ± 1°
0.000 = ± .031	0.000 = ± .015	

Material Thickness: per ASTM Std.  
Weld Callouts per AWS

INITIAL ECN: **25377**  
CURRENT ECN: **25377**  
ECN DESCRIPTION:  
**RELEASE FOR PRODUCTION**  
REVISED BY: **EMB**

# PURCHASED COMPONENT

REFERENCED SUPPLIER AND/OR MANUFACTURER  
**AAMP GLOBAL**

REFERENCED SUPPLIER AND/OR MANUFACTURER PART NUMBER  
**VTM-FTC OR 65795**

COLOR (ONLY LIST IF COLOR SPECIFIC)  
**NO**

COMODITY ITEM (Y/N) (YES = ALL DIMENSIONS AND NOTES ARE REFERENCE)  
(NOTE: DIMENSIONS AND FEATURES MAY VARY FOR A COMODITY ITEM.)  
**NO**

## PART / PRODUCT IDENTIFICATION

	<b>ADRIAN STEEL</b>	ADRIAN STEEL COMPANY 906 JAMES STREET, ADRIAN, MI 49221	REVISION LEVEL <b>A</b>
	MAT'L USED: <b>PURCHASED</b>	DESIGNED BY: <b>E.BURKE</b>	
DESCRIPTION: <b>HARN, POWER VTM FTC</b>			
WEIGHT (Lbs.): <b>0.2</b>	SEGMENT CODE: <b>ELE</b>	PART NUMBER: <b>65795</b>	

Notes

- ① Tape stops 75mm behind connectors

Coverings	
Id	Assembly
[21]	

From	To	Color	Gauge
C1.2	S1	Red	16 AWG
C1.5	S2	Black	16 AWG

From	To	Color	Gauge
S1	C1.2	Red	16 AWG
S1	C2.2	Red	16 AWG
S1	C3.A	Red	18 AWG
S2	C1.5	Black	16 AWG
S2	C2.5	Black	16 AWG
S2	C3.B	Black	18 AWG

From	To	Color	Gauge
C2.2	S1	Red	16 AWG
C2.5	S2	Black	16 AWG

From	To	Color	Gauge
S3	C6.A	Red	16 AWG
S3	C7.A	Red	16 AWG
S3	C8.A	Red	16 AWG
S3	C9.A	Red	16 AWG
S3	S5	Red	12 AWG
S4	C6.B	Black	16 AWG
S4	C7.B	Black	16 AWG
S4	C8.B	Black	16 AWG
S4	C9.B	Black	16 AWG
S4	S6	Black	12 AWG

From	To	Color	Gauge
C6.A	S3	Red	16 AWG
C6.B	S4	Black	16 AWG
C7.A	S3	Red	16 AWG
C7.B	S4	Black	16 AWG
C8.A	S3	Red	16 AWG
C8.B	S4	Black	16 AWG
C9.A	S3	Red	16 AWG
C9.B	S4	Black	16 AWG

From	To	Color	Gauge
S5	C4.A	Red	16 AWG
S5	C5.1	Red	12 AWG
S5	S3	Red	12 AWG
S6	C4.B	Black	16 AWG
S6	C5.2	Black	12 AWG
S6	S4	Black	12 AWG

From	To	Color	Gauge
C3.A	S1	Red	18 AWG
C3.B	S2	Black	18 AWG

From	To	Color	Gauge
C5.1	S5	Red	12 AWG
C5.2	S6	Black	12 AWG

From	To	Color	Gauge
C4.A	S5	Red	16 AWG
C4.B	S6	Black	16 AWG

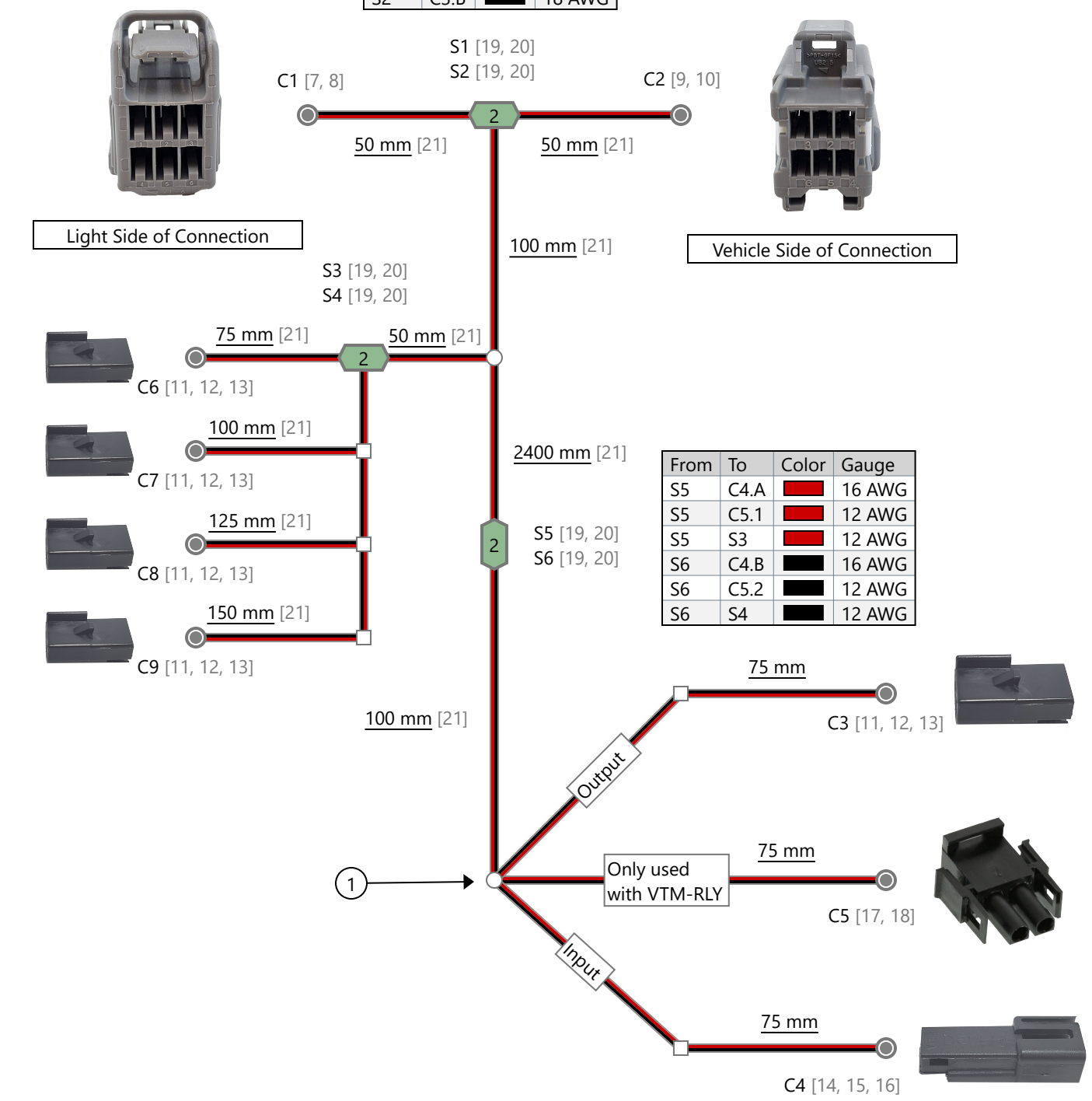

Revisions			
Rev.	Date	Author	Description
A	11/11/21	Bennet Fisher	Initial Drawing

UNLESS OTHERWISE SPECIFIED  
DIMENSIONS ARE IN MILLIMETERS [INCHES]  
TOLERANCES: ±5MM

**PROPRIETARY AND CONFIDENTIAL**

THE INFORMATION CONTAINED IN THIS DRAWING IS THE SOLE PROPERTY OF AAMP GLOBAL. ANY REPRODUCTION IN PART OR AS A WHOLE WITHOUT THE WRITTEN PERMISSION OF AAMP GLOBAL IS PROHIBITED.

	Name	Date
Designed By	Bennet Fisher	11/11/2021
Engineering Approval		
Manufacturing Approval		
Revision Approval		
Quality Assurance		



— ADVANCING VEHICLE TECHNOLOGY —

Part Number: VTM-FTC	Revision: A
Description: 2020-2022 Transit Connect - Timer Module Harness	Sheet: ----

# PURCHASED COMPONENT KEY FEATURES

## DESCRIPTION OF REQUIREMENTS

DIMENSIONAL REQUIREMENTS (AS SHOWN ON DRAWING)

N/A

LOAD/RATING REQUIREMENT

N/A

MATERIAL REQUIREMENT

N/A

PACKAGING REQUIREMENT

N/A

OTHER REQUIREMENTS

**RING TERMINAL:  
16-14GA  
1/4" STUD SIZE  
BLUE  
TIN PLATED COPPER**



THIS DRAWING IS THE PROPERTY OF ADRIAN STEEL COMPANY AND IS NOT TO BE USED IN ANY MANNER DETRIMENTAL TO THE INTERESTS OF ADRIAN STEEL COMPANY

## TOLERANCES & INSPECTION

*UNLESS OTHERWISE SPECIFIED*

ALL BEND ANGLES ARE 90 DEGREES

ALL DIMENSIONS ARE IN INCHES.

REFERENCE DIMENSIONS (X.XXX)  
DO NOT REQUIRE INSPECTION

FEATURES	HOLES/SLOTS	ANGLES
0.0 = ± .125	0.0 = ± .062	0° = ± 2°
0.00 = ± .062	0.00 = ± .031	0.0° = ± 1°
0.000 = ± .031	0.000 = ± .015	

Material Thickness: per ASTM Std.  
Weld Callouts per AWS

## RELEASE & REVISIONS

INITIAL ECN: **25975**

CURRENT ECN: **25975**

ECN DESCRIPTION:

**RELEASE TO PRODUCTION**

REVISED BY: **N/A**

# PURCHASED COMPONENT

REFERENCED SUPPLIER AND/OR MANUFACTURER

**WAYTEK**

REFERENCED SUPPLIER AND/OR MANUFACTURER PART NUMBER

**37393**

COLOR (ONLY LIST IF COLOR SPECIFIC)

**BLUE**

COMODITY ITEM (Y/N) (YES = ALL DIMENSIONS AND NOTES ARE REFERENCE)  
(NOTE: DIMENSIONS AND FEATURES MAY VARY FOR A COMODITY ITEM.)

**NO**

PRINTED DOCUMENT IS UNCONTROLLED

Sheet 1 of 1

## PART / PRODUCT IDENTIFICATION



**ADRIAN STEEL®**

ADRIAN STEEL COMPANY  
906 JAMES STREET, ADRIAN, MI 49221

REVISION LEVEL

**A**

MAT'L USED: **PURCHASED**

DESIGNED BY: **EMB**

DESCRIPTION: **WIRE TERM 1/4"RING 14-16G**

WEIGHT (Lbs.): **0.01**

SEGMENT CODE: **ELE**

PART NUMBER: **69511**

# PURCHASED COMPONENT KEY FEATURES

## DESCRIPTION OF REQUIREMENTS

DIMENSIONAL REQUIREMENTS (AS SHOWN ON DRAWING)

**MICRO2**

LOAD/RATING REQUIREMENT

**5 AMP**

MATERIAL REQUIREMENT

**N/A**

PACKAGING REQUIREMENT

**N/A**

OTHER REQUIREMENTS

**(1) 7.5 AMP FUSE MICRO 2 STYLE**



THIS DRAWING IS THE PROPERTY OF ADRIAN STEEL COMPANY AND IS NOT TO BE USED IN ANY MANNER DETRIMENTAL TO THE INTERESTS OF ADRIAN STEEL COMPANY

## TOLERANCES & INSPECTION

*UNLESS OTHERWISE SPECIFIED*

ALL BEND ANGLES ARE 90 DEGREES

ALL DIMENSIONS ARE IN INCHES.

REFERENCE DIMENSIONS (X.XXX)  
DO NOT REQUIRE INSPECTION

FEATURES	HOLES/SLOTS	ANGLES
0.0 = ± .125	0.0 = ± .062	0° = ± 2°
0.00 = ± .062	0.00 = ± .031	0.0° = ± 1°
0.000 = ± .031	0.000 = ± .015	

Material Thickness: per ASTM Std.  
Weld Callouts per AWS

## RELEASE & REVISIONS

INITIAL ECN: **26015**

CURRENT ECN: **26015**

ECN DESCRIPTION:

**RELEASE TO PRODUCTION.**

REVISED BY: **N/A**

# PURCHASED COMPONENT

REFERENCED SUPPLIER AND/OR MANUFACTURER

**WAYTEK**

REFERENCED SUPPLIER AND/OR MANUFACTURER PART NUMBER

**46117**

COLOR (ONLY LIST IF COLOR SPECIFIC)

COMODITY ITEM (Y/N) (YES = ALL DIMENSIONS AND NOTES ARE REFERENCE)  
(NOTE: DIMENSIONS AND FEATURES MAY VARY FOR A COMODITY ITEM.)

**YES**

PRINTED DOCUMENT IS UNCONTROLLED

Sheet 1 of 1

## PART / PRODUCT IDENTIFICATION



**ADRIAN STEEL®**

ADRIAN STEEL COMPANY  
906 JAMES STREET, ADRIAN, MI 49221

REVISION LEVEL

**A**

MAT'L USED:

DESIGNED BY: **E.Burke**

DESCRIPTION:

**FUSE, MICRO2 7.5 AMP**

WEIGHT (Lbs.): **.10**

SEGMENT CODE: **ELE**

PART NUMBER: **69821**