

Introduction / Comments:

Install Instructions For Exterior Plug & Play Lights For Transit

Note:

Read all instructions prior to installation. Review the Adrian Steel **GENERAL PRECAUTIONS PAGES (56638)** before attempting installation. Only personnel familiar with using electrical best practices should perform this install. Reference **ELECTRICAL BEST PRACTICES MANUAL (54479)** before attempting installation.

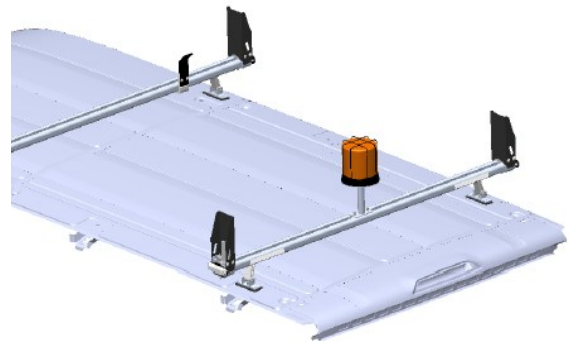

Installation Instructions For Exterior Plug And Play Lights For Transit

Table of Contents:

Torque requirements.....	2
Best Practice for Routing through Firewall.....	3
Introduction Statement.....	4
Overall Harness Diagram.....	4
Tools needed.....	4
Harnesses/Components Needed (If Applicable).....	5
Component Placements.....	6
Overall Harness Routing.....	7
Beginning Install.....	8
Strobe Installation Instructions.....	10
Beacon/Lightbar Installation Instructions.....	14

*****TORQUE*****
Torque all strobe fasteners to 10 in-lbs.
DO NOT OVER TIGHTEN

DO NOT MOUNT ON A CURVED SURFACE

Best Practices to Follow when Routing Through Firewall:

- Create a drip loop with the harness being routed through the firewall as shown so that the water does not flow into the grommet.
- Make sure that the proper grommet for the hole being routed through is used so that there are no openings for water to get through.
- Use silicone after routing and apply around the grommet and wire to seal it. Make sure to let the silicone dry for 30 minutes to an hour.

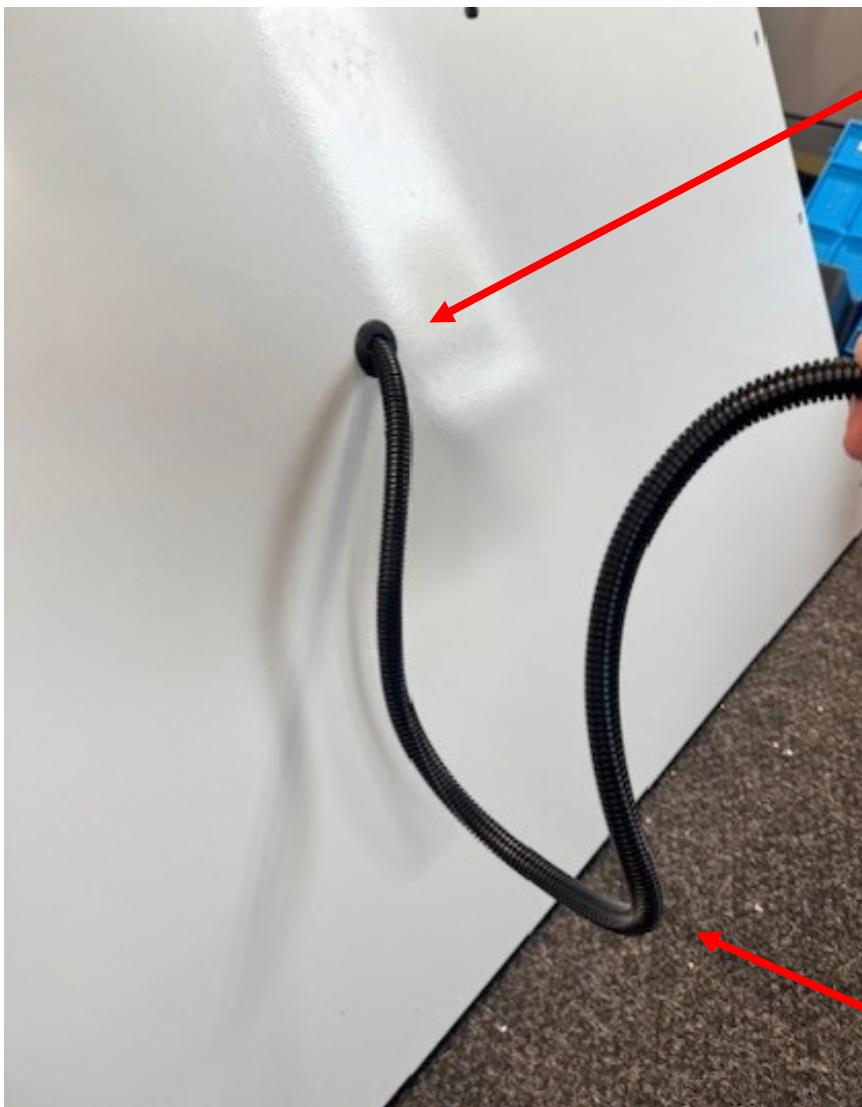

Apply silicone around the grommet and wire loom so that it is completely sealed.

Drip loop created so water runs off of loom and not into the cab of the vehicle.

****Please read statement below before moving forward****

Before installation, disconnect the OEM negative battery cable.

These plug and play kits are completely modular and can be configured in many different ways. Placement of lights will be determined by sales order drawings/customer ask. Therefore, these instructions are for the most standard configurations, and for reference only.

Please reference the order drawing and spec sheet to see what components are going to be installed on this particular upfit.

These installation instructions are for most cases and for reference. Not all installs will have strobes, beacons, and lightbars. Reference the instructions for only what you are installing.

Overall Harness Diagram

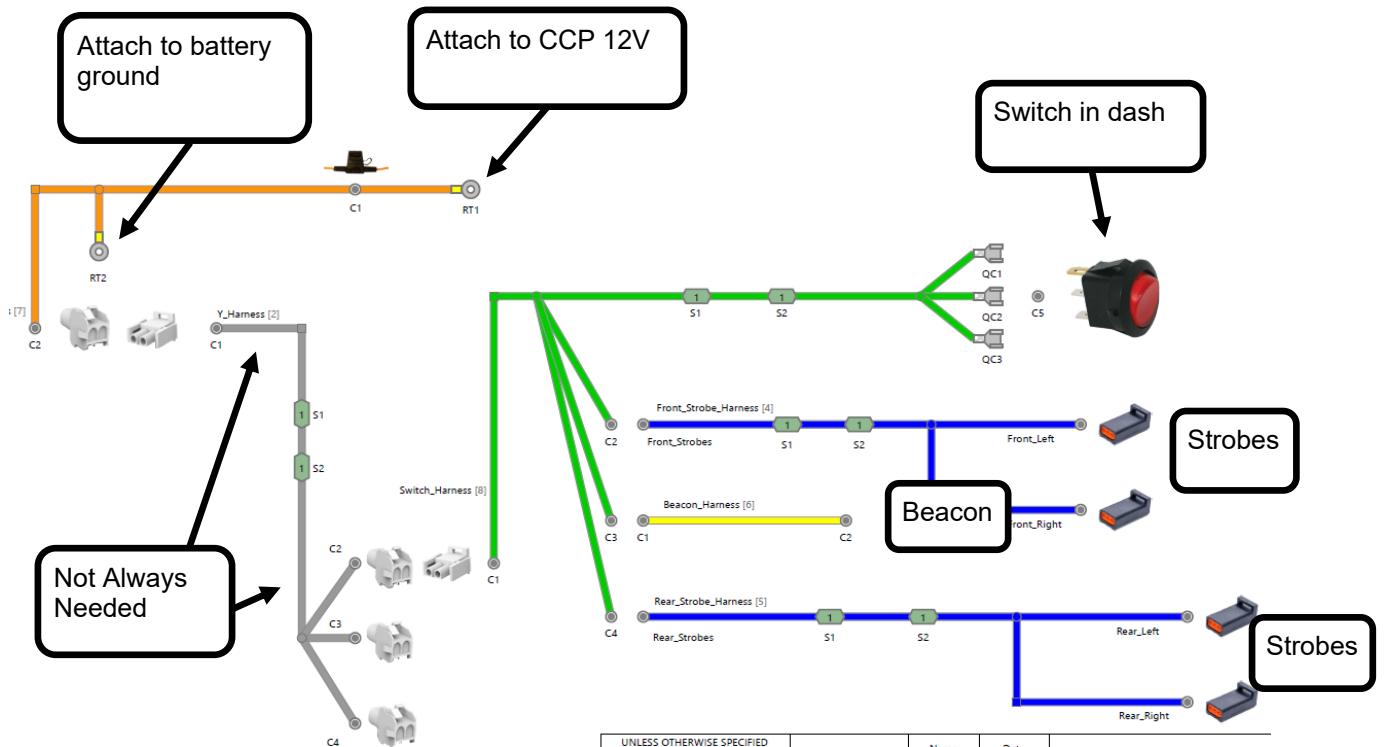

Tools required:

13mm and 10mm socket

Phillips bit, 1/2" drill bit and 5/16" step drill bit

Power drill and impact

Torque wrench

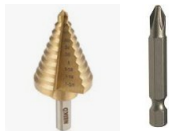

Components

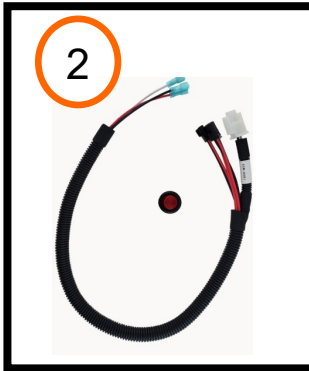
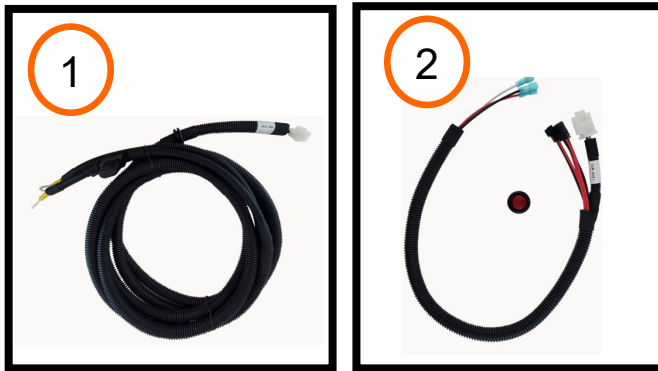

	Part Number	Description
1	67092	Power Harness #1
2	67098	Switch Harness #2
3	67102	Front Strobe Harness #2 (If Applicable)
4	67109	Rear Strobe Harness #4 (If Applicable)
5	67114 or 67115	Beacon/Lightbar Harness #4 or 5 (If Applicable)
6	67686 or 67687	Strobes (If Applicable)
7	64531	Strobe Brackets (If applicable)
8	67689 or 67690	Beacons (If Applicable)
9	51545	Beacon Ladder rack Mount (If Applicable)
10	67691 or 67692 or 96118 or 67693	Lightbars (If Applicable)



The purpose of plug and play lighting is to be completely modular. Due to this feature, refer to the order drawing for all exact lighting placements. These installation instructions are for most cases and for reference. Not all installs will have strobes, beacons, and lightbars. Reference the instructions for only what you are installing.

Harness pictures are for reference only.

Placements

Switch placement: Under Steering Wheel



Front Strobes: Outside Of Grill



*****TORQUE STROBES TO 10-IN-LB'S
MAXIMUM*****

Beacon or Lightbar: On Roof (Or ladder rack)



Rear Strobes: Above Rear Door



Routing Overview

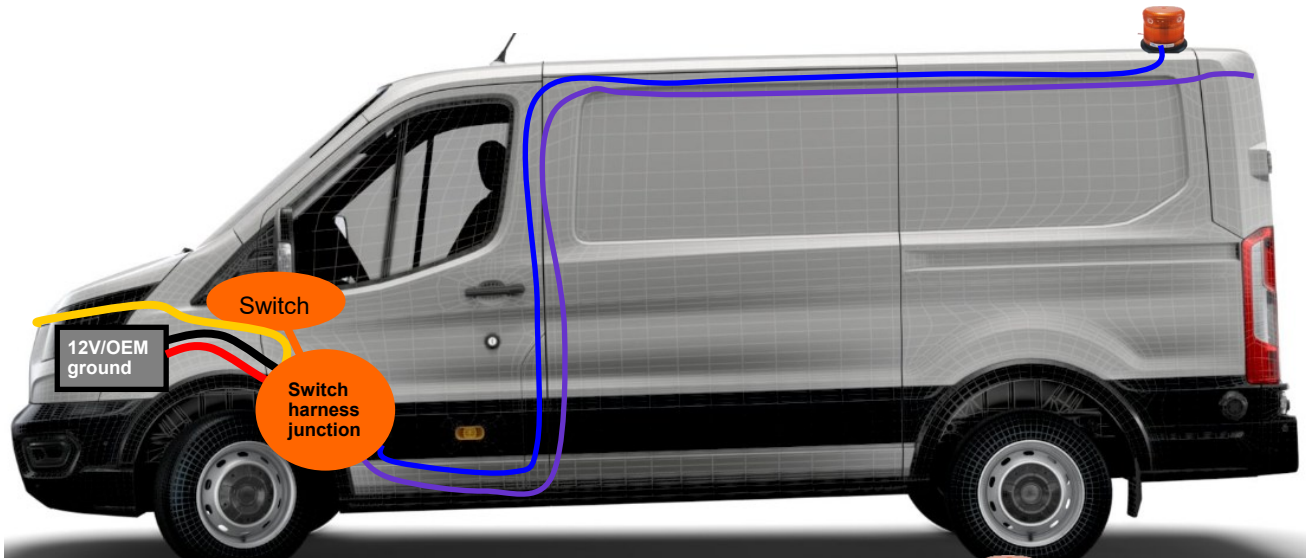
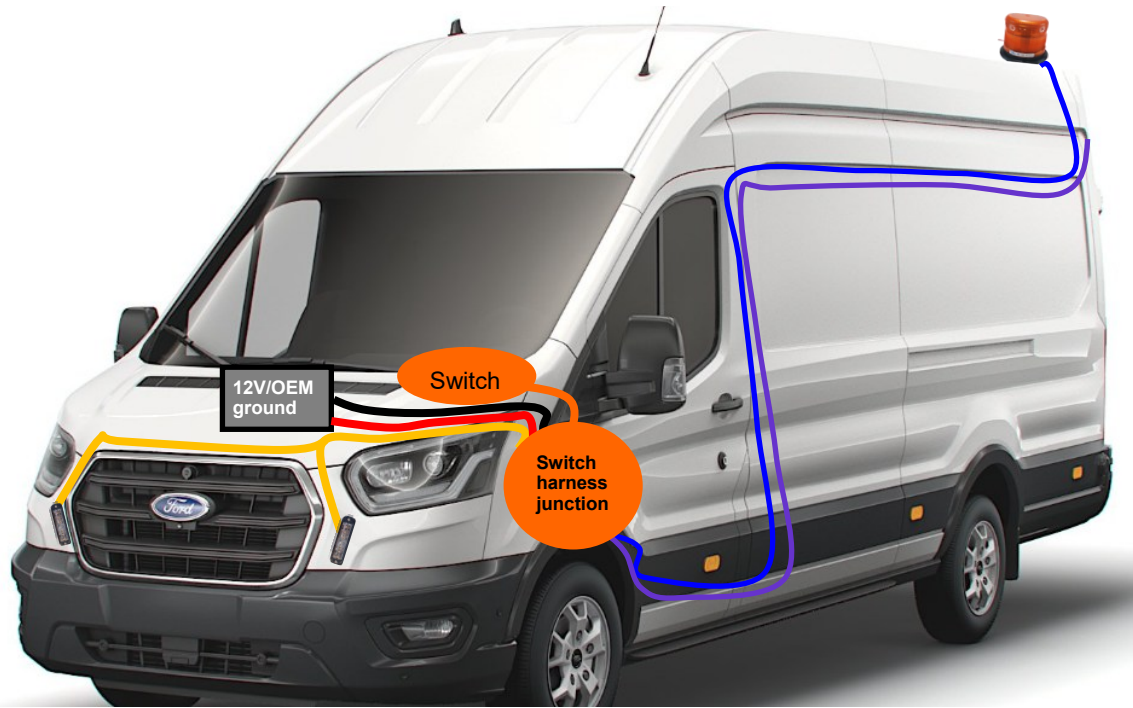

Color	Key - Items
Yellow	Strobes - Front strobe harness
Red/Black	Power harness: Battery to kick panel
Orange	Switch harness: Switch in dash
Blue	Beacon harness: Switch to beacon
Purple	Strobes - Rear strobe harness



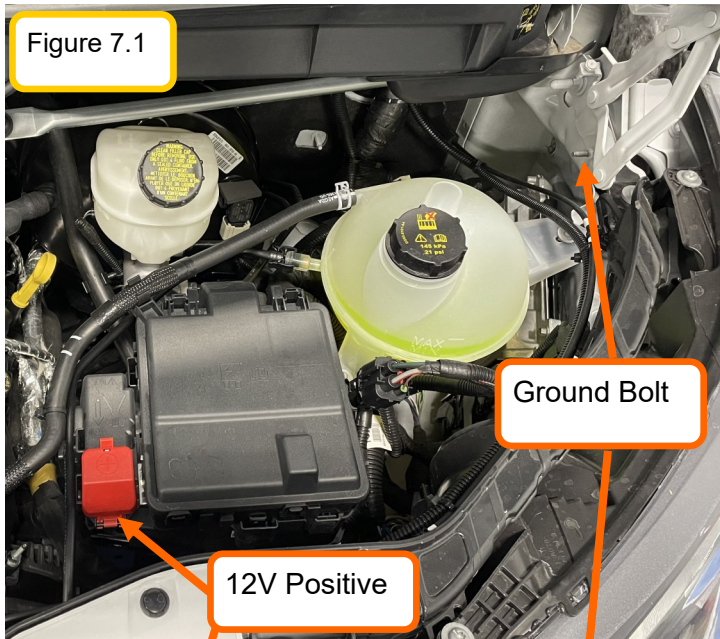

Step 1: Locate the power harness #67092.

Remove the fuse from the inline fuse holder until the end of the install

Under the hood:

Locate the 12V Power point on the fuse block and the OEM ground bolt on the driver's side body frame. Figure 7.1.

Step 2:

Attach the red wire with the ring terminal to the 12V positive post. Figure 7.2.

Attach the black wire with the ring terminal to the OEM ground post. Figure 7.3.

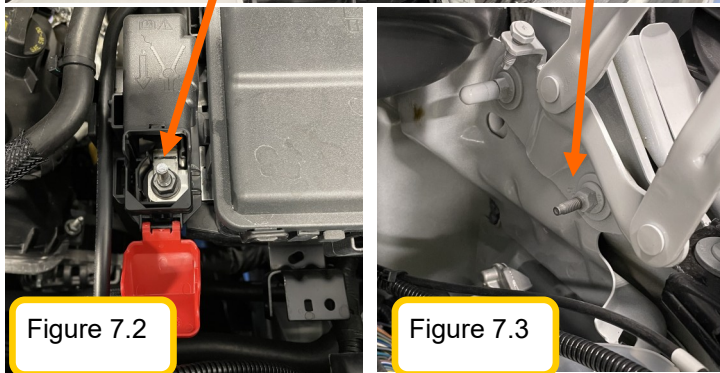

Route the white connector end towards the cab and locate the OEM grommet (to the cab). Figure 7.4. Secure with zip ties.

Step 3:

Cut/drill a hole in the grommet to route the power harness through.

****If you are installing strobes on this install route the strobe harness interior connector in through the grommet at this time as well. Refer to page 11 for routing strobe instructions. Figure 7.5 for connector reference.**

Silicone the grommet holes/wiring once all harnesses have been routed through. Make sure to have a drip loop.

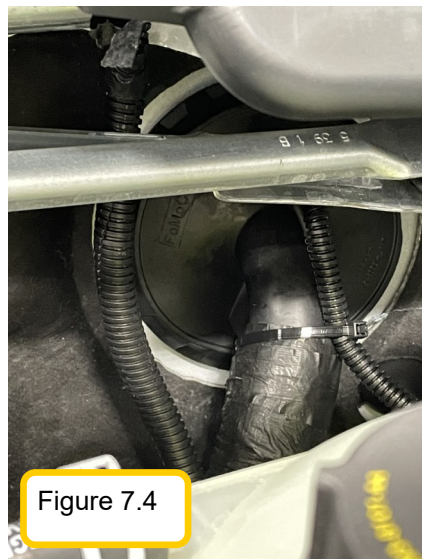

Reference Pg. 3 for how to route through the firewall.

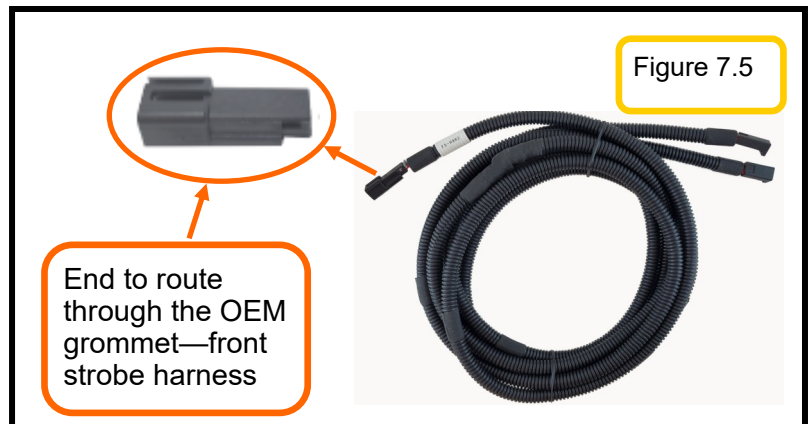

Power harness

Switch Harness



Figure 8.1

Figure 8.2

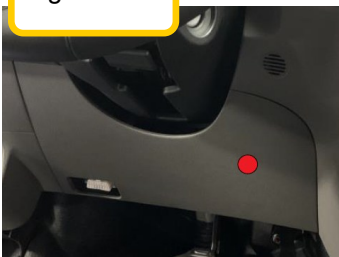

Step 4: Locate the switch harness #67098

Connect the switch harness connector to the power harness in the kick panel area.

Remove the knee bolster beneath the steering wheel. Figure 8.1 and 8.2.

Drill a hole in the trim panel for the switch: The button location is 3.25" from the right side edge and 4" above the bottom edge of the knee bolster panel.

A hole diameter of 3/4" (19mm) is necessary to install the snap in switch (do not insert switch yet). Figure 8.3.

If an inverter switch is already in this place, move the strobe switch to the left of the inverter switch, directly in line with it.

Route the switch end of the switch harness under the steering column behind the panel and through the opening in the trim panel. AVOID MOVING/ROTATING OBJECTS. Figure 8.4 and 8.5.

Secure with zip ties.

Connect the ground spade to the gold pin on the rocker switch

Connect the white battery power spade to the opposite terminal on the switch.

Connect the red spade to the middle pin.

Insert the switch into the hole and place the strobe/beacon decal (if supplied) around the switch.

Reassemble all trim and secure wiring.

Figure 8.3

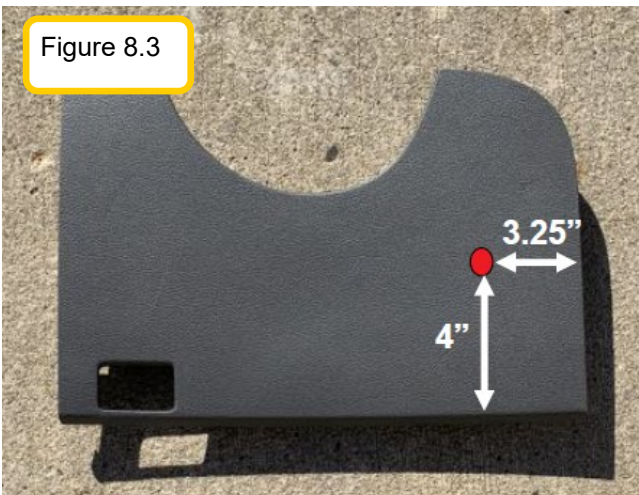

Figure 8.4

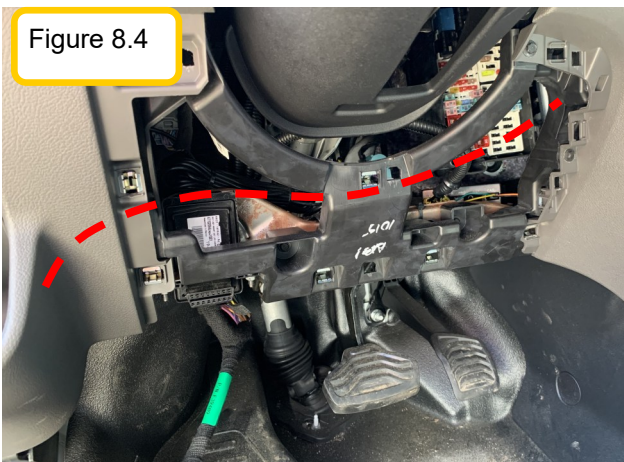
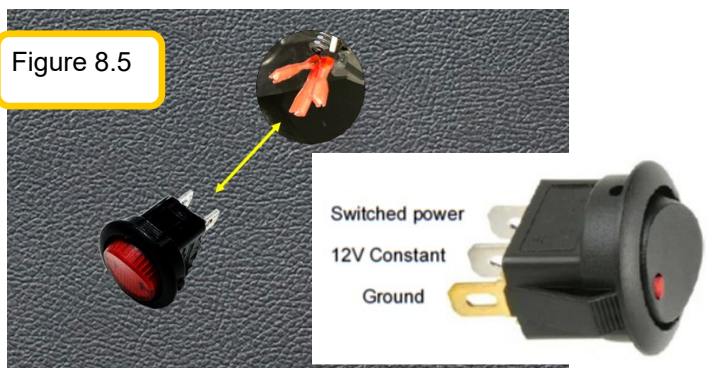

Figure 8.5



Strobe Install—If Applicable

Strobe pictures are for reference only. Please refer to product structure/spec sheets for the actual strobes for the install.

Figure 9.1



Step 1: (If you are installing a beacon, follow these routing steps with the beacon harness)

Locate the rear strobe harness #67109.

Connect the rear strobe harness to the switch harness (one of the remaining unused connectors) in the driver's foot well. Figure 9.1.

Step 2:

Locate the driver's side door sill area. Figure 9.2.

Carefully pull the rubber door trim up and route the strobe harness down to the floor. Figure 9.3.

Replace the rubber trim back into its original position.

Continue routing the harness down to the floor, under the sill trim, and under the driver's seat. See figure 9.4 for the routing path.

Re-insert trim that may have been pulled up after routing.

Figure 9.2

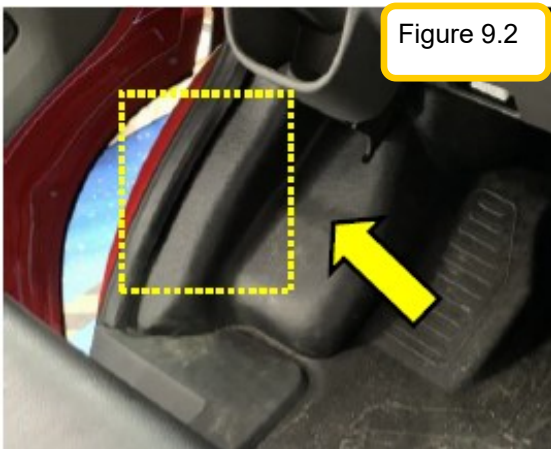

Figure 9.3

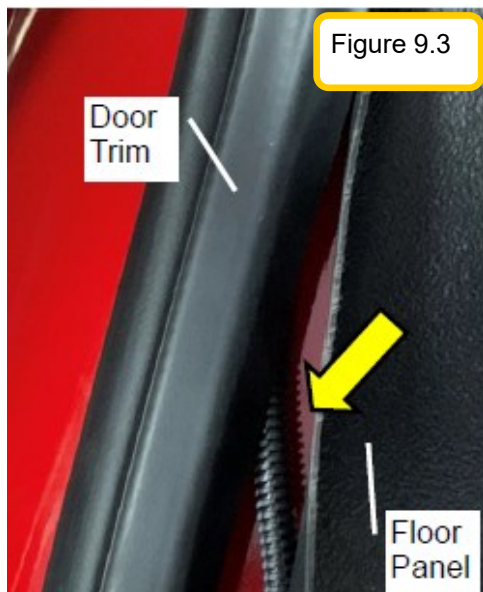

Figure 9.4

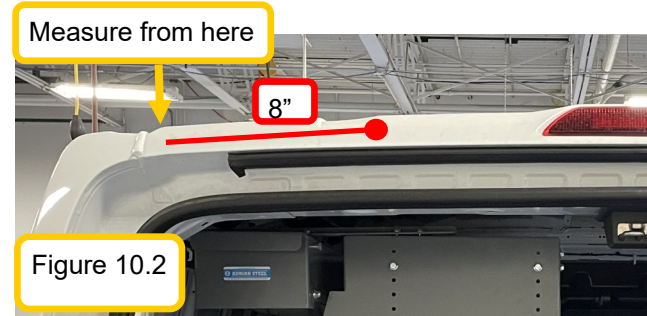



Figure 10.1

Step 3: Routing (Refer to routing diagrams at the beginning of the instructions)

Route the strobe harness up the backside of the partition and rearward following the OEM harness. The first strobe connection will be made in the top driver's side D-pillar—circled in green. The second connection will be made in the top passenger side d-pillar, also circled in green. Figure 10.1.



Measure from here

8"

Figure 10.2

Step 4: Mounting Strobes

Locate the rear side doors (outside of van). Measure and mark 8 inches right from the driver's side roof panel protrusion and 0.5 inches above the lower lip. If the bracket is not fitting perfectly with the contour of the van, move it down until it does. This will be the center of the strobe. Figures 10.2 and 10.3.

Figures 10.2 and 10.3..

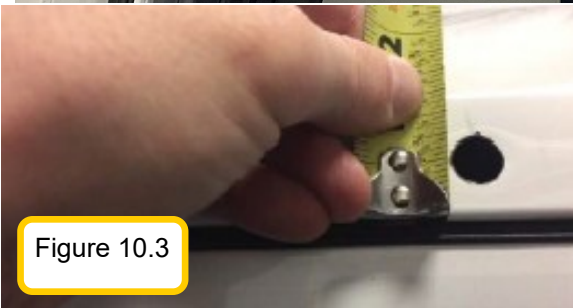

Figure 10.3

Drill a 1/2" hole for the wire pass through of the strobe. Figure 10.3.

Step 5: Locate the rear strobe bracket. Route the strobe light connector through the bracket and provided 3/8" grommet (34238-0) and attach it to the strobe harness. Figure 10.4.

Silicone the grommet hole opening and apply a small amount of silicone on the back of the bracket (van body side) around the hole. Tape up the non-needed blue or yellow wire on the strobe.

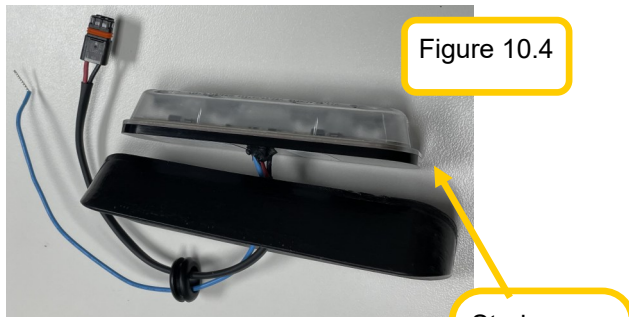
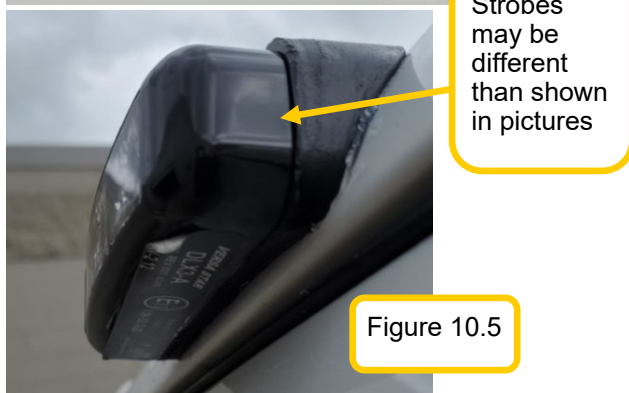

Figure 10.4

Use the supplied 6–20X1.5" tek screws (FAS0476) to attach the strobe to the bracket, and mount it to the body of the van.

Be sure to silicone the wire hole and the put a small dab of silicone in the screw holes before completely mounting the strobe.



Strobes may be different than shown in pictures

Figure 10.5

Place the strobes in their desired locations and fasten them onto the bumper with the supplied screws. You may want to drill pilot holes for ease of install. Figure 10.5.

*****TORQUE STROBES TO 10-IN-LB'S MAXIMUM*****

Repeat for the passenger side strobe.

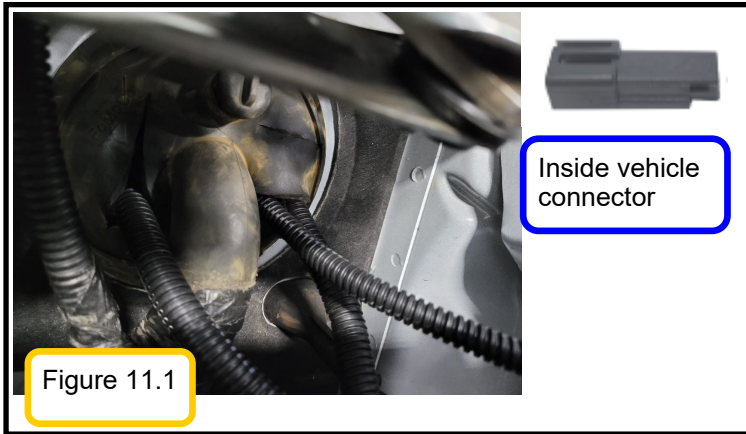

Step 5: Locate the front strobe harness #67102.

Start by routing the inside connector end of the harness to the firewall. This should be already routed through the grommet with the power harness and siliconed. If this is not done, please do this now. Refer to page 7 on the grommet and silicone needed. Figures 11.1 and 11.2.

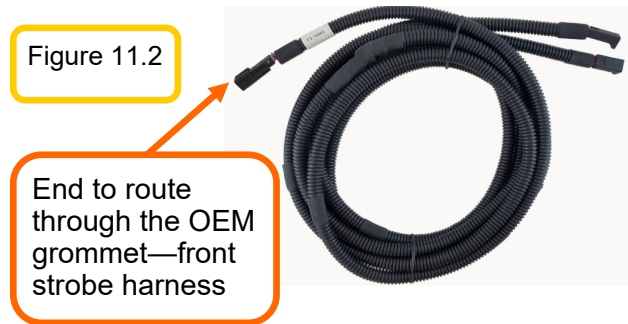

Connect the strobe harness to one of the un-used connectors on the switch harness. Figure 11.3.

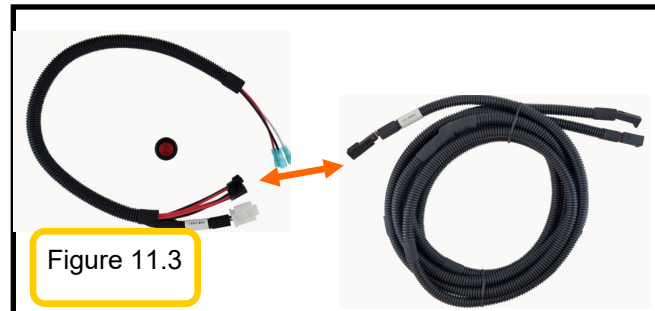

Step 6: Route the strobe connector ends to the each of the strobes. Follow the routing path shown in red in figures 11.4 and 11.5.

Secure wiring with zip ties. Figure 11.6.

Be sure not to secure or route the harness anywhere near moving or hot objects.

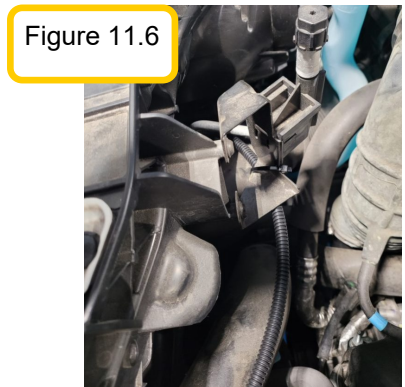
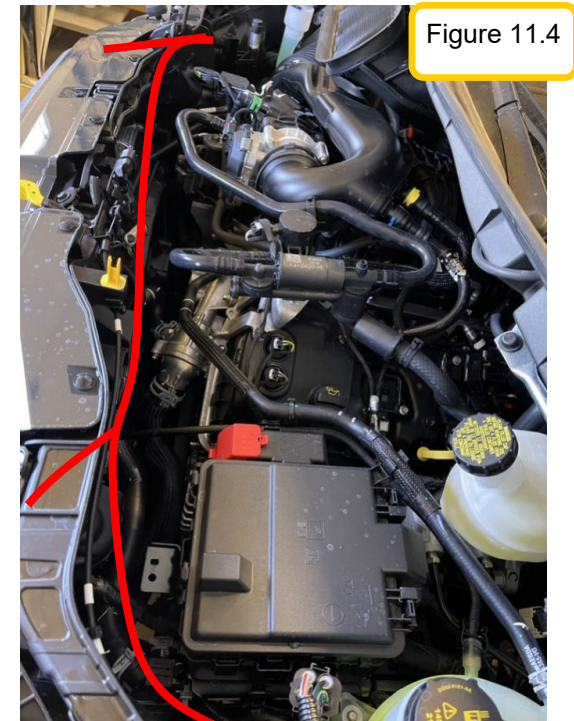

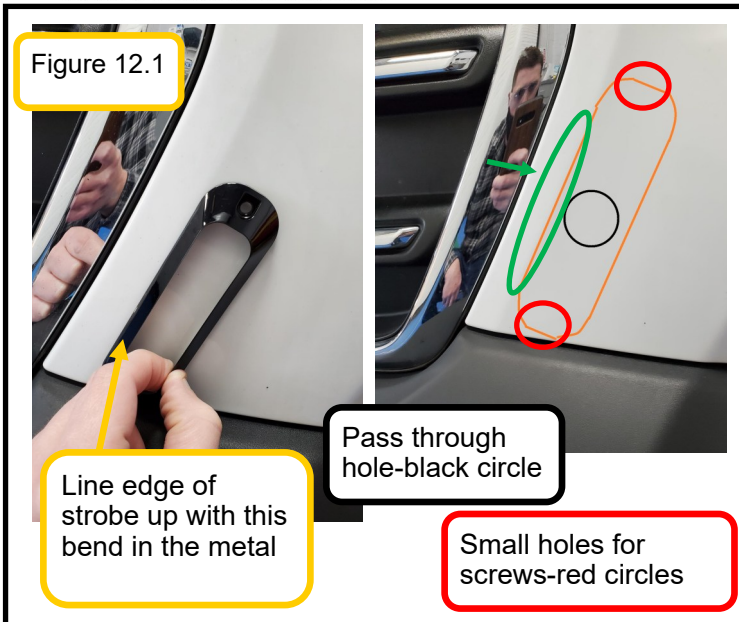

Step 7: Mounting Front Strobes
Locate the van front grill.

On the driver's side: Place the strobe on the lowest point of the contour, parallel with the bend in the sheet metal. See figures 12.1 and 12.2 for placement. This should be around 2" right of the headlight edge and 2" up from the bumper trim.

Use the strobe as a template, mark the center hole location on the panel (for routing the wires through).

Drill a 1/2" hole for the wire pass through on the strobe.

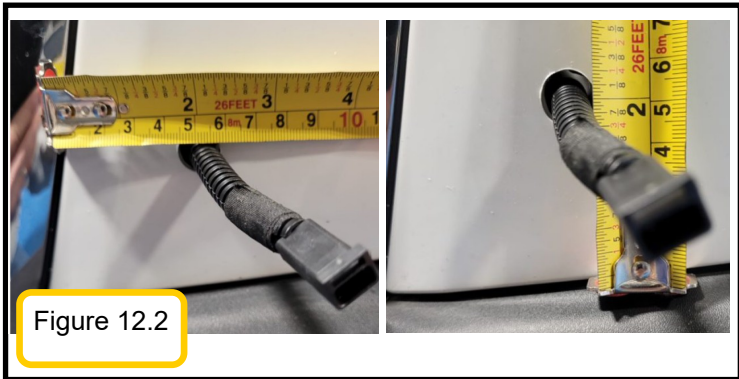

Route the strobe harness connectors through the holes.
Figure 12.3.

Only silicone the holes on the inside of the vehicle.
DO NOT SILI-CONE ON THE OUT-SIDE OF THE VEHICLE.

Connect the strobe to the strobe harness and tape up the non-needed blue or yellow wire.

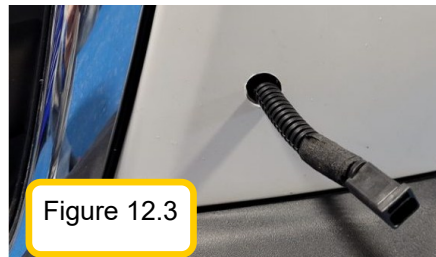

Place the strobes in their desired locations and fasten them onto the grill with the strobe light supplied screws. Drill pilot holes for an easier installation.
Figure 12.4.

*****TORQUE STROBES TO 10-IN-LB'S MAXIMUM*****

Repeat for the other side strobe.



Beacon/Lightbar Install—If Applicable

Lightbar/ beacon/ and mount pictures are for reference only. Please refer to product structure/ spec sheets for the actual beacon/lightbar/mount for the install.



Figure 13.1

Step 1: Routing (Refer to routing diagrams at the beginning of the instructions)

Locate the beacon harness # 67114 or 67115.

Connect the harness to the switch harness (one of the remaining unused connectors) in the driver's foot well.

Figure 13.1.

Locate the driver's side door sill area.

Figure 13.2.

Carefully pull the rubber door trim up and route the strobe harness down to the floor.

Figure 13.3.

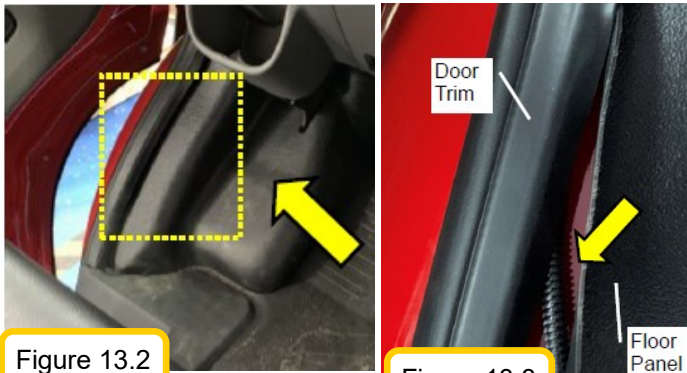

Figure 13.2



Figure 13.3

Replace the rubber trim back into its original position.

Continue routing the harness down to the floor, under the sill trim, and under the driver's seat. See figure 13.4 for the routing path.

Re-insert trim that may have been pulled up after routing.

Route the beacon harness up the backside of the partition and rearward following the OEM harness.

Figure 13.5.



Figure 13.4

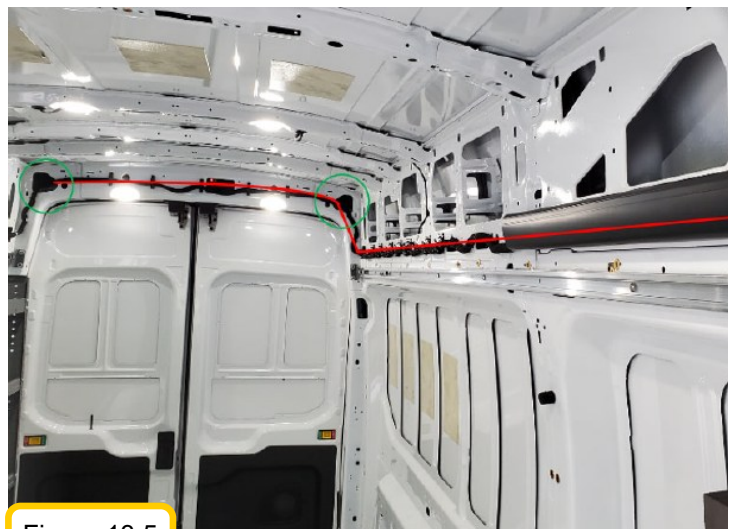

Figure 13.5



Roof mounted beacons:

Step 1: Locate the rear door area. Circled in figure 14.1.

Place the beacon or gasket in the center (between passenger and driver side). The two rear mounting screw locations should be through the single layer sheet metal, just ahead of the seam. See figure 14.2. for references on beacon mounting.

Use the beacon or gasket as a template and mark the holes.

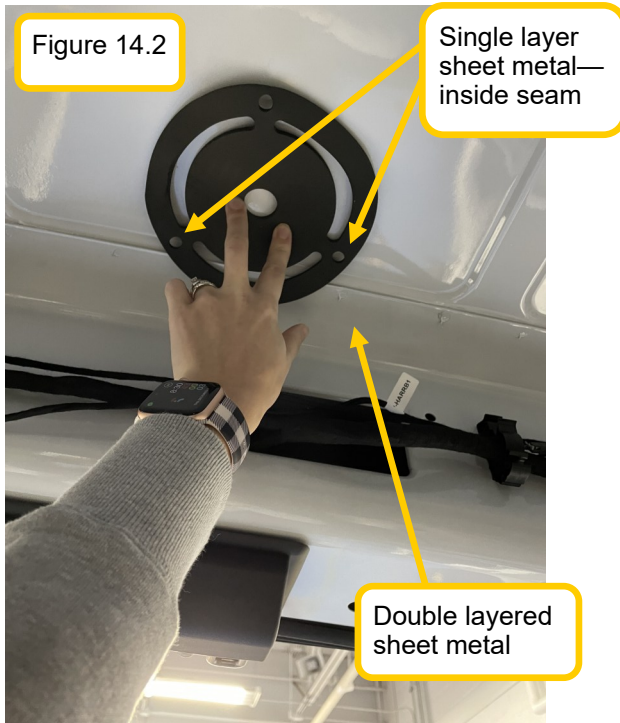

Step 2: Drill the holes needed to mount the beacon.

If there is a connector on the end of the lightbar/beacon, use the 1" grommet (36096-0). If there is not a connector, use the 3/8" grommet (70805) and refer to the next page for connector attachment.

Use primer on all the drilled holes.

Remove the cable gland off the beacon harness—you will not need this for roof mounting specifically, as the cable gland's job will be done with your grommet (and silicon) later. Figure 14.3.

*****TRANSIT HIGH ROOF ONLY: Nothing can be mounted on the roof for ship-thru (to meet train shipping restrictions). Ensure primer is dry. Then cover all drilled holes with waterproof tape and stow the remaining parts/instruction for final dealer assembly.*****

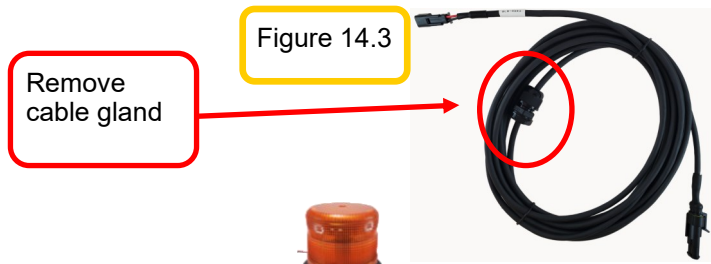

Insert the provided grommet, mentioned at the beginning of Step 2, into the wire pass through hole.

Route the beacon wires/connector through the grommet and use silicone to seal the hole.

Use the provided fasteners to mount the beacon to the roof.

Connect the beacon harness to the beacon.



Figure 15.1



Figure 15.2



Locate the connector housing inside the lightbar/beacon box. Figure 15.1.

Note if it has a red insert inside the connector or not. Refer to figure 15.2 for red insert inside the connector.

Insert the lightbar wire terminals into the connector. **See steps below:**

In these steps be very careful to place the terminals into the correct side of the connector.

Line the red wire terminal up with cavity #1 and the black wire terminal up with cavity #2. Figure 15.3.

Note the connector has a "1" and a "2" noted on the connector (circled in red). Figure 15.4. The red wire will be inserted into the #1 cavity of the connector. The black wire will be inserted into the #2 cavity on the connector.

Be sure to align the terminal prongs up with the inside of the connector pin outs.

Carefully insert the terminals into their designated section. Figure 15.5.

Also be sure the terminals snap into position. You should feel or hear a click when they are correctly inserted.

Pull on the wiring to be sure the connectors have been inserted completely.

If not already done:

Insert the red plastic piece into the top end of the connector. This will also click into place. Figure 15.6 and 15.7.

Silicone the grommet/wiring.

Figure 15.3



Figure 15.4



Figure 15.5

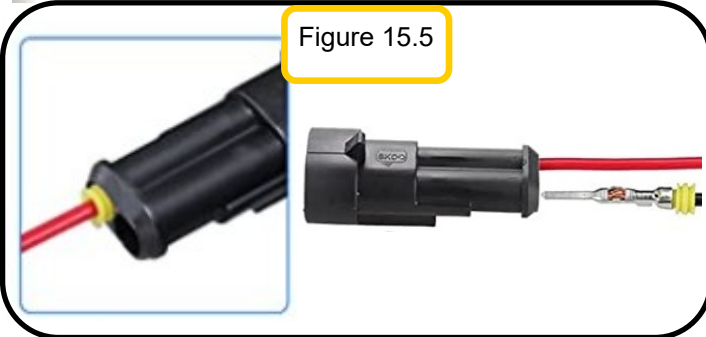

Figure 15.6

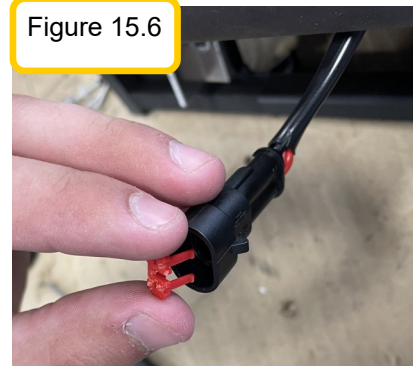
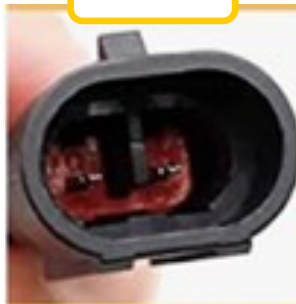

Figure 15.7



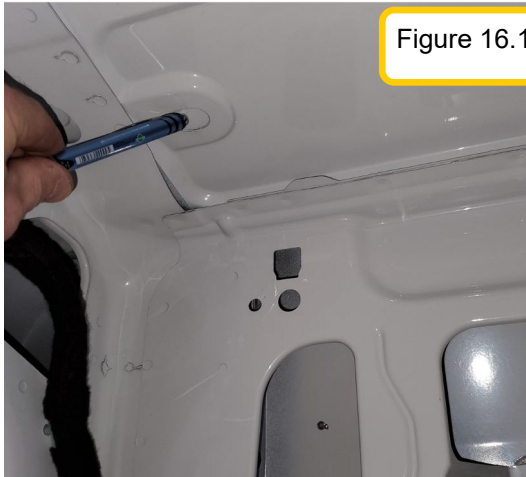

Figure 16.1

For ladder rack mounted beacon:

Step 1: Locate the OEM grommet/pass through at the rear driver's side d-pillar. Figure 16.1.

Drill a 5/8" (to fit the cable gland on the beacon harness) in the center for the wire pass through.

*****TRANSIT HIGH ROOF ONLY: Nothing can be mounted on the roof for ship-thru (to meet train shipping restrictions). Ensure primer is dry. Then cover all drilled holes with waterproof tape and stow the remaining parts/instruction for final dealer assembly.*****

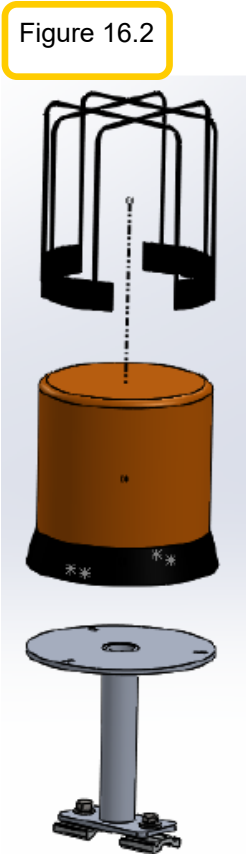

Figure 16.2

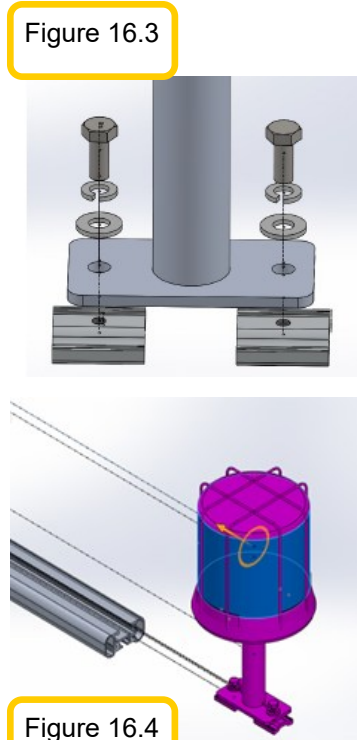

Figure 16.3

Figure 16.4

Route the beacon wire harness through the hole and insert the cable gland. Tighten the cable gland. Secure with zip-ties.

Step 2: Locate the beacon, beacon cage, and mount.

Run the beacon wires through the tube of the mount before mounting.

Use the provided nut, screw, and washer to mount the cage and beacon to the mount. Figure 16.1.

Assemble the beacon mount feet by inserting the bolt (FAS0799) through the lock washer (FAS0588) then flat washer (FAS0552) then through the foot into the slide. Do not tighten down at this point. Figure 16.3.

Step 3: Connect the beacon harness to the beacon now. You will need to remove the cap on the beacon harness. Tape up the unneeded yellow wire. Tuck the connector part of the harnesses up into the tube for easier routing.

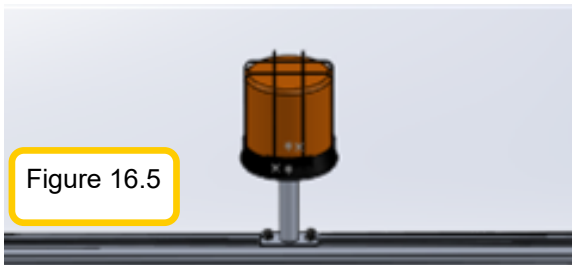
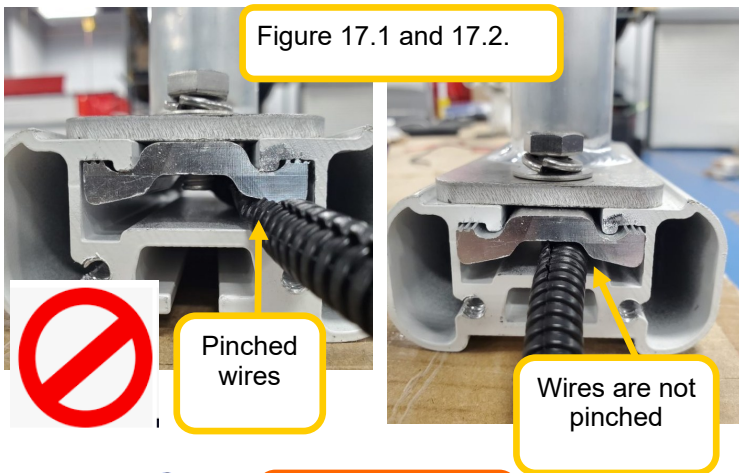

Figure 16.5

Slide the beacon/mount to the center of the rail. Be cautious of the wire sliding through the rail. Figure 16.4.

Tighten the bolts once you have positioned the beacon. Figure 16.5.



*****Be cautious the wires are not pinched after tightening the slides*****
See figures 17.1 and 17.2 for reference.

Step 4: Ladder Rack Routing

Option 1: (The preferred option)

Drill a 3/8" hole from the top channel to the bottom channel, 2" to the right of the where the foot mounts to the rail. See picture to the left for reference.

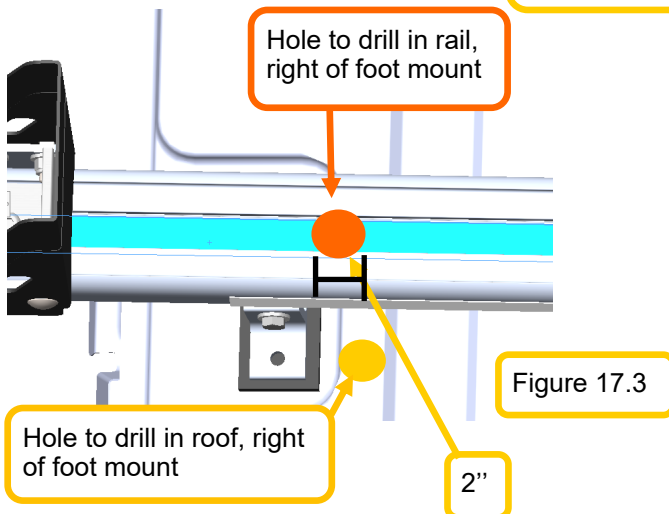

Route the wires in the top rail channel (before inserting the weather strip) to the drivers side area, through the hole in the rail, and down the foot to the hole in the roof. Figure 17.3.

Option 2: Drill a 3/8" hole from the top channel to the bottom channel directly under the beacon mount in the middle of the crossbow. Then route the wires through the hole to the bottom channel and down the channel to the end of the rail, drivers side.

On the 68" rack, measure 34" from the end. On the 58" rack measure 29" from the end.

Use the tek screws (FAS0842) and nylon clips (66843) to secure the wiring under the utility rack.

Routing is shown in yellow in figure 17.4. The hole is drilled beneath the beacon from the top channel to bottom.

Where you route the wires will depend on what all options you are installing on the utility rack.

If you are installing a few accessories onto the rail that mount to the bottom channel, use the top channel for wire

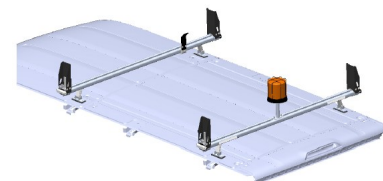
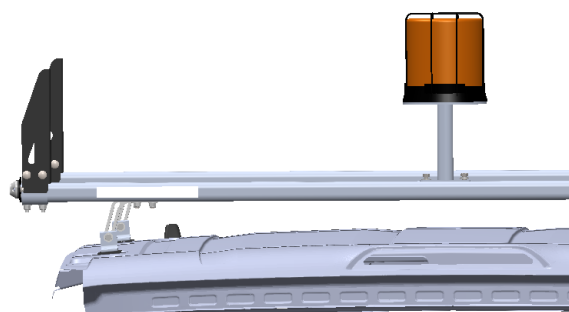
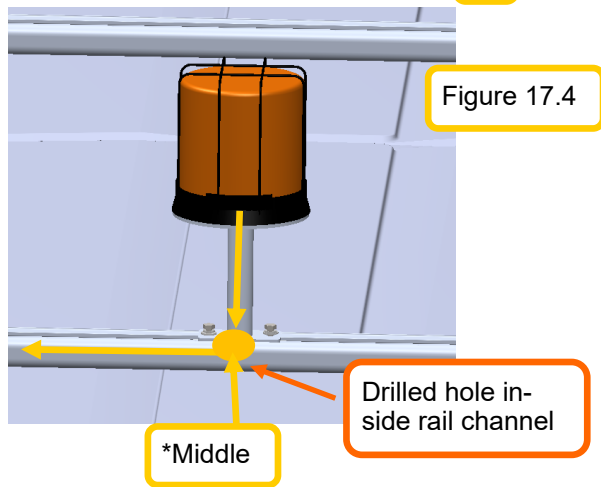

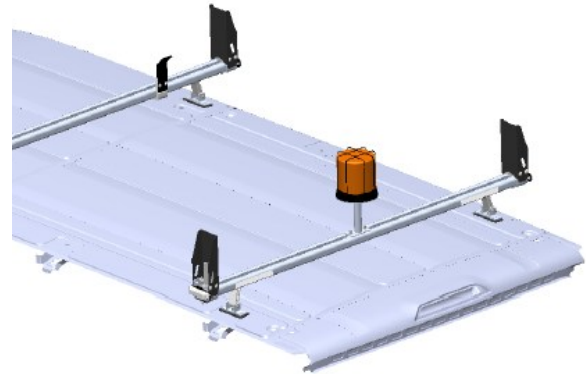

Insert the fuse into the inline-fuse holder on the power harness. The install is now complete. Secure all wiring with zip ties. Re-attach all trim. Re-assure all pass through holes have been silicone. Double check the functionality of the lights and switches.

PART NUMBER

26618-0

ITEM DESCRIPTION: SILICONE, 1oz. TUBE



SPECIFICATIONS: SU5005 RTV SILICONE
1oz. TUBE
CLEAR OR EQUIVALENT
SELF PIERCING CAP

SPECIAL NOTES:

SUPPLIED BY: THIS ITEM IS ADRIAN AVAILABLE!

PURCHASED PRODUCT DATA SHEET (PPDS)

THIS DRAWING/INFORMATION IS THE PROPERTY OF ADRIAN STEEL COMPANY AND IS NOT TO BE USED IN ANY MANNER THAT IS DETRIMENTAL TO THE INTEREST OF ADRIAN STEEL. COPYRIGHTS AND OR PATENTS THAT MAY BE THE PROPERTY OF APPLICABLE OWNERS MAY PROTECT INFORMATION AND/OR DRAWINGS OF SUPPLIED PRODUCTS.



ADRIAN STEEL
VAN AND PICKUP EQUIPMENT

906 JAMES STREET
ADRIAN, MI 49221
517-265-6194

WWW.ADRIANSTEEL.COM

CAUTION

WHEN INSTALLING EQUIPMENT IN OR ON VEHICLES CHECK FOR FUEL TANKS, FUEL LINES, CONTROL LINES AND ELECTRICAL WIRING BEFORE DRILLING! ALWAYS USE DRILL BITS WITH INTEGRAL STOPS WHENEVER POSSIBLE!

DRAWN BY
JLC

DATE DRAWN
7/21/2001

ECN NUMBER
16551

ECN DATE
7/22/2014

PART WEIGHT
0.02 LBS.

REV. LEVEL
C

PART NUMBER
26618-0

PART NUMBER

26618-0

ITEM DESCRIPTION: SILICONE, 1oz. TUBE



SPECIFICATIONS: SU5005 RTV SILICONE
1oz. TUBE
CLEAR OR EQUIVALENT
SELF PIERCING CAP

SPECIAL NOTES:

SUPPLIED BY: THIS ITEM IS ADRIAN AVAILABLE!

PURCHASED PRODUCT DATA SHEET (PPDS)

THIS DRAWING/INFORMATION IS THE PROPERTY OF ADRIAN STEEL COMPANY AND IS NOT TO BE USED IN ANY MANNER THAT IS DETRIMENTAL TO THE INTEREST OF ADRIAN STEEL. COPYRIGHTS AND OR PATENTS THAT MAY BE THE PROPERTY OF APPLICABLE OWNERS MAY PROTECT INFORMATION AND/OR DRAWINGS OF SUPPLIED PRODUCTS.



ADRIAN STEEL
VAN AND PICKUP EQUIPMENT

906 JAMES STREET
ADRIAN, MI 49221
517-265-6194

WWW.ADRIANSTEEL.COM

CAUTION

WHEN INSTALLING EQUIPMENT IN OR ON VEHICLES CHECK FOR FUEL TANKS, FUEL LINES, CONTROL LINES AND ELECTRICAL WIRING BEFORE DRILLING! ALWAYS USE DRILL BITS WITH INTEGRAL STOPS WHENEVER POSSIBLE!

DRAWN BY
JLC

DATE DRAWN
7/21/2001

ECN NUMBER
16551

ECN DATE
7/22/2014

PART WEIGHT
0.02 LBS.

REV. LEVEL
C

PART NUMBER
26618-0

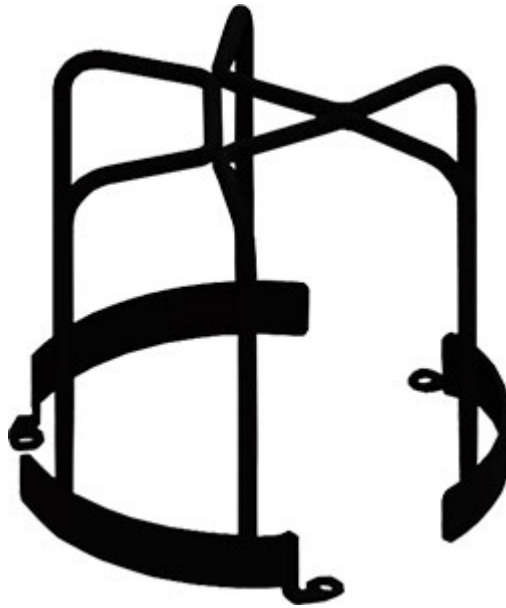
ITEM DESCRIPTION: BEACON GUARD

MANUFACTURER: STAR HEADLIGHT & LANTERN CO.
 MANUFACTURERS PART NUMBER: 274-55TS

SPECIFICATIONS: Beacon Guard for Star #257HTSL-A Beacon

SPECIAL NOTES: NONE

SUPPLIED BY: THIS ITEM IS ADRIAN AVAILABLE!

PURCHASED PRODUCT DATA SHEET (PPDS)

Page 1 of 1

THIS DRAWING/INFORMATION IS THE PROPERTY OF ADRIAN STEEL COMPANY AND IS NOT TO BE USED IN ANY MANNER THAT IS DETRIMENTAL TO THE INTEREST OF ADRIAN STEEL. COPYRIGHTS AND OR PATENTS THAT MAY BE THE PROPERTY OF APPLICABLE OWNERS MAY PROTECT INFORMATION AND/OR DRAWINGS OF SUPPLIED PRODUCTS.

**ADRIAN STEEL**

Cargo Management Solutions for Commercial Vehicles

906 JAMES STREET
 ADRIAN, MI 49221
 517-265-6194
 WWW.ADRIANSTEEL.COM

**CAUTION**

WHEN INSTALLING EQUIPMENT IN OR ON VEHICLES CHECK FOR FUEL TANKS, FUEL LINES, CONTROL LINES AND ELECTRICAL WIRING BEFORE DRILLING! ALWAYS USE DRILL BITS WITH INTEGRAL STOPS WHENEVER POSSIBLE!

DRAWN BY
RJBDATE DRAWN
02/17/2015ECN NUMBER
18023ECN DATE
11/13/2015PART WEIGHT
0.50 LBS.REV. LEVEL
A

PART NUMBER

50368

ITEM DESCRIPTION: STROBE SWITCH DECAL SET

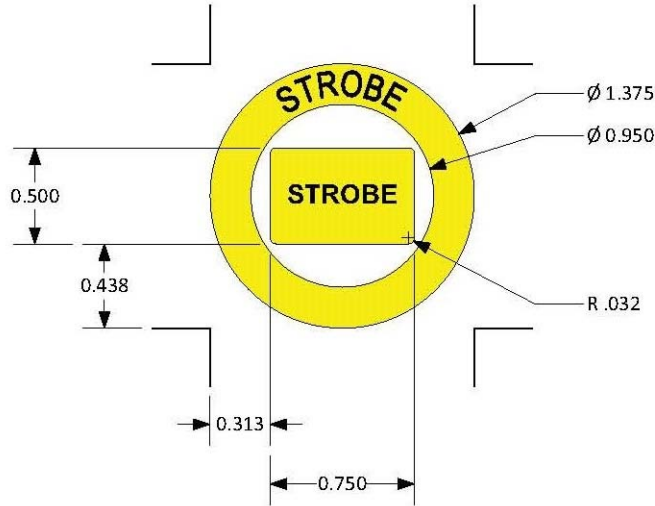

MANUFACTURER: VANNER
MANUFACTURERS PART NUMBER: TBD

SPECIFICATIONS: (1) Circular Yellow Decal (ID=0.950", OD=1.375") with "STROBE" in black letters
(1) Rectangular Yellow Decal (H=0.500", L=0.750") with "STROBE" in black letters

SPECIAL NOTES: For round rocker switch (OD=0.780") and Ford Transit Upfitter Switches.

SUPPLIED BY: THIS ITEM IS ADRIAN AVAILABLE!

PURCHASED PRODUCT DATA SHEET (PPDS)

THIS DRAWING/INFORMATION IS THE PROPERTY OF ADRIAN STEEL COMPANY AND IS NOT TO BE USED IN ANY MANNER THAT IS DETRIMENTAL TO THE INTEREST OF ADRIAN STEEL. COPYRIGHTS AND OR PATENTS THAT MAY BE THE PROPERTY OF APPLICABLE OWNERS MAY PROTECT INFORMATION AND/OR DRAWINGS OF SUPPLIED PRODUCTS.



**906 JAMES STREET
ADRIAN, MI 49221
517-265-6194
WWW.ADRIANSTEEL.COM**



CAUTION
WHEN INSTALLING EQUIPMENT IN OR ON VEHICLES CHECK FOR FUEL TANKS, FUEL LINES, CONTROL LINES AND ELECTRICAL WIRING BEFORE DRILLING! ALWAYS USE DRILL BITS WITH INTEGRAL STOPS WHENEVER POSSIBLE!

DRAWN BY RJB	DATE DRAWN 11/15/2017
ECN NUMBER XXXX	ECN DATE XXXXXX
PART WEIGHT 0.02 LBS.	REV. LEVEL A
PART NUMBER 55073	

REVISIONS			
REV	DESCRIPTION	DATE	REAE/CO

- NOTES:
1. MATERIAL : .002 YELLOW POLYESTER
 2. ARTWORK FROM D91XXXX-A PAGE 1, PMS BLACK
 3. .001 OVERLAMINATE
 4. ADHESIVE BACKED

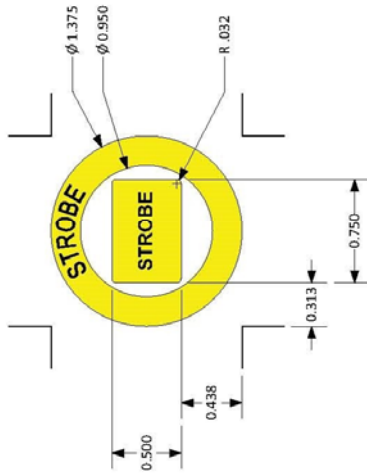

		HILLIARD, OHIO USA	
TOL. LABEL/METAL	.x ± .025 .xx ± .015 .xxx ± .005	REAE/CO NO.:	XXXX
TOL. CABLES	.xxx ± .25	THIS DRAWING AND ALL INFORMATION CONTAINED HEREIN IS THE PROPERTY OF VANNER INC. AND MAY NOT BE COPIED, REPRODUCED OR DIVULGED TO UNAUTHORIZED PERSONS WITHOUT THE EXPRESS WRITTEN CONSENT OF VANNER INC. IT IS PROVIDED SOLELY FOR THE CONVENIENCE OF THE USER AND SHALL BE RETURNED UPON REQUEST.	
DRN/DATE	MEO 11/14/17	SCALE:	NONE
CHK/DATE	XXX XXXX/XX	DRAWING AND ALL INFORMATION CONTAINED HEREIN IS THE PROPERTY OF VANNER INC. AND MAY NOT BE COPIED, REPRODUCED OR DIVULGED TO UNAUTHORIZED PERSONS WITHOUT THE EXPRESS WRITTEN CONSENT OF VANNER INC. IT IS PROVIDED SOLELY FOR THE CONVENIENCE OF THE USER AND SHALL BE RETURNED UPON REQUEST.	
TITLE:	LABEL, STROBE TXT, .95ID ROUND SWITCH		
DRAWING/ PART NO.	D01XXXX	SHEET	REV
		1 OF 1	A

THIS DRAWING/INFORMATION IS THE PROPERTY OF ADRIAN STEEL COMPANY AND IS NOT TO BE USED IN ANY MANNER THAT IS DETRIMENTAL TO THE INTEREST OF ADRIAN STEEL. COPYRIGHTS AND OR PATENTS THAT MAY BE THE PROPERTY OF APPLICABLE OWNERS MAY PROTECT INFORMATION AND/OR DRAWINGS OF SUPPLIED PRODUCTS.



906 JAMES STREET
ADRIAN, MI 49221
517-265-6194
WWW.ADRIANSTEEL.COM



WHEN INSTALLING EQUIPMENT IN OR ON VEHICLES CHECK FOR FUEL TANKS, FUEL LINES, CONTROL LINES AND ELECTRICAL WIRING BEFORE DRILLING! ALWAYS USE DRILL BITS WITH INTEGRAL STOPS WHENEVER POSSIBLE!

DRAWN BY RJB	DATE DRAWN 11/15/2017
ECN NUMBER XXXX	ECN DATE XXXXXXX
PART WEIGHT 0.02 LBS.	REV. LEVEL A
PART NUMBER 55073	

PART NUMBER
55073

LOC | QTY | Part # | Description | Size

Material: IJ39 | Lamination: 8518

1: 6039597.Strobe Switch-1.52" x 2.07"



Note: Part will not be weeded, just cut.

Kit# 8001872 | Adrian Steel Part # 55073

06/01/2023 • JY

© 2022 DISTYLL Graphics Solutions. All rights reserved.

ASCO REV.1 6/14/2023

 FINAL DESIGN	CLIENT NAME:		Switch Decals		O-ID: O15319-1
	Adrian Steel				Rev #: XXXX
	DATE:	DESIGNER:			Opt #: A
O5/31/2023	TRN				

Please check information to confirm accurate vehicle specifications.

CLEANING INSTRUCTIONS All surfaces must be considered contaminated. Clean the vehicle surface immediately before applying the film. Dust and other contaminants can collect quickly on the surface and prevent the film from adhering properly. Even a freshly painted surface can collect dust before graphics can be applied.

For the best success with the films recommended for vehicle graphics, always apply the graphics when the air and vehicle surface are both above 60°F (16°C) and below 90°F (32°C) before beginning the installation.

PURCHASED COMPONENT KEY FEATURES

DESCRIPTION OF REQUIREMENTS

DIMENSIONAL REQUIREMENTS (AS SHOWN ON DRAWING)

N/A

LOAD/RATING REQUIREMENT

N/A

MATERIAL REQUIREMENT

N/A

PACKAGING REQUIREMENT

N/A

OTHER REQUIREMENTS

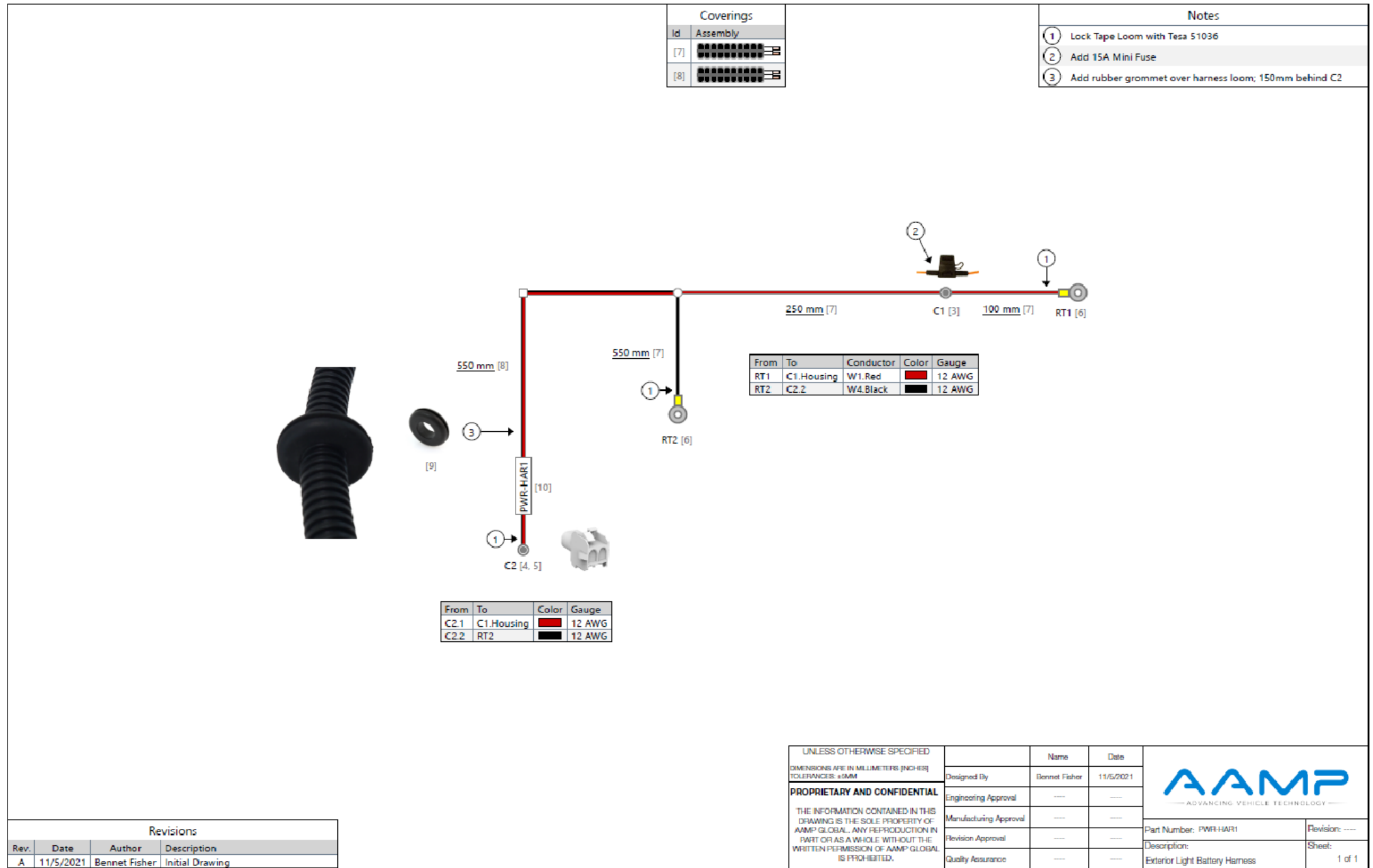

THIS DRAWING IS THE PROPERTY OF ADRIAN STEEL COMPANY AND IS NOT TO BE USED IN ANY MANNER DETRIMENTAL TO THE INTERESTS OF ADRIAN STEEL COMPANY

TOLERANCES & INSPECTION

UNLESS OTHERWISE SPECIFIED

ALL BEND ANGLES ARE 90 DEGREES

ALL DIMENSIONS ARE IN INCHES.

REFERENCE DIMENSIONS (X.XXX)
DO NOT REQUIRE INSPECTION

FEATURES	HOLES/SLOTS	ANGLES
0.0 = ± .125	0.0 = ± .062	0° = ± 2°
0.00 = ± .062	0.00 = ± .031	0.0° = ± 1°
0.000 = ± .031	0.000 = ± .015	

Material Thickness: per ASTM Std.
Weld Callouts per AWS

RELEASE & REVISIONS

INITIAL ECN: **25378**

CURRENT ECN: **25378**

ECN DESCRIPTION:

RELEASE FOR PRODUCTION

REVISED BY:

PURCHASED COMPONENT

REFERENCED SUPPLIER AND/OR MANUFACTURER

AAMP GLOBAL

REFERENCED SUPPLIER AND/OR MANUFACTURER PART NUMBER

67092 OR PWR-HAR1

COLOR (ONLY LIST IF COLOR SPECIFIC)

COMODITY ITEM (Y/N) (YES = ALL DIMENSIONS AND NOTES ARE REFERENCE)
(NOTE: DIMENSIONS AND FEATURES MAY VARY FOR A COMODITY ITEM.)

NO

PRINTED DOCUMENT IS UNCONTROLLED

Sheet 1 of 1

PART / PRODUCT IDENTIFICATION



ADRIAN STEEL

ADRIAN STEEL COMPANY
906 JAMES STREET, ADRIAN, MI 49221

REVISION LEVEL

A

MAT'L USED: **PURCHASED**

DESIGNED BY: **E.BURKE**

DESCRIPTION: **POWER HARNESS EXTERIOR 1**

WEIGHT (Lbs.): **0.2**

SEGMENT CODE: **ELE**

PART NUMBER: **67092**

Coverings	
Id	Assembly
[7]	
[8]	

Notes	
①	Lock Tape Loom with Tesa 51036
②	Add 15A Mini Fuse
③	Add rubber grommet over harness loom; 150mm behind C2

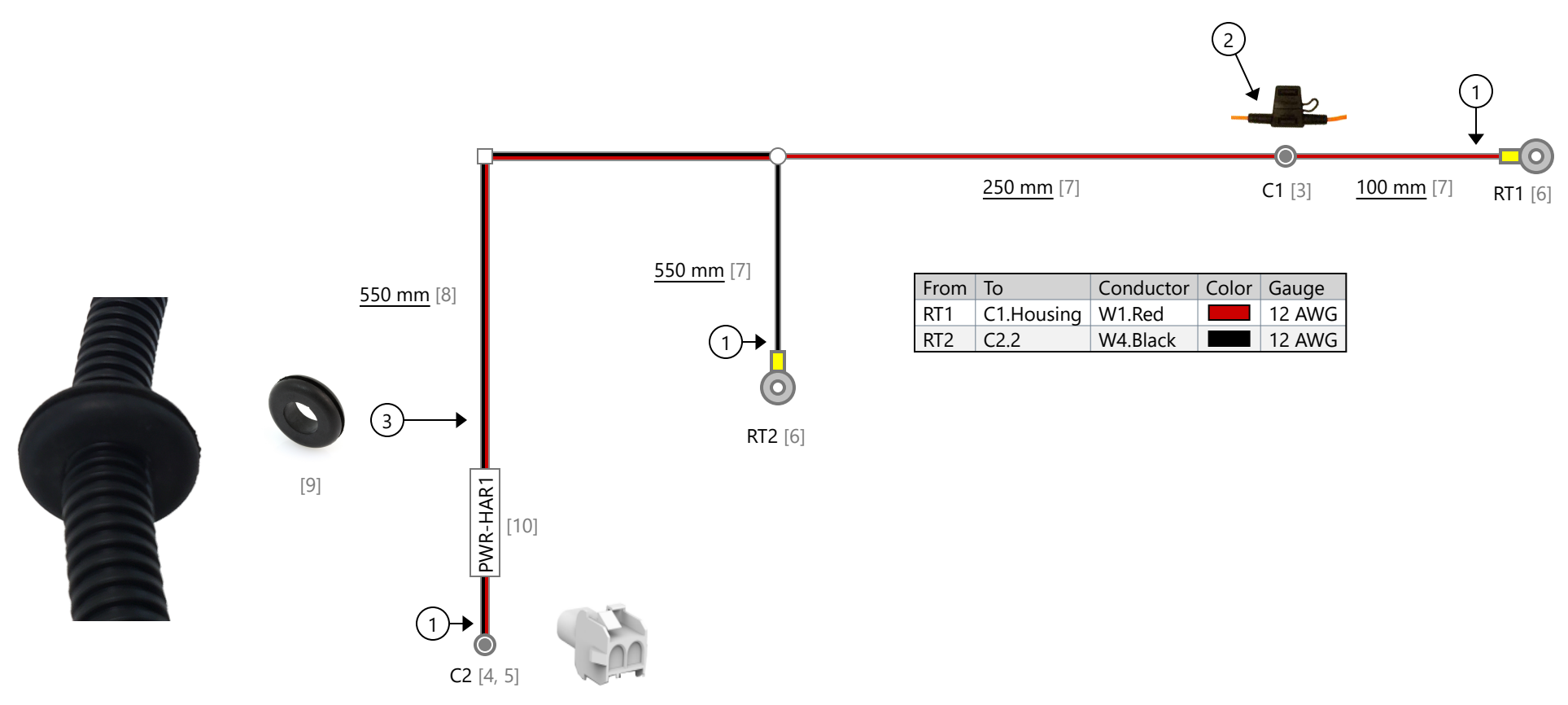

From	To	Conductor	Color	Gauge
RT1	C1.Housing	W1.Red		12 AWG
RT2	C2.2	W4.Black		12 AWG

From	To	Color	Gauge
C2.1	C1.Housing		12 AWG
C2.2	RT2		12 AWG

Revisions			
Rev.	Date	Author	Description
A	11/5/2021	Bennet Fisher	Initial Drawing

UNLESS OTHERWISE SPECIFIED DIMENSIONS ARE IN MILLIMETERS [INCHES] TOLERANCES: ±5MM PROPRIETARY AND CONFIDENTIAL THE INFORMATION CONTAINED IN THIS DRAWING IS THE SOLE PROPERTY OF AAMP GLOBAL. ANY REPRODUCTION IN PART OR AS A WHOLE WITHOUT THE WRITTEN PERMISSION OF AAMP GLOBAL IS PROHIBITED.	Designed By	Bennet Fisher	11/5/2021	 ADVANCING VEHICLE TECHNOLOGY
	Engineering Approval	----	----	
	Manufacturing Approval	----	----	
	Revision Approval	----	----	
	Quality Assurance	----	----	
Part Number: PWR-HAR1			Revision: ----	
Description: Exterior Light Battery Harness			Sheet: 1 of 1	

PURCHASED COMPONENT KEY FEATURES

DESCRIPTION OF REQUIREMENTS

DIMENSIONAL REQUIREMENTS (AS SHOWN ON DRAWING)

N/A

LOAD/RATING REQUIREMENT

N/A

MATERIAL REQUIREMENT

N/A

PACKAGING REQUIREMENT

N/A

OTHER REQUIREMENTS

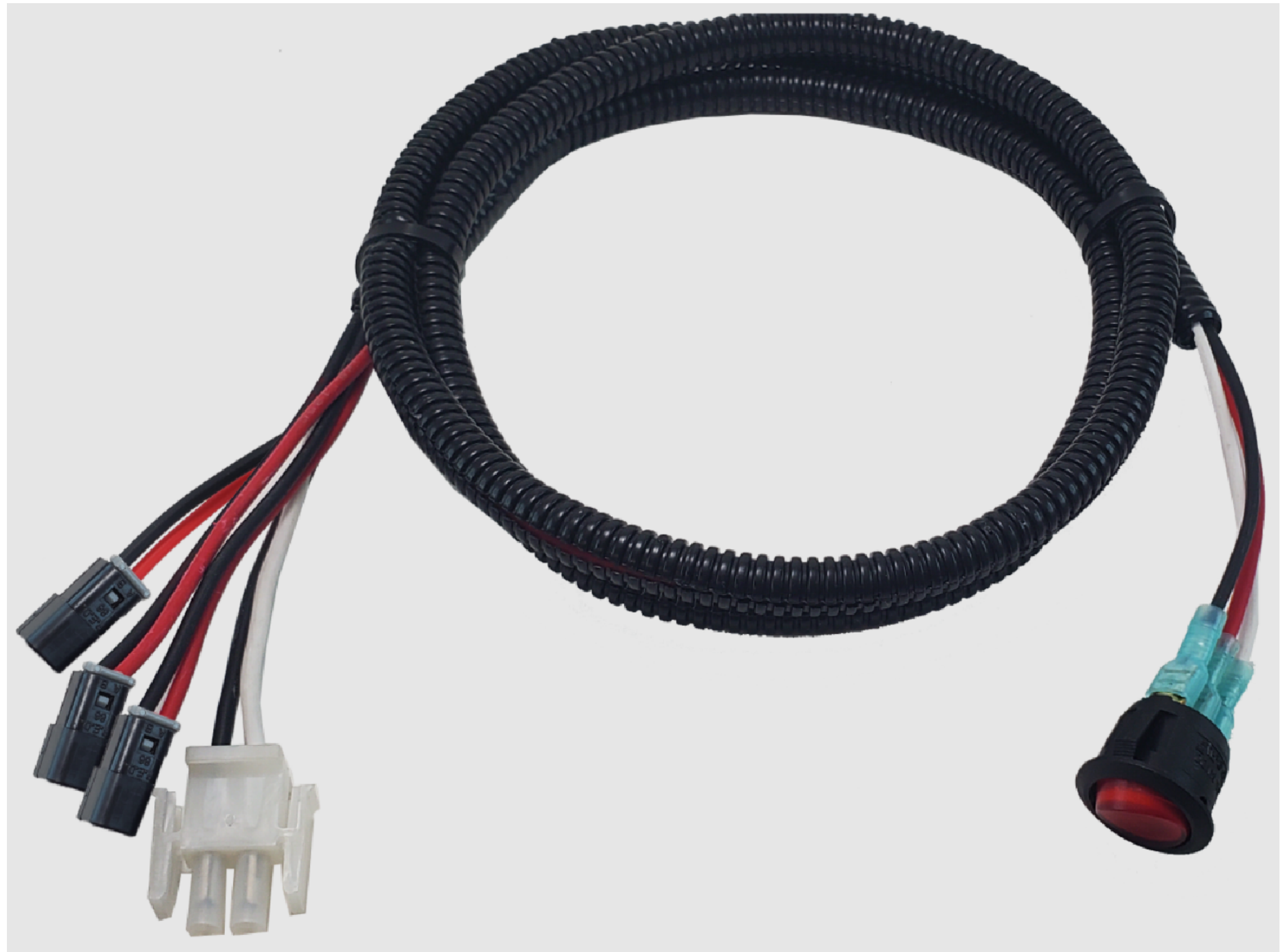

THIS DRAWING IS THE PROPERTY OF ADRIAN STEEL COMPANY AND IS NOT TO BE USED IN ANY MANNER DETRIMENTAL TO THE INTERESTS OF ADRIAN STEEL COMPANY

TOLERANCES & INSPECTION

UNLESS OTHERWISE SPECIFIED

ALL BEND ANGLES ARE 90 DEGREES

ALL DIMENSIONS ARE IN INCHES.

REFERENCE DIMENSIONS (X.XXX)
DO NOT REQUIRE INSPECTION

FEATURES	HOLES/SLOTS	ANGLES
0.0 = ± .125	0.0 = ± .062	0° = ± 2°
0.00 = ± .062	0.00 = ± .031	0.0° = ± 1°
0.000 = ± .031	0.000 = ± .015	

Material Thickness: per ASTM Std.
Weld Callouts per AWS

RELEASE & REVISIONS

INITIAL ECN: **25378**

CURRENT ECN: **25378**

ECN DESCRIPTION:

RELEASE FOR PRODUCTION

REVISED BY:

PURCHASED COMPONENT

REFERENCED SUPPLIER AND/OR MANUFACTURER

AAMP GLOBAL

REFERENCED SUPPLIER AND/OR MANUFACTURER PART NUMBER

SSW-HAR2 OR 67098

COLOR (ONLY LIST IF COLOR SPECIFIC)

COMODITY ITEM (Y/N) (YES = ALL DIMENSIONS AND NOTES ARE REFERENCE)
(NOTE: DIMENSIONS AND FEATURES MAY VARY FOR A COMODITY ITEM.)

NO

PRINTED DOCUMENT IS UNCONTROLLED

Sheet 1 of 1

PART / PRODUCT IDENTIFICATION



ADRIAN STEEL®

ADRIAN STEEL COMPANY
906 JAMES STREET, ADRIAN, MI 49221

REVISION LEVEL

A

MAT'L USED: **PURCHASED**

DESIGNED BY: **E.BURKE**

DESCRIPTION: **SWITCH HARNESS 2 EXTERIOR LIGHTING**

WEIGHT (Lbs.): **0.2**

SEGMENT CODE: **ELE**

PART NUMBER: **67098**

Coverings	
Id	Assembly
[12]	

Notes	
①	Lock Tape Loom with Tesa 51608
②	75mm between end of loom and Quick Connects

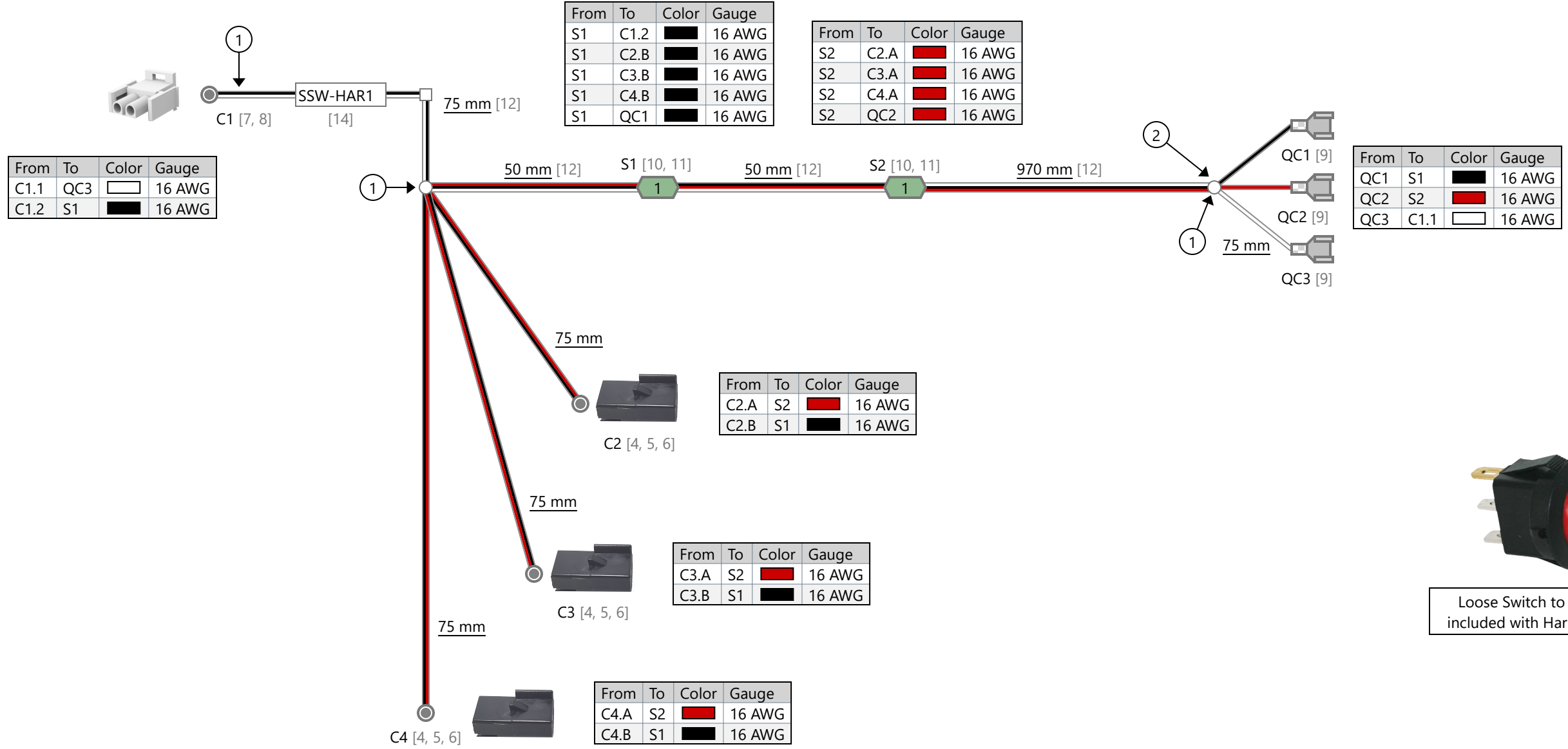

Revisions			
Rev.	Date	Author	Description
A	11/5/2021	Bennet Fisher	Initial Drawing

UNLESS OTHERWISE SPECIFIED DIMENSIONS ARE IN MILLIMETERS (INCHES) TOLERANCES: ±5MM		Name	Date
DESIGNED BY		Bennet Fisher	11/5/2021
ENGINEERING APPROVAL		----	----
MANUFACTURING APPROVAL		----	----
REVISION APPROVAL		----	----
QUALITY ASSURANCE		----	----

AAMP
— ADVANCING VEHICLE TECHNOLOGY —

Part Number: SSW-HAR2	Revision: ----
Description: Strobe Switch Harness - 3 Outputs	Sheet: 1 of 1

PROPRIETARY AND CONFIDENTIAL

THE INFORMATION CONTAINED IN THIS DRAWING IS THE SOLE PROPERTY OF AAMP GLOBAL. ANY REPRODUCTION IN PART OR AS A WHOLE WITHOUT THE WRITTEN PERMISSION OF AAMP GLOBAL IS PROHIBITED.

PURCHASED COMPONENT KEY FEATURES

DESCRIPTION OF REQUIREMENTS

DIMENSIONAL REQUIREMENTS (AS SHOWN ON DRAWING)

N/A

LOAD/RATING REQUIREMENT

N/A

MATERIAL REQUIREMENT

N/A

PACKAGING REQUIREMENT

N/A

OTHER REQUIREMENTS



THIS DRAWING IS THE PROPERTY OF ADRIAN STEEL COMPANY AND IS NOT TO BE USED IN ANY MANNER DETRIMENTAL TO THE INTERESTS OF ADRIAN STEEL COMPANY

TOLERANCES & INSPECTION

UNLESS OTHERWISE SPECIFIED

ALL BEND ANGLES ARE 90 DEGREES

ALL DIMENSIONS ARE IN INCHES.

REFERENCE DIMENSIONS (X.XXX)
DO NOT REQUIRE INSPECTION

FEATURES	HOLES/SLOTS	ANGLES
0.0 = ± .125	0.0 = ± .062	0° = ± 2°
0.00 = ± .062	0.00 = ± .031	0.0° = ± 1°
0.000 = ± .031	0.000 = ± .015	

Material Thickness: per ASTM Std.
Weld Callouts per AWS

RELEASE & REVISIONS

INITIAL ECN: **25378**

CURRENT ECN: **25378**

ECN DESCRIPTION:

RELEASE FOR PRODUCTION

REVISED BY:

PURCHASED COMPONENT

REFERENCED SUPPLIER AND/OR MANUFACTURER

AAMP GLOBAL

REFERENCED SUPPLIER AND/OR MANUFACTURER PART NUMBER

BLB-HAR5 OR 67115

COLOR (ONLY LIST IF COLOR SPECIFIC)

COMODITY ITEM (Y/N) (YES = ALL DIMENSIONS AND NOTES ARE REFERENCE)
(NOTE: DIMENSIONS AND FEATURES MAY VARY FOR A COMODITY ITEM.)

NO

PRINTED DOCUMENT IS UNCONTROLLED

Sheet 1 of 1

PART / PRODUCT IDENTIFICATION



ADRIAN STEEL®

ADRIAN STEEL COMPANY
906 JAMES STREET, ADRIAN, MI 49221

REVISION LEVEL

A

MAT'L USED: **PURCHASED**

DESIGNED BY: **E.BURKE**

DESCRIPTION: **BEACON/LIGHTBAR HARNESS 5**

WEIGHT (Lbs.): **0.2**

SEGMENT CODE: **EBE**

PART NUMBER: **67115**

Bill of Materials				
Id	Type	Manufacturer	Part Number	Quantity
1	Cable		16AWG 2C FT2 TPU Cable	10750 mm
2	Cord Grip		PG11	1

Notes	
①	Heat shrink cable jacket and wire 20mm behind connector (Heat shrink = 38mm long)
②	Place adhesive lined heat shrink over C2 connector wire cavities and cable jacket (Heat shrink = 38mm long)
③	Install Cable Gland/Cord Grip 300mm behind C2
④	Plug C3 into C2
⑤	C3 Cavities are sealed



From	To	Color	Gauge
C1.A	C2.1	Red	16 AWG
C1.B	C2.2	Black	16 AWG

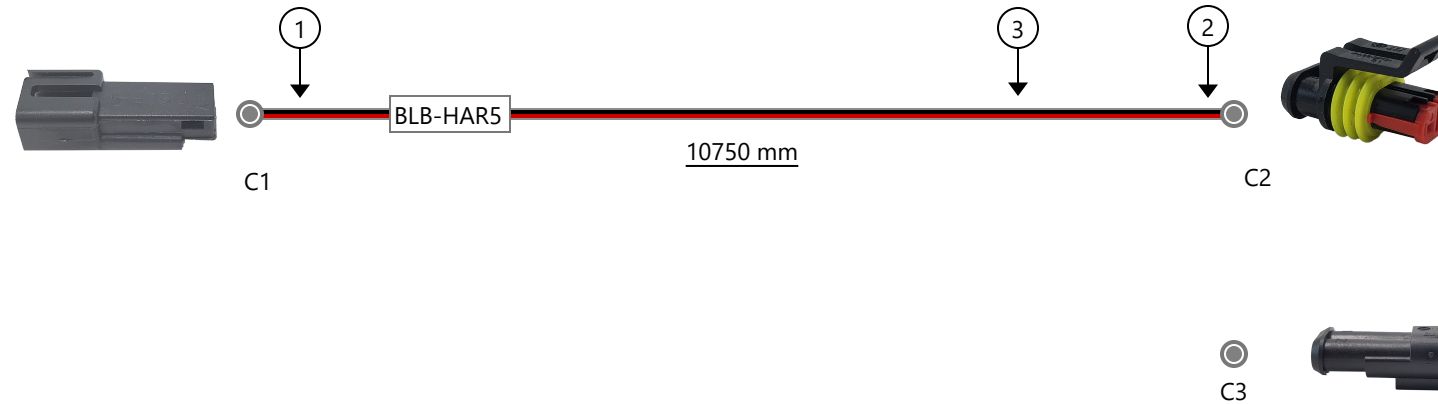

From	To	Color	Gauge
C2.1	C1.A	Red	16 AWG
C2.2	C1.B	Black	16 AWG

Revisions			
Rev.	Date	Author	Description
	11/5/2021	Bennet Fisher	Initial Drawing
	3/21/2022	Bennet Fisher	Added 300mm to harness; changed female connector
A	4/26/2022	Bennet Fisher	Added adhesive lined heat shrink to C2

UNLESS OTHERWISE SPECIFIED DIMENSIONS ARE IN MILLIMETERS [INCHES] TOLERANCES: ±5MM PROPRIETARY AND CONFIDENTIAL THE INFORMATION CONTAINED IN THIS DRAWING IS THE SOLE PROPERTY OF AAMP GLOBAL. ANY REPRODUCTION IN PART OR AS A WHOLE WITHOUT THE WRITTEN PERMISSION OF AAMP GLOBAL IS PROHIBITED.		Name	Date	
	Designed By	Bennet Fisher	04/26/2022	
	Engineering Approval			
	Manufacturing Approval			
	Revision Approval			
Quality Assurance				
	Part Number: BLB-HAR5_		Revision: A	
	Description: Beacon/Light Bar Harness - 10.75 Meters		Sheet: 1	

PURCHASED COMPONENT KEY FEATURES

DESCRIPTION OF REQUIREMENTS

DIMENSIONAL REQUIREMENTS (AS SHOWN ON DRAWING)

N/A

LOAD/RATING REQUIREMENT

N/A

MATERIAL REQUIREMENT

N/A

PACKAGING REQUIREMENT

N/A

OTHER REQUIREMENTS

**ECCO BEACON LIGHT: 7965A
WITH EXTERIOR PLUG AND PLAY CONNECTOR
AMBER LENS, WHITE LEDS**



THIS DRAWING IS THE PROPERTY OF ADRIAN STEEL COMPANY AND IS NOT TO BE USED IN ANY MANNER DETRIMENTAL TO THE INTERESTS OF ADRIAN STEEL COMPANY

TOLERANCES & INSPECTION

UNLESS OTHERWISE SPECIFIED

ALL BEND ANGLES ARE 90 DEGREES

ALL DIMENSIONS ARE IN INCHES.

REFERENCE DIMENSIONS (X.XXX)
DO NOT REQUIRE INSPECTION

FEATURES	HOLES/SLOTS	ANGLES
0.0 = ± .125	0.0 = ± .062	0° = ± 2°
0.00 = ± .062	0.00 = ± .031	0.0° = ± 1°
0.000 = ± .031	0.000 = ± .015	

Material Thickness: per ASTM Std.
Weld Callouts per AWS

RELEASE & REVISIONS

INITIAL ECN: **25921**

CURRENT ECN: **25921**

ECN DESCRIPTION:

RELEASE TO PRODUCTION

REVISED BY: **N/A**

PURCHASED COMPONENT

REFERENCED SUPPLIER AND/OR MANUFACTURER

ECCO

REFERENCED SUPPLIER AND/OR MANUFACTURER PART NUMBER

7965A-ADR

COLOR (ONLY LIST IF COLOR SPECIFIC)

AMBER LENS/WHITE LEDS

COMODITY ITEM (Y/N) (YES = ALL DIMENSIONS AND NOTES ARE REFERENCE)
(NOTE: DIMENSIONS AND FEATURES MAY VARY FOR A COMODITY ITEM.)

NO

PRINTED DOCUMENT IS UNCONTROLLED

Sheet 1 of 1

PART / PRODUCT IDENTIFICATION



ADRIAN STEEL®

ADRIAN STEEL COMPANY
906 JAMES STREET, ADRIAN, MI 49221

REVISION LEVEL

A

MAT'L USED: **PURCHASED**

DESIGNED BY: **EMB**

DESCRIPTION: **ECCO LED BCN 7965 W/CONN**

WEIGHT (Lbs.): **1.5**

SEGMENT CODE: **EBE**

PART NUMBER: **67689**