

Introduction / Comments:

Install Instructions For Exterior Plug & Play Lights For F250+

Note:

Read all instructions prior to installation. Review the Adrian Steel **GENERAL PRECAUTIONS PAGES (56638)** before attempting installation. Only personnel familiar with using electrical best practices should perform this install. Reference **ELECTRICAL BEST PRACTICES MANUAL (54479)** before attempting installation.



Installation Instructions For Exterior Plug And Play Lights For F250+

Table of Contents:

Torque requirements.....	2
Best Practices for Routing Through the Firewall.....	3
Introduction Statement.....	4
Overall Harness Diagram.....	4
Tools needed.....	4
Harnesses/Components Needed (If Applicable).....	5
Component Placements.....	6
Overall Harness Routing.....	7-8
Beginning Install.....	9
Strobe Installation Instructions.....	11
Beacon/Lightbar Installation Instructions.....	15

*****TORQUE*****
Torque all strobe fasteners to 10 in-lbs.
DO NOT OVER TIGHTEN

DO NOT MOUNT ON A CURVED SURFACE

Best Practices to Follow when Routing Through Firewall:

- Create a drip loop with the harness being routed through the firewall as shown so that the water does not flow into the grommet.
- Make sure that the proper grommet for the hole being routed through is used so that there are no openings for water to get through.
- Use silicone after routing and apply around the grommet and wire to seal it. Make sure to let the silicone dry for 30 minutes to an hour.

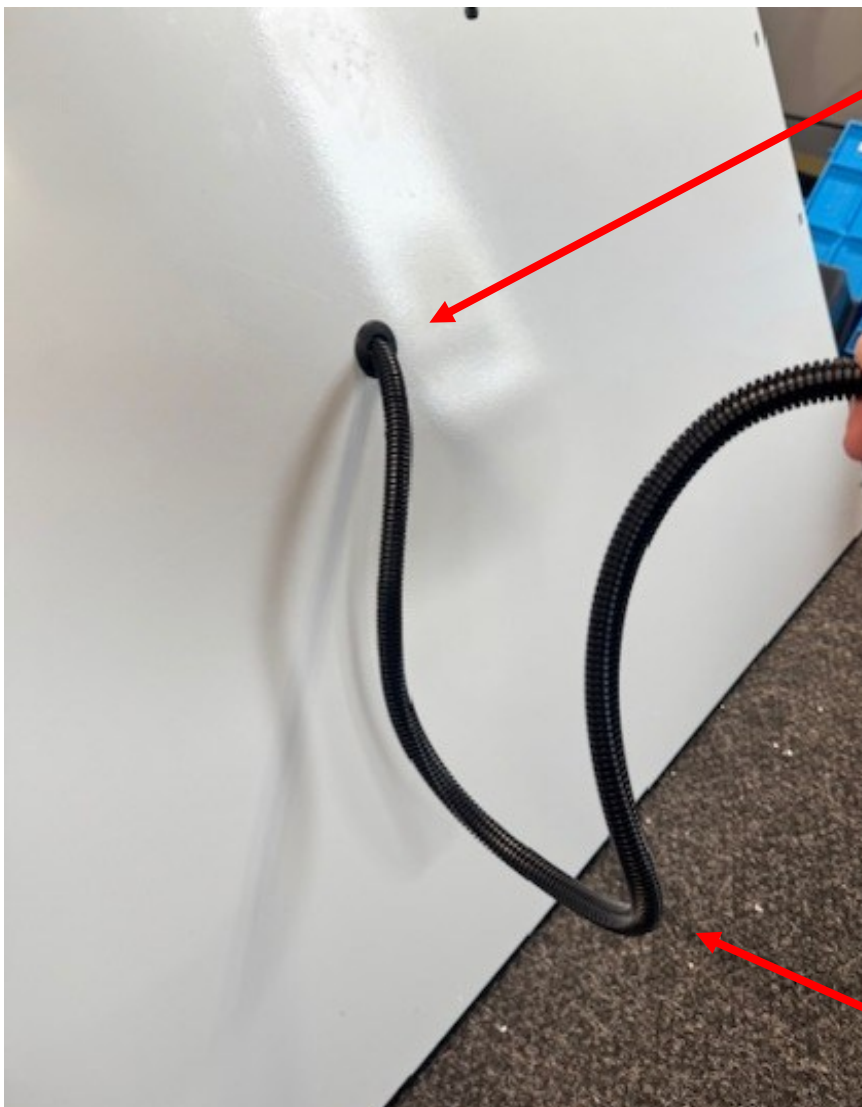

Apply silicone around the grommet and wire loom so that it is completely sealed.

Drip loop created so water runs off of loom and not into the cab of the vehicle.

****Please read statement below before moving forward****

Before installation, disconnect the OEM negative battery cable.

These plug and play kits are completely modular and can be configured in many different ways. Placement of lights will be determined by sales order drawings/customer ask. Therefore, these instructions are for the most standard configurations, and for reference only.

Please reference the order drawing and spec sheet to see what components are going to be installed on this particular upfit.

These installation instructions are for most cases and for reference. Not all installs will have strobes, beacons, and lightbars. Reference the instructions for only what you are installing.

Overall Harness Diagram

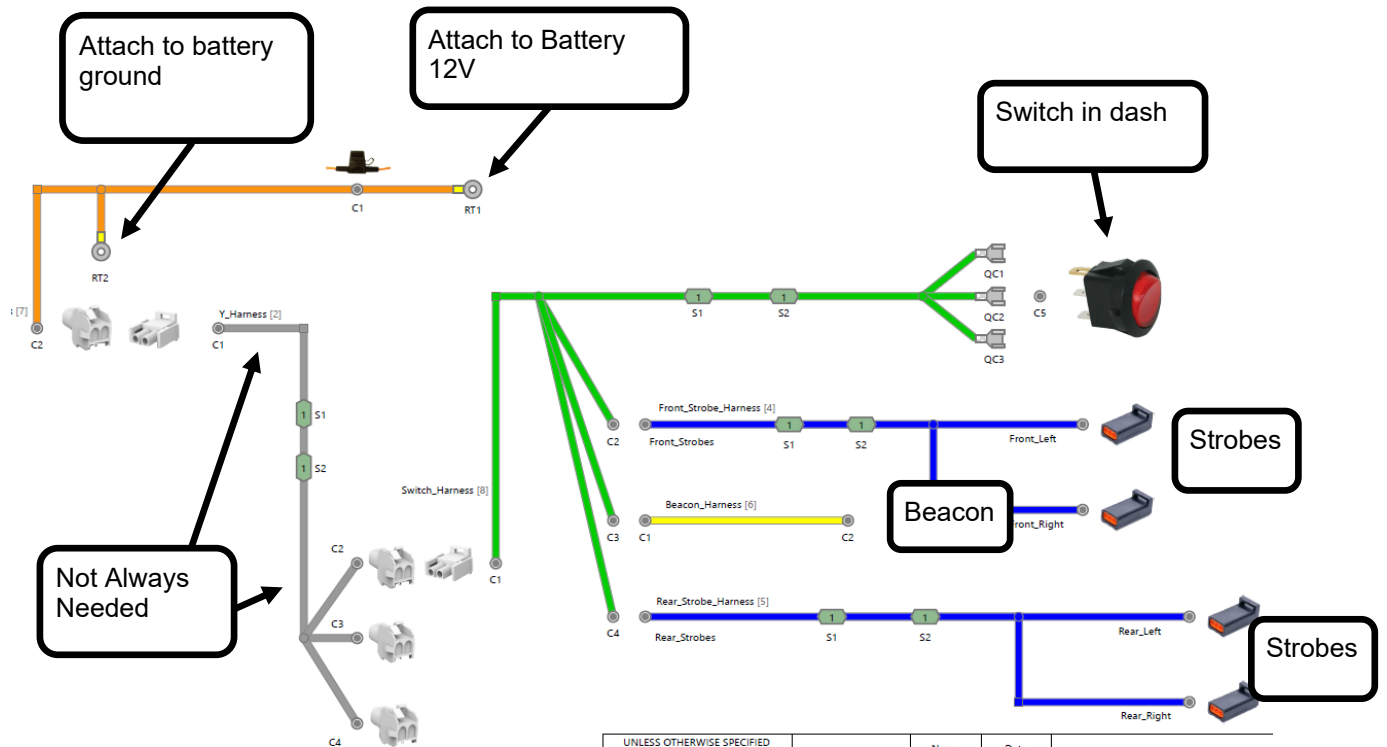

Tools required:

13 socket and 20 torx bit

Phillips bit and 5/16" step drill bit

Power drill and impact

Torque wrench

Components

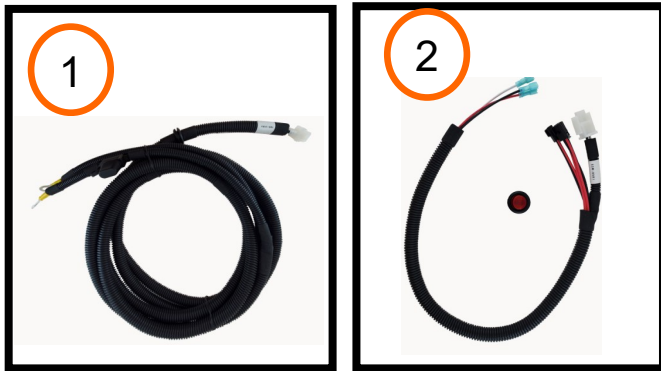

	Part Number	Description
1	67095	Power Harness #4
2	67097	Switch Harness #1
3	67104	Front Strobe Harness #4 (If Applicable)
4	67108	Rear Strobe Harness #3 (If Applicable)
5	67113	Beacon/Lightbar Harness #3 (If Applicable)
6	67686 or 67687	Strobes (If Applicable)
7	67689 or 67690	Beacons (If Applicable)
8	52769 or 56075	Beacon/Lightbar Mount (If Applicable)
9	67691 or 67692 or 96118 or 67693	Lightbars (If Applicable)



The purpose of plug and play lighting is to be completely modular. Due to this feature, refer to the order drawing for all exact lighting placements. These installation instructions are for most cases and for reference. Not all installs will have strobes, beacons, and lightbars. Reference the instructions for only what you are installing.

Harness pictures are for reference only.

Placements

Switch placement: Dash panel
under headlight buttons



Front Strobes: Grill
1.25 In. from top



*****TORQUE STROBES TO 10-IN-LB'S
MAXIMUM*****

Beacon or Lightbar: On CHMSL
above 3rd brake light—on some
sort of mount

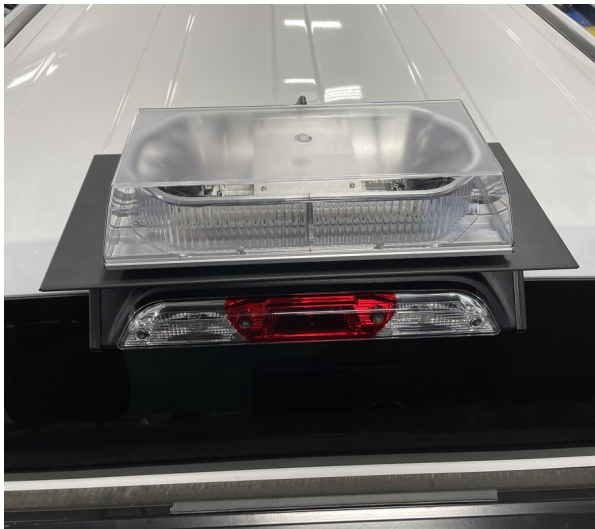

Rear Strobes: Rear Bumper
5.5 In. from the sensor



Routing Overview

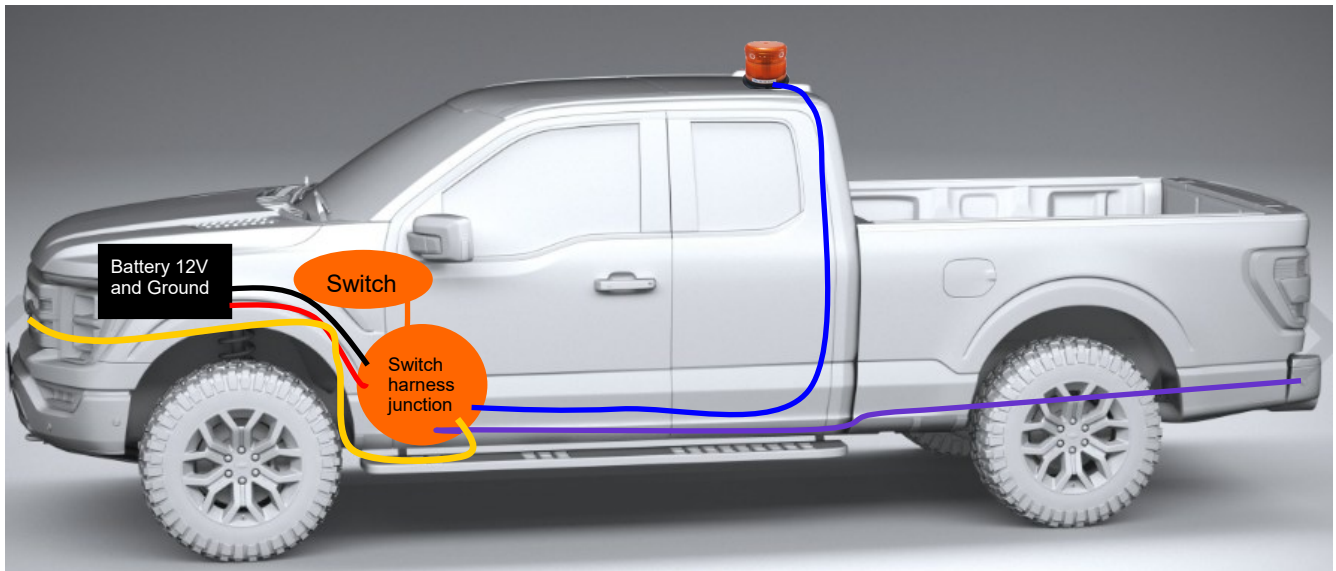
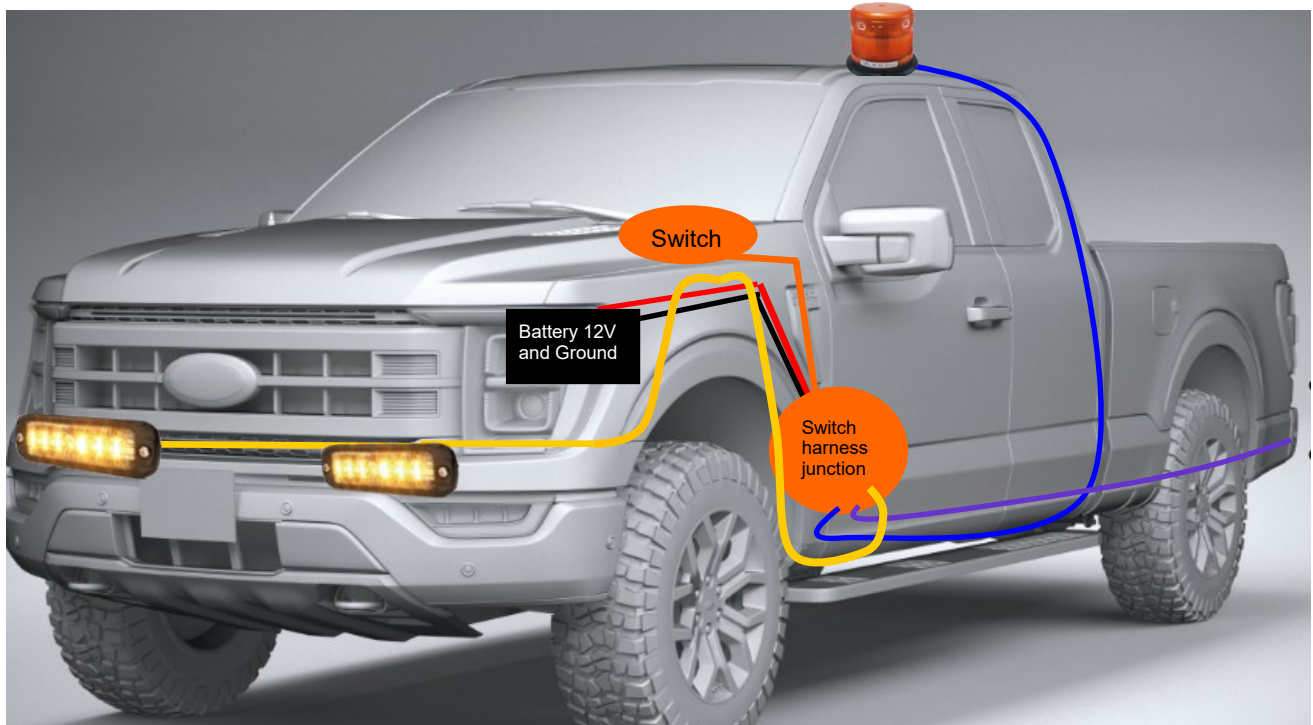

Color	Key - Items
Yellow	Strobes - Front strobe harness #4
Red/Black	Power harness: Battery to kick panel
Orange	Switch harness: Switch in dash
Blue	Beacon harness: Switch to beacon
Purple	Strobes - Rear strobe harness #3



Overview of Routing-Beacon/Lightbar Wire Harness:

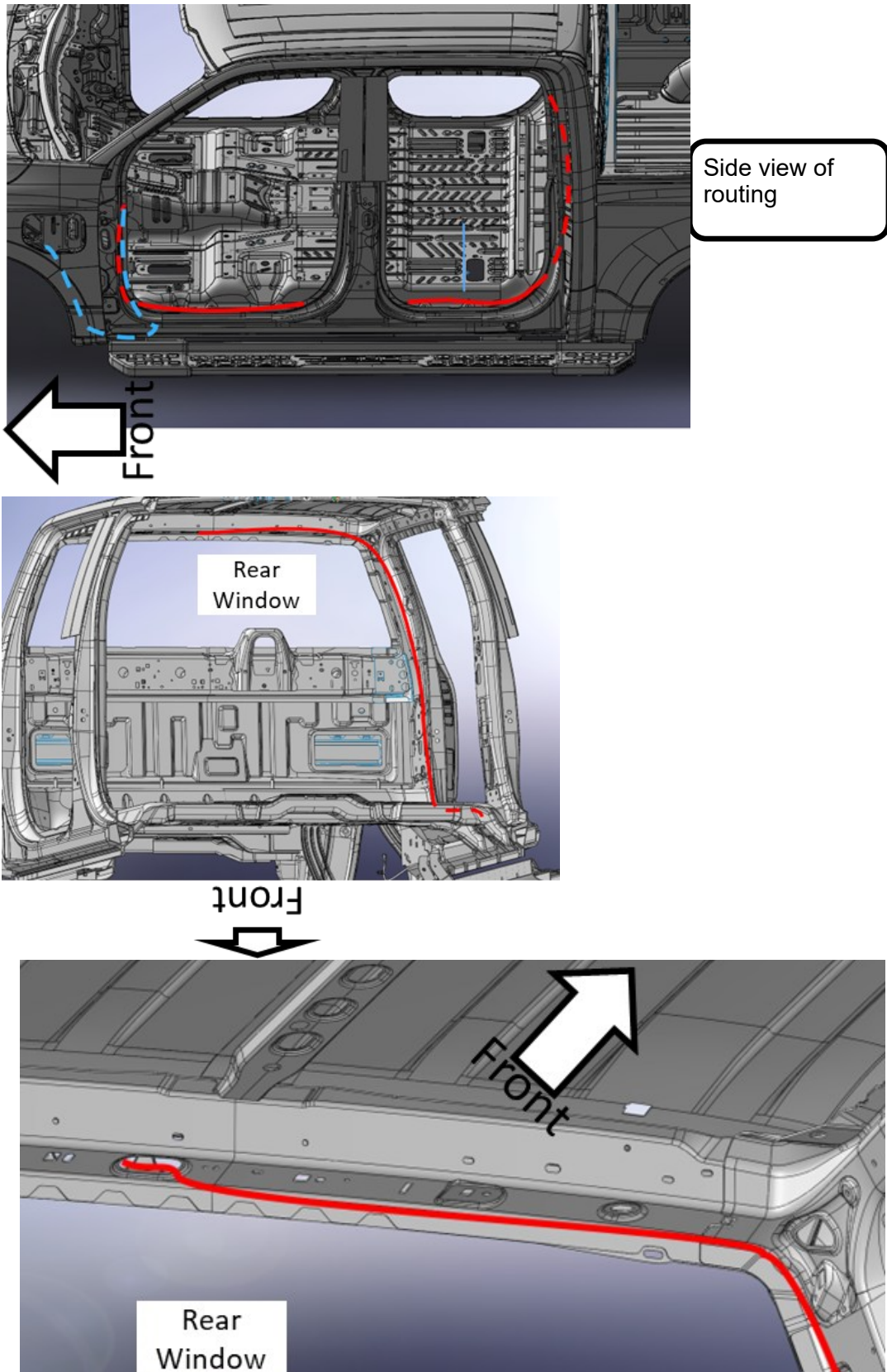

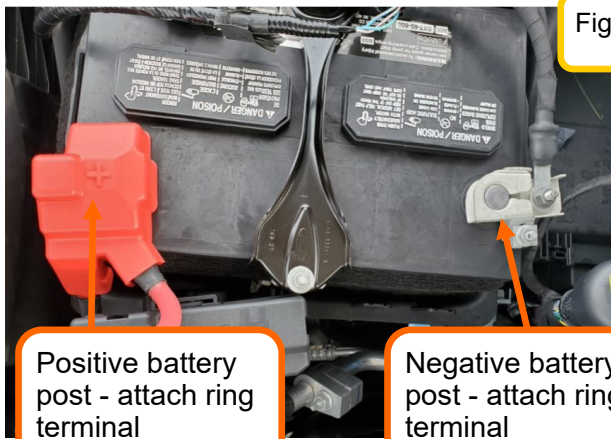

Figure 8.1

Step 1: Locate the power harness #67095.

Remove the fuse from the inline fuse holder until the end of the install

Locate the OEM battery under the hood.

Step 2:

Attach the red wire with the ring terminal to the battery positive post.

Attach the black wire with the ring terminal to the battery negative post.

Figure 8.1.

Route the white connector end along the underside of the cab filter (see figure 8.2 red dotted line) to the firewall. (You can tuck the wiring under the filter and hide it. Figure 8.3.)

Step3:

Locate the firewall grommet from underneath the kick panel inside the cab on the driver's side.

Figure 8.4.

Drill a hole (to fit the grommet on the power harness) to the right of BOTH OEM grommets, like shown in figure 8.5.

****BE SURE TO CHECK THAT THE OPPOSING SIDE OF THE FIREWALL IS CLEAR BEFORE DRILLING.****

Route the white connector end through the firewall and insert the grommet on the sheet metal. Make sure to leave a drip loop.



Figure 8.2



Figure 8.3

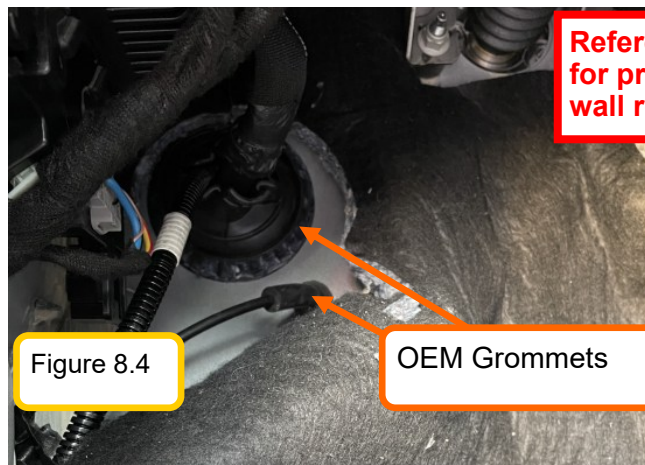

Figure 8.4

OEM Grommets

Reference Pg. 3 for proper fire-wall routing.



Figure 8.5

ASCO Harness/Grommet

Power harness

Switch Harness



Figure 9.1

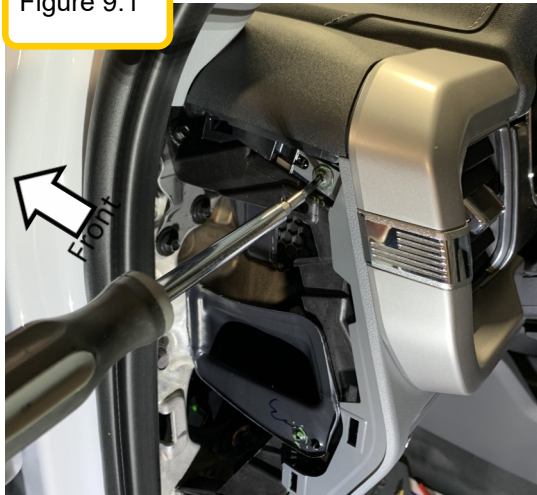
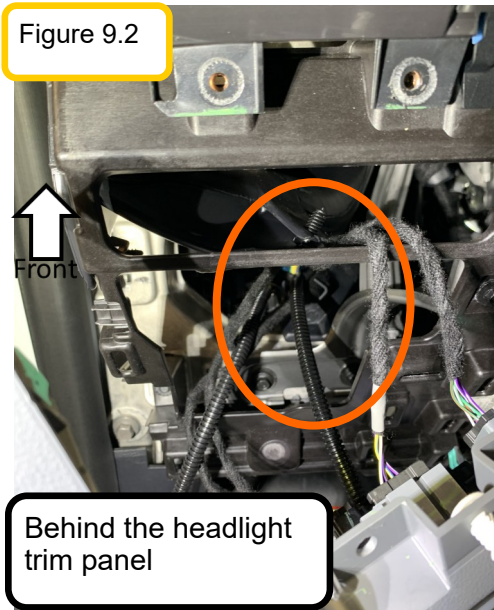

Figure 9.2



Behind the headlight trim panel

Switched power
12V Constant
Ground



Step 4: Locate the switch harness #67097

Connect the switch harness connector to the power harness in the kick panel area.

Disassemble the IP trim to gain access behind the dash. Figure 9.1.

Route the switch end of the switch harness up the dash and through the opening in the IP. Figure 9.2.

Secure to the OEM harnesses behind the IP.

Step 5: Drill a hole for the switch, in the trim panel like shown below.

The hole will be centered in the unused square box above the Emergency brake button. If this spot is un-attainable, move the switch to the right, where it can be located. Be sure the back side of the trim panel is open before drilling the hole. Figure 9.3.

Route the harnesses through the hole

Step 6: Connect the ground spade to the gold pin on the rocker switch

Connect the white battery power spade to the opposite terminal on the switch.

Connect the red spade to the middle pin

Insert the switch into the hole and place the strobe/beacon decal (if supplied) around the switch. Reassemble all trim and secure wiring.

Figure 9.3

Switch location preferred.

If not attainable, move to the right.

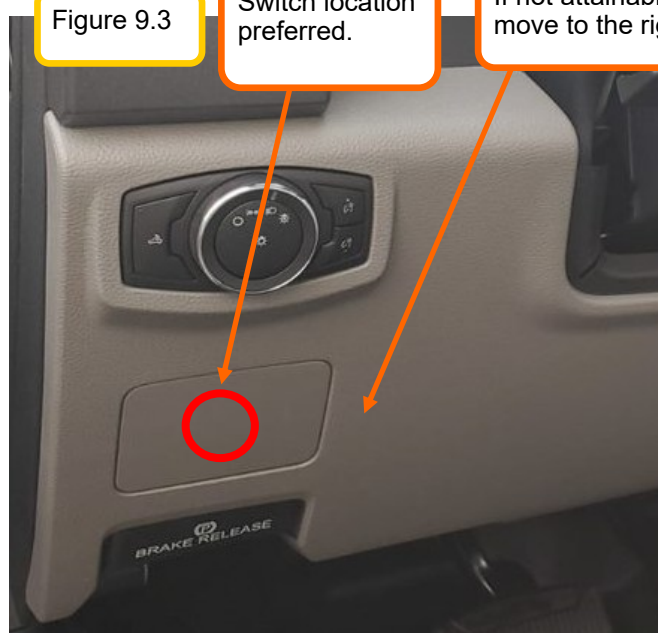

Strobe Install—If Applicable

Strobe pictures are for reference only. Please refer to product structure/spec sheets for the actual strobes for the install.

Figure 10.1



Step 1:

Locate the rear strobe harness #67108.

Connect the rear strobe harness to the switch harness (one of the remaining unused connectors) in the driver's foot well. Figure 10.1.

Step 2:

Locate the driver's side door sill area. Figure 10.2.

Use a trim tool to remove the trim panels in the driver's step well and dash/kick panel.

Locate the OEM grommets under the carpet. There will be one right next to the foot sill area and one to the right closer to the driver's seat.

The front strobes will use the one closest to the foot sill and the rear strobes will use the grommet closest to the driver's seat.

Figure 10.3 and 10.4.

Cut an "X" in the grommet. Route the rear strobe harness through the grommet (by the seat) to the underneath of the vehicle.

Silicone the grommet when done.

Figure 10.2

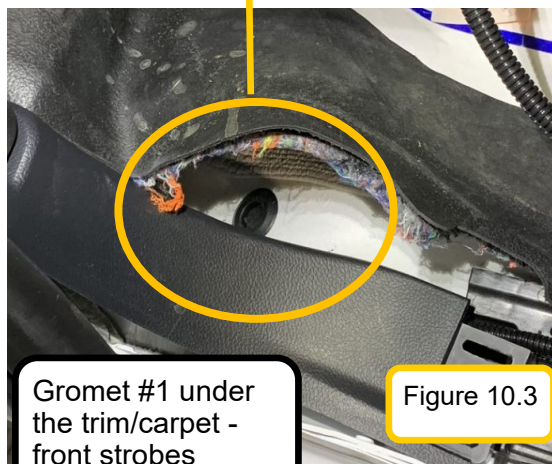
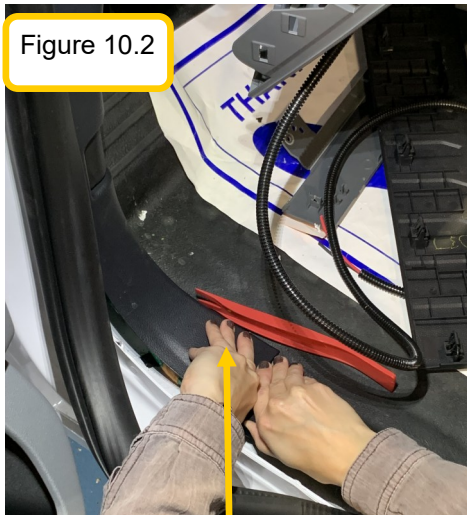

Grommet #1 under the trim/carpet - front strobes

Figure 10.3

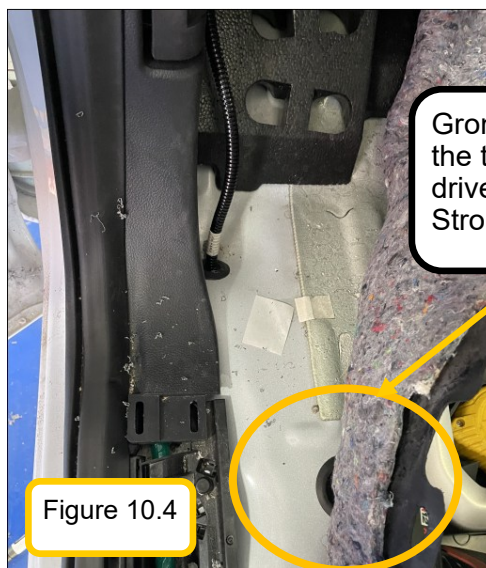

Grommet #2 under the trim/carpet - drivers seat (rear Strobes)

Figure 10.4

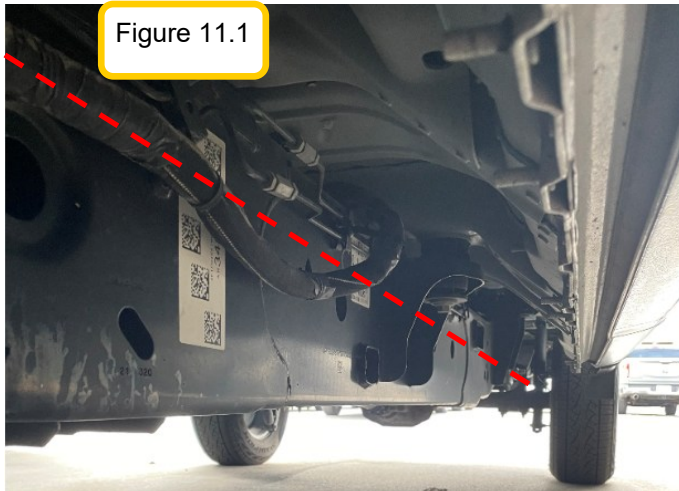

Figure 11.1

Step 3: Routing (Refer to routing diagrams at the beginning of the instructions)

Route the strobe harness rearward following the frame (red dotted line). Secure with zip ties to the OEM harness. Figure 11.1 and 11.2.

Step 4: Mounting Strobes

Find the left most reverse sensor.

Place the strobes in line with the sensor horizontally (about 1" down from the bumper crease) and 1" over from the sensor. Figure 11.3.

If truck does not have the sensor, measure from the left most edge of the bumper.

Use the strobe as a template, mark the center hole location on the bumper (for routing the wires through).

Drill a 3/8" hole for the wire pass through of the strobe. Use primer on the hole to prevent rusting. Figure 11.3.

Connect the strobe light to the harness and silicone the hole.

Place the strobes in their desired locations and fasten them onto the bumper with the **ASCO SUPPLIED SCREW AND NUT: FAS0501 and FAS0503 (for rear bumper only—front will use Ecco supplied screws)**

Figure 11.4 is a F150 for reference only. Repeat the F250 as close as possible to this reference.

*****TORQUE STROBES TO 10-IN-LB'S MAXIMUM*****

Repeat for the right side strobe.



Figure 11.2

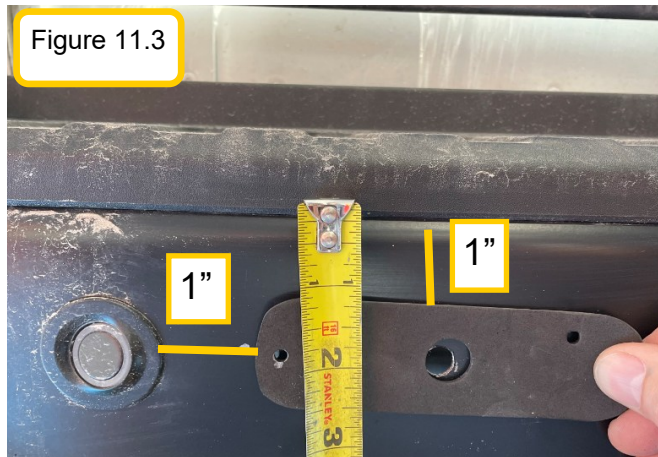

Figure 11.3



Figure 11.4

Figure 12.1



Measure 1" left of here and place along dashed line (the contour).

Step 7: Mounting Front Strobes

Locate the left front headlight area.

Measure 1" left of the edge of the bumper. Place the right edge of the strobe on the 1" mark and in line the bumper contour. Figure 12.1.

Use the strobe as a template, mark the center hole location on the panel (for routing the wires through).

Drill a 3/8" hole for the wire pass through on the strobe. Figure 12.2.

Figure 12.2

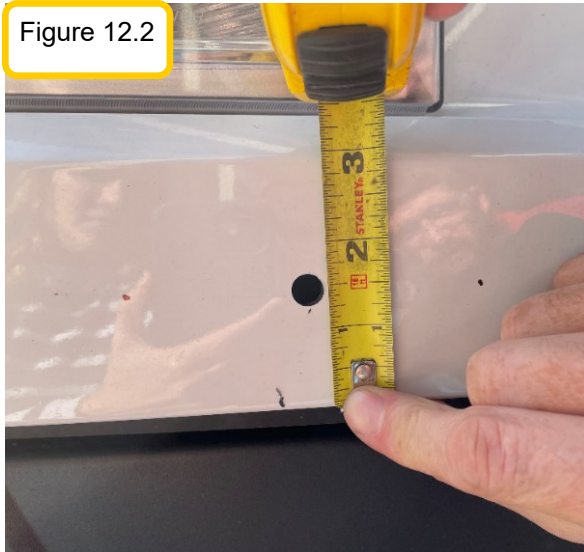

Place the strobes in their desired locations and fasten them onto the grill with the supplied screws. Figure 12.3.

*****TORQUE STROBES TO 10-IN-LB'S MAXIMUM*****

Repeat for the other side strobe.

Note that if the truck comes with running lights, place the strobes below them. Figure 12.4 for reference.

Figure 12.3



Figure 12.4

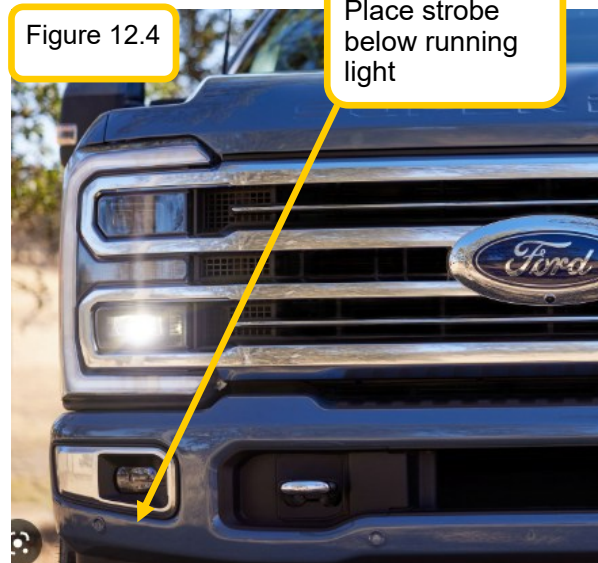



Figure 14.1

Point of view in pictures: Laying under the front bumper looking up toward the backside of the bumper

Step 5: Locate the front strobe harness #67104.

Start by placing the harness strobe ends at each strobe location, beneath the vehicle.

Connect the passenger side strobe to the harness. Then follow the OEM harness that runs beneath the grill over the driver's side. Zip tie the harness to the OEM harness. See figure 14.1 for routing.

Note: You can best see the OEM harness and routing by laying under the vehicle front the front end.

Be sure not to secure or route the harness anywhere near moving or hot objects.

Connect the second connector to the driver's side strobe.



Figure 14.2

End to route through the OEM grommet—front strobe harness

Grommet: Cab view
Also, strobe harness connected to switch

Step 6:

Start by routing the inside connector end of the harness to the firewall. Figure 14.2.

Locate the grommet by the driver's foot sill in the cab area (found previously on page 11)

Route the harness down to the underneath of the vehicle, following the OEM harnesses.

Cut and X in the grommet and route the connector through. Figure 14.3.

Connect the front strobe harness to the switch harness (one of the remaining unused connectors) in the driver's foot well. Figure 14.4.

Secure wiring with zip ties. Silicone the grommet. Figure 14.5.

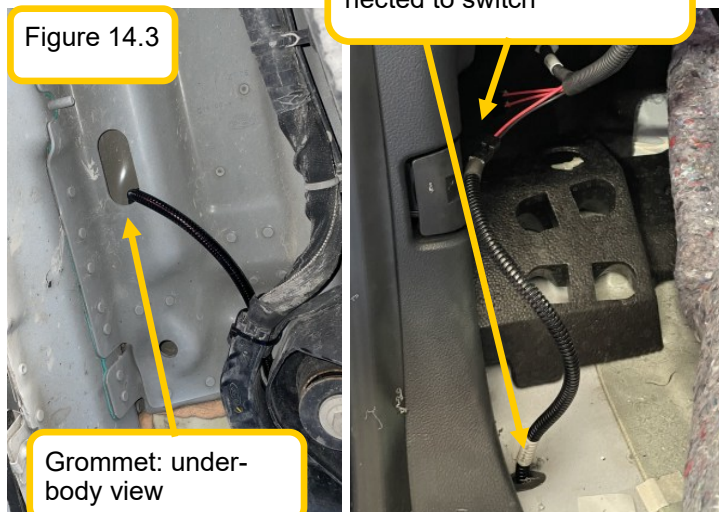

Figure 14.3

Grommet: under-body view

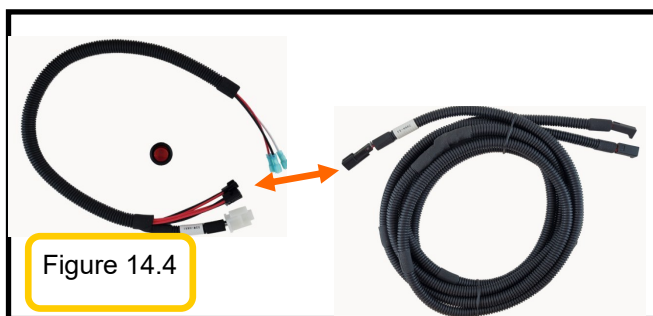

Figure 14.4

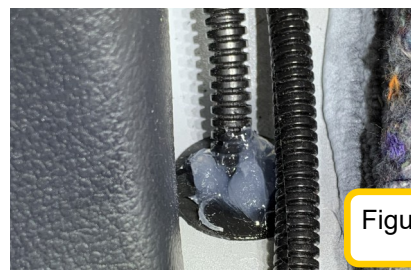
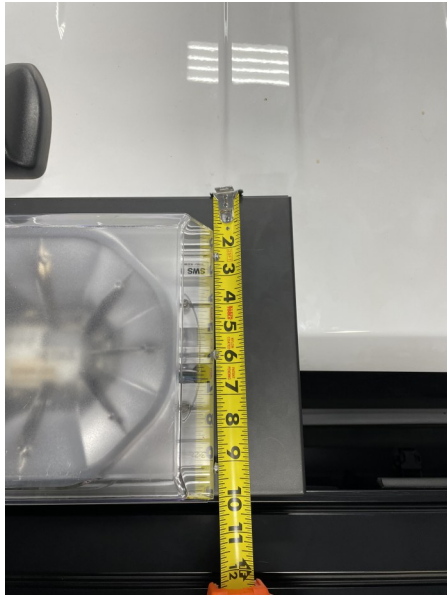

Figure 14.5

Beacon/Lightbar Install—If Applicable

Lightbar/ beacon/ and mount pictures are for reference only. Please refer to product structure/ spec sheets for the actual beacon/lightbar/mount for the install.



Step 1: On a table/bench: Assemble the light
Assemble the lightbar or beacon to the mount, using the supplied fasteners and rubber spacers with the lightbar.

If installing a Whelen lightbar, use the provided screws (FAS0869), washers (FAS0871), and nuts (FAS0501) in the ASCO kit. They are not provided with the light.
All other lights will have their own hardware.

Note: Lightbar (SWS Apollo) in pictures is for reference only.

Center the lightbar or beacon onto the mount, side to side, then slide the lightbar to the rear of the mount until it is flush. See pictures for reference.

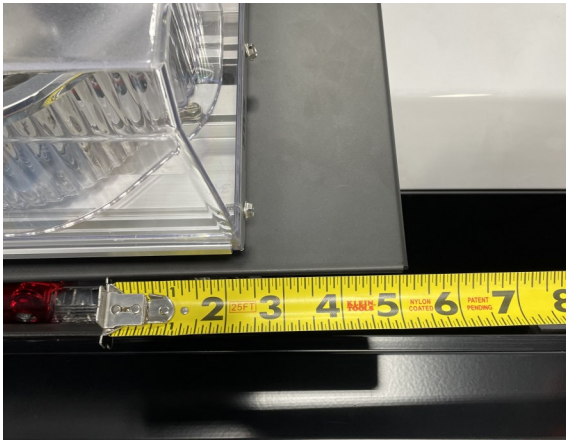

Use the lightbar/beacon as template, mark the needed holes for mounting. Drill the needed holes for mounting.

Drill the hole for the wiring pass through and insert the provided grommet (if applicable).

Silicone the grommet/pass thru wiring.

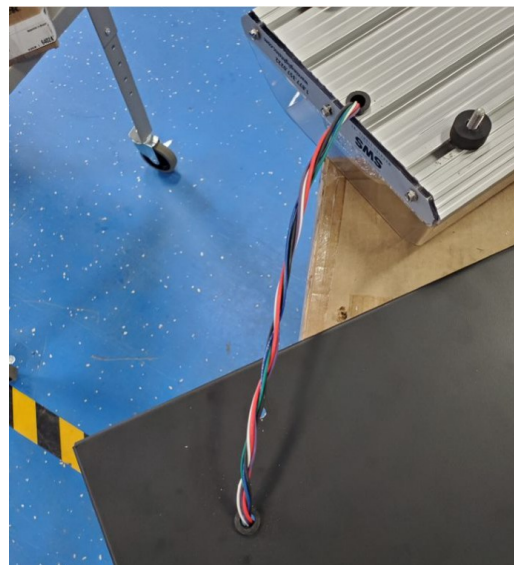
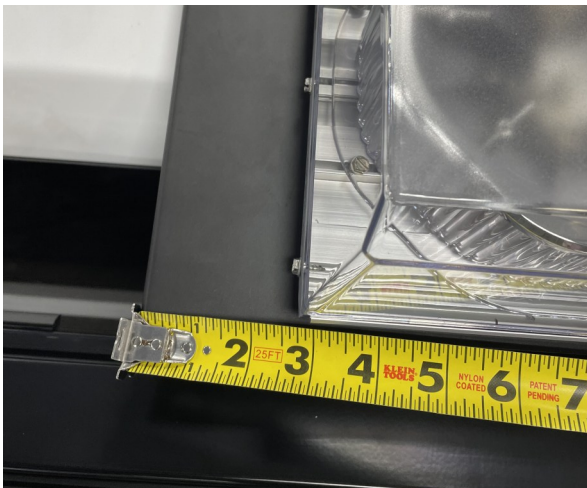



Figure 15.1

Pictures to the left are for beacon/lightbar mounting references.
Figure 15.1, 15.2, and 15.3



Figure 15.3



Figure 15.2

Step 2: Disconnect OEM Light

Using a torx T20 bit, remove the 4 screws holding the 3rd brake light to the CHMSL. Figure 15.4.

Remove the OEM light from the CHMSL and disconnect the OEM harness clip. Figure 15.5.

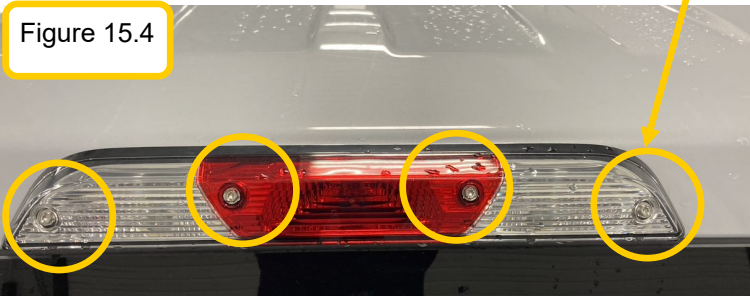

Figure 15.4

Step 3:

Locate the beacon/lightbar harness (67113).

Remove the cable gland off the beacon/lightbar harness. This will not be needed to the CHMSL mounted light install.

Connect the harness to the switch harness (one of the remaining unused connectors) in the driver's foot well. Figure 15.6.



Figure 15.5

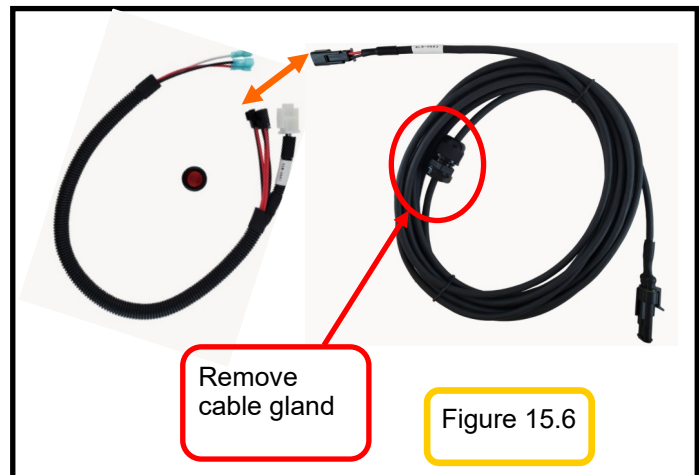

Remove cable gland

Figure 15.6

Beacon/Lightbar Install—If Applicable

Step 4: Routing (Refer to routing diagrams at the beginning of the instructions)

Route the beacon harness following the OEM harness rearward along the foot sill and then up the rear C pillar. Figure 16.1 and 16.2.

****BE SURE TO AVOID ALL SEAT BELT RETENTIONERS****

Step 5: Feed the fish tape through the CHMSL opening towards the driver's side C pillar. Tape the harness to the fish tape and pull through the CHMSL opening. Figure 16.3.

Make sure harness is tucked head liner and C pillar trim. Figure 16.4.

See pictures for routing references. Secure all wiring with cable ties and trim panels.

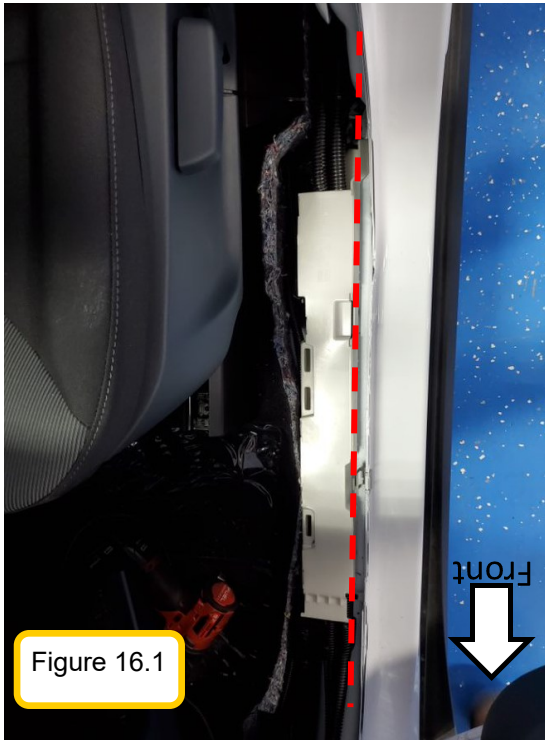
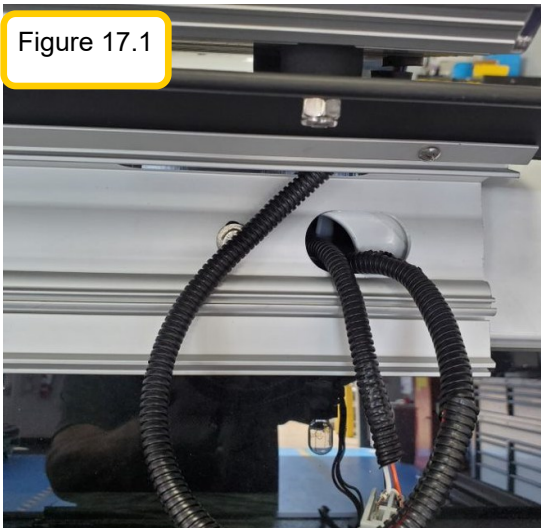

Figure 17.1



Step 5: Mounting the light:

Using the mount manufacturer supplied instructions, attach the mount to the vehicle body.

Pull the lightbar harness through the mount opening like seen in the picture to the left—before re-installing the OEM light and black trim plastic piece. Figure 17.1, 17.2, and 17.3.

Connect the beacon/lightbar harness with the beacon/lightbar.

Figure 17.2

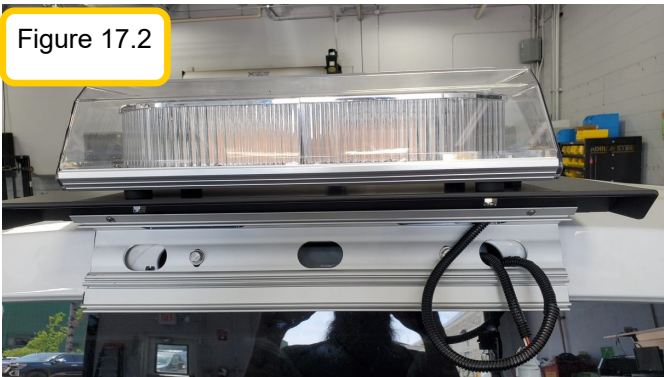

Tape up all non-needed wires from the lightbar/beacon.

Assemble the rest of the needed lightbar/beacon mount pieces.

Re-connect all the OEM light wiring and attach the light back to the Acari mount/vehicle. Figure 17.4.

Figure 17.3



Figure 17.4





Insert the fuse into the inline-fuse holder on the power harness. The install is now complete. Secure all wiring with zip ties. Re-attach all trim. Re-assure all pass through holes have been silicone. Double check the functionality of the lights and switches.

PART NUMBER

13905-0

ITEM DESCRIPTION: WIRE TIE, NYLON 40Lb, 8.5" BLACK



MANUFACTURER: WAYTEK, INC. or equivalent
MANUFACTURERS PART NUMBER: 21093M or 21093C

SPECIFICATIONS: STANDARD CABLE TIE
BLACK, NYLON
8-1/2" LONG
TENSILE STRENGTH: 40.0 LBS
21093M = 1,000 quantity
21093C = 100 quantity

SPECIAL NOTES: PART NUMBER IS BLACK.

SUPPLIED BY: THIS ITEM IS ADRIAN AVAILABLE!

PURCHASED PRODUCT DATA SHEET (PPDS)

THIS DRAWING/INFORMATION IS THE PROPERTY OF ADRIAN STEEL COMPANY AND IS NOT TO BE USED IN ANY MANNER THAT IS DETRIMENTAL TO THE INTEREST OF ADRIAN STEEL. COPYRIGHTS AND OR PATENTS THAT MAY BE THE PROPERTY OF APPLICABLE OWNERS MAY PROTECT INFORMATION AND/OR DRAWINGS OF SUPPLIED PRODUCTS.



ADRIAN STEEL
VAN AND PICKUP EQUIPMENT

906 JAMES STREET
ADRIAN, MI 49221
517-265-6194
WWW.ADRIANSTEEL.COM



WHEN INSTALLING EQUIPMENT IN OR ON VEHICLES CHECK FOR FUEL TANKS, FUEL LINES, CONTROL LINES AND ELECTRICAL WIRING BEFORE DRILLING! ALWAYS USE DRILL BITS WITH INTEGRAL STOPS WHENEVER POSSIBLE!

DRAWN BY
MDG

DATE DRAWN
10/26/2006

ECN NUMBER
18021

ECN DATE
11/13/2015

PART WEIGHT
0.01 LBS.

REV. LEVEL
D

PART NUMBER
13905-0

PART NUMBER

26618-0

ITEM DESCRIPTION: SILICONE, 1oz. TUBE



SPECIFICATIONS: SU5005 RTV SILICONE
1oz. TUBE
CLEAR OR EQUIVALENT
SELF PIERCING CAP

SPECIAL NOTES:

SUPPLIED BY: THIS ITEM IS ADRIAN AVAILABLE!

PURCHASED PRODUCT DATA SHEET (PPDS)

THIS DRAWING/INFORMATION IS THE PROPERTY OF ADRIAN STEEL COMPANY AND IS NOT TO BE USED IN ANY MANNER THAT IS DETRIMENTAL TO THE INTEREST OF ADRIAN STEEL. COPYRIGHTS AND OR PATENTS THAT MAY BE THE PROPERTY OF APPLICABLE OWNERS MAY PROTECT INFORMATION AND/OR DRAWINGS OF SUPPLIED PRODUCTS.



ADRIAN STEEL
VAN AND PICKUP EQUIPMENT

906 JAMES STREET
ADRIAN, MI 49221
517-265-6194

WWW.ADRIANSTEEL.COM

CAUTION

WHEN INSTALLING EQUIPMENT IN OR ON VEHICLES CHECK FOR FUEL TANKS, FUEL LINES, CONTROL LINES AND ELECTRICAL WIRING BEFORE DRILLING! ALWAYS USE DRILL BITS WITH INTEGRAL STOPS WHENEVER POSSIBLE!

DRAWN BY
JLC

DATE DRAWN
7/21/2001

ECN NUMBER
16551

ECN DATE
7/22/2014

PART WEIGHT
0.02 LBS.

REV. LEVEL
C

PART NUMBER
26618-0

PART NUMBER

26618-0

ITEM DESCRIPTION: SILICONE, 1oz. TUBE



SPECIFICATIONS: SU5005 RTV SILICONE
1oz. TUBE
CLEAR OR EQUIVALENT
SELF PIERCING CAP

SPECIAL NOTES:

SUPPLIED BY: THIS ITEM IS ADRIAN AVAILABLE!

PURCHASED PRODUCT DATA SHEET (PPDS)

THIS DRAWING/INFORMATION IS THE PROPERTY OF ADRIAN STEEL COMPANY AND IS NOT TO BE USED IN ANY MANNER THAT IS DETRIMENTAL TO THE INTEREST OF ADRIAN STEEL. COPYRIGHTS AND OR PATENTS THAT MAY BE THE PROPERTY OF APPLICABLE OWNERS MAY PROTECT INFORMATION AND/OR DRAWINGS OF SUPPLIED PRODUCTS.



ADRIAN STEEL
VAN AND PICKUP EQUIPMENT

906 JAMES STREET
ADRIAN, MI 49221
517-265-6194

WWW.ADRIANSTEEL.COM

! CAUTION !

WHEN INSTALLING EQUIPMENT IN OR ON VEHICLES CHECK FOR FUEL TANKS, FUEL LINES, CONTROL LINES AND ELECTRICAL WIRING BEFORE DRILLING! ALWAYS USE DRILL BITS WITH INTEGRAL STOPS WHENEVER POSSIBLE!

DRAWN BY
JLC

DATE DRAWN
7/21/2001

ECN NUMBER
16551

ECN DATE
7/22/2014

PART WEIGHT
0.02 LBS.

REV. LEVEL
C

PART NUMBER
26618-0

PART NUMBER

36096-0

ITEM DESCRIPTION: GROMMET,RUBBER,1" ID

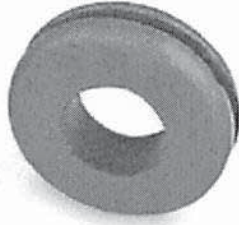

MANUFACTURER: CTW (or equiv.)
MANUFACTURERS PART NUMBER: G2930

SPECIFICATIONS: 1" I.D.
1-1/4" PANEL HOLE DIA.
3/16" MAX PANEL THICKNESS
1-1/2" O.D.
7/16" THICKNESS

SPECIAL NOTES: NONE

SUPPLIED BY: THIS ITEM IS ADRIAN AVAILABLE!

PURCHASED PRODUCT DATA SHEET (PPDS)

THIS DRAWING/INFORMATION IS THE PROPERTY OF ADRIAN STEEL COMPANY AND IS NOT TO BE USED IN ANY MANNER THAT IS DETRIMENTAL TO THE INTEREST OF ADRIAN STEEL. COPYRIGHTS AND OR PATENTS THAT MAY BE THE PROPERTY OF APPLICABLE OWNERS MAY PROTECT INFORMATION AND/OR DRAWINGS OF SUPPLIED PRODUCTS.



ADRIAN STEEL
VAN AND PICKUP EQUIPMENT

906 JAMES STREET
ADRIAN, MI 49221
517-265-6194

WWW.ADRIANSTEEL.COM

CAUTION

WHEN INSTALLING EQUIPMENT IN OR ON VEHICLES CHECK FOR FUEL TANKS, FUEL LINES, CONTROL LINES AND ELECTRICAL WIRING BEFORE DRILLING! ALWAYS USE DRILL BITS WITH INTEGRAL STOPS WHENEVER POSSIBLE!

DRAWN BY
HJE

DATE DRAWN
04/01/2008

ECN NUMBER
19252

ECN DATE
01/31/2017

PART WEIGHT
0.01 LBS.

REV. LEVEL
D

PART NUMBER
36096-0

ITEM DESCRIPTION: NO DRILL PLATFORM, FORD FSPU, LOW PROFILE

MANUFACTURER: ACARI

MANUFACTURERS PART NUMBER: RTM-101-LP-FORD

SPECIFICATIONS: 22" Low Profile no drill mount for beacons and lightbars

SPECIAL NOTES: 2015+ Ford F-150 and 2017+ Ford F250/350 Pickups only.

SUPPLIED BY: THIS ITEM IS ADRIAN AVAILABLE!**PURCHASED PRODUCT DATA SHEET (PPDS)**

Page 1 of 1

THIS DRAWING/INFORMATION IS THE PROPERTY OF ADRIAN STEEL COMPANY AND IS NOT TO BE USED IN ANY MANNER THAT IS DETRIMENTAL TO THE INTEREST OF ADRIAN STEEL. COPYRIGHTS AND OR PATENTS THAT MAY BE THE PROPERTY OF APPLICABLE OWNERS MAY PROTECT INFORMATION AND/OR DRAWINGS OF SUPPLIED PRODUCTS.

**ADRIAN STEEL**

Cargo Management Solutions for Commercial Vehicles

906 JAMES STREET
ADRIAN, MI 49221
517-265-6194

WWW.ADRIANSTEEL.COM

**CAUTION**

WHEN INSTALLING EQUIPMENT IN OR ON VEHICLES CHECK FOR FUEL TANKS, FUEL LINES, CONTROL LINES AND ELECTRICAL WIRING BEFORE DRILLING! ALWAYS USE DRILL BITS WITH INTEGRAL STOPS WHENEVER POSSIBLE!

DRAWN BY
RBBDATE DRAWN
10/04/2016ECN NUMBER
19221ECN DATE
01/27/2017PART WEIGHT
3.00 LBS.REV. LEVEL
C

PART NUMBER

52769

ITEM DESCRIPTION: STROBE SWITCH DECAL SET

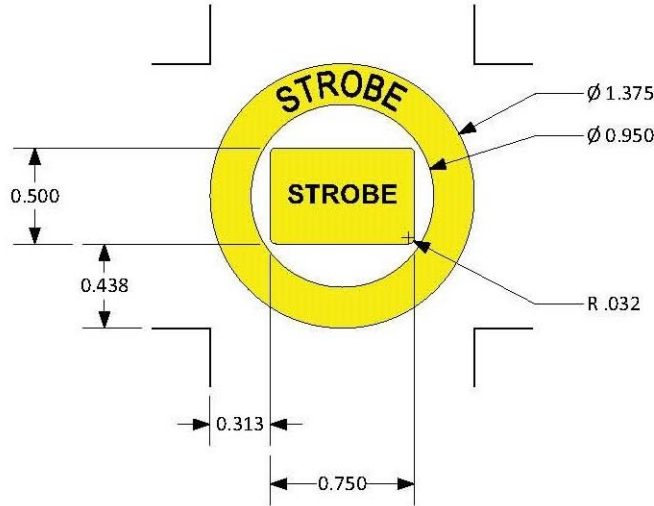

MANUFACTURER: VANNER
MANUFACTURERS PART NUMBER: TBD

SPECIFICATIONS: (1) Circular Yellow Decal (ID=0.950", OD=1.375") with "STROBE" in black letters
(1) Rectangular Yellow Decal (H=0.500", L=0.750") with "STROBE" in black letters

SPECIAL NOTES: For round rocker switch (OD=0.780") and Ford Transit Upfitter Switches.

SUPPLIED BY: THIS ITEM IS ADRIAN AVAILABLE!

PURCHASED PRODUCT DATA SHEET (PPDS)

THIS DRAWING/INFORMATION IS THE PROPERTY OF ADRIAN STEEL COMPANY AND IS NOT TO BE USED IN ANY MANNER THAT IS DETRIMENTAL TO THE INTEREST OF ADRIAN STEEL. COPYRIGHTS AND OR PATENTS THAT MAY BE THE PROPERTY OF APPLICABLE OWNERS MAY PROTECT INFORMATION AND/OR DRAWINGS OF SUPPLIED PRODUCTS.



**906 JAMES STREET
ADRIAN, MI 49221
517-265-6194
WWW.ADRIANSTEEL.COM**



CAUTION
WHEN INSTALLING EQUIPMENT IN OR ON VEHICLES CHECK FOR FUEL TANKS, FUEL LINES, CONTROL LINES AND ELECTRICAL WIRING BEFORE DRILLING! ALWAYS USE DRILL BITS WITH INTEGRAL STOPS WHENEVER POSSIBLE!

DRAWN BY RJB	DATE DRAWN 11/15/2017
ECN NUMBER XXXX	ECN DATE XXXXXX
PART WEIGHT 0.02 LBS.	REV. LEVEL A
PART NUMBER 55073	

REVISIONS		
REV	DESCRIPTION	DATE

- NOTES:
1. MATERIAL : .002 YELLOW POLYESTER
 2. ARTWORK FROM D91XXXX-A PAGE 1, PMS BLACK
 3. .001 OVERLAMINATE
 4. ADHESIVE BACKED

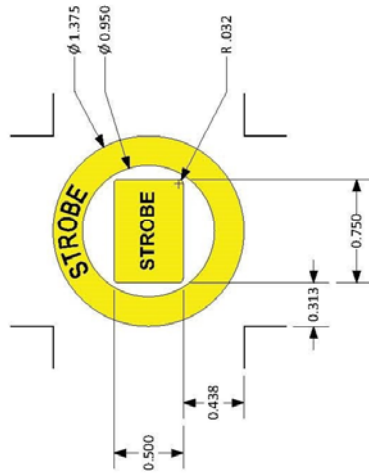

		HILLIARD, OHIO USA	
TOL. LABEL/METAL	.x ± .025 .xx ± .015 .xxx ± .005	REAE/CO NO.:	XXXX
TOL. CABLES	.xxx ± .25	THIS DRAWING AND ALL INFORMATION CONTAINED HEREIN IS THE PROPERTY OF VANNER INC. AND MAY NOT BE COPIED, REPRODUCED OR DIVULGED TO UNAUTHORIZED PERSONS WITHOUT THE EXPRESS WRITTEN CONSENT OF VANNER INC. IT IS PROVIDED SOLELY FOR THE CONVENIENCE OF THE USER AND SHALL BE RETURNED UPON REQUEST.	
DRN/DATE	MEO 11/14/17	CHK/DATE	XXX XXXXXX
TITLE:		DRAWING/ PART NO.	REV
LABEL, STROBE TXT, .95ID ROUND SWITCH		D01XXXX	SHEET 1 OF 1 REV A

THIS DRAWING/INFORMATION IS THE PROPERTY OF ADRIAN STEEL COMPANY AND IS NOT TO BE USED IN ANY MANNER THAT IS DETRIMENTAL TO THE INTEREST OF ADRIAN STEEL. COPYRIGHTS AND OR PATENTS THAT MAY BE THE PROPERTY OF APPLICABLE OWNERS MAY PROTECT INFORMATION AND/OR DRAWINGS OF SUPPLIED PRODUCTS.



906 JAMES STREET
ADRIAN, MI 49221
517-265-6194
WWW.ADRIANSTEEL.COM



WHEN INSTALLING EQUIPMENT IN OR ON VEHICLES CHECK FOR FUEL TANKS, FUEL LINES, CONTROL LINES AND ELECTRICAL WIRING BEFORE DRILLING! ALWAYS USE DRILL BITS WITH INTEGRAL STOPS WHENEVER POSSIBLE!

DRAWN BY RJB	DATE DRAWN 11/15/2017
ECN NUMBER XXXX	ECN DATE XXXXXXX
PART WEIGHT 0.02 LBS.	REV. LEVEL A
PART NUMBER 55073	

PART NUMBER
55073

LOC | QTY | Part # | Description | Size

Material: IJ39 | Lamination: 8518

- 1: 6039597.Strobe Switch-1.52" x 2.07"



Note: Part will not be weeded, just cut.

Kit# 8001872 | Adrian Steel Part # 55073

06/01/2023 • JY
© 2022 DISTYLL Graphics Solutions. All rights reserved.

ASCO REV.1 6/14/2023

<p>DISTYLL GRAPHIC SOLUTIONS</p> <p>FINAL DESIGN</p>	CLIENT NAME:		Switch Decals		O-ID: O15319-1
	Adrian Steel				
	DATE:	DESIGNER:	TRN		

Please check information to confirm accurate vehicle specifications.

CLEANING INSTRUCTIONS All surfaces must be considered contaminated. Clean the vehicle surface immediately before applying the film. Dust and other contaminants can collect quickly on the surface and prevent the film from adhering properly. Even a freshly painted surface can collect dust before graphics can be applied.

For the best success with the films recommended for vehicle graphics, always apply the graphics when the air and vehicle surface are both above 60°F (16°C) and below 90°F (32°C) before beginning the installation.

PURCHASED COMPONENT KEY FEATURES

DESCRIPTION OF REQUIREMENTS

DIMENSIONAL REQUIREMENTS (AS SHOWN ON DRAWING)

N/A

LOAD/RATING REQUIREMENT

N/A

MATERIAL REQUIREMENT

N/A

PACKAGING REQUIREMENT

N/A

OTHER REQUIREMENTS

Note:
This is also from HellermannTyton:
Their Part Number is 156-00592



THIS DRAWING IS THE PROPERTY OF ADRIAN STEEL COMPANY AND IS NOT TO BE USED IN ANY MANNER DETRIMENTAL TO THE INTERESTS OF ADRIAN STEEL COMPANY

TOLERANCES & INSPECTION

UNLESS OTHERWISE SPECIFIED

ALL BEND ANGLES ARE 90 DEGREES

ALL DIMENSIONS ARE IN INCHES.

REFERENCE DIMENSIONS (X.XXX)
DO NOT REQUIRE INSPECTION

FEATURES	HOLES/SLOTS	ANGLES
0.0 = ± .125	0.0 = ± .062	0° = ± 2°
0.00 = ± .062	0.00 = ± .031	0.0° = ± 1°
0.000 = ± .031	0.000 = ± .015	

Material Thickness: per ASTM Std.
Weld Callouts per AWS

RELEASE & REVISIONS

INITIAL ECN: **22671**

CURRENT ECN: **22671**

ECN DESCRIPTION:

RELEASE TO PRODUCTION

REVISED BY: **EMS**

PURCHASED COMPONENT

REFERENCED SUPPLIER AND/OR MANUFACTURER

Fastenal

REFERENCED SUPPLIER AND/OR MANUFACTURER PART NUMBER

0787863

COLOR (ONLY LIST IF COLOR SPECIFIC)

COMODITY ITEM (Y/N) (YES = ALL DIMENSIONS AND NOTES ARE REFERENCE)
(NOTE: DIMENSIONS AND FEATURES MAY VARY FOR A COMODITY ITEM.)

NO

PRINTED DOCUMENT IS UNCONTROLLED

Sheet 1 of 1

PART / PRODUCT IDENTIFICATION



ADRIAN STEEL®

ADRIAN STEEL COMPANY
906 JAMES STREET, ADRIAN, MI 49221

REVISION LEVEL

A

MAT'L USED:

DESIGNED BY: **EMS**

DESCRIPTION:

Clip, Black UV Tie, HellermannTyton

WEIGHT (Lbs.): **0.5**

SEGMENT CODE: **ELE**

PART NUMBER: **59713**

PURCHASED COMPONENT KEY FEATURES

DESCRIPTION OF REQUIREMENTS

DIMENSIONAL REQUIREMENTS (AS SHOWN ON DRAWING)

N/A

LOAD/RATING REQUIREMENT

N/A

MATERIAL REQUIREMENT

N/A

PACKAGING REQUIREMENT

N/A

OTHER REQUIREMENTS



THIS DRAWING IS THE PROPERTY OF ADRIAN STEEL COMPANY AND IS NOT TO BE USED IN ANY MANNER DETRIMENTAL TO THE INTERESTS OF ADRIAN STEEL COMPANY

PRINTED DOCUMENT IS UNCONTROLLED

Sheet 1 of 1

TOLERANCES & INSPECTION

UNLESS OTHERWISE SPECIFIED

ALL BEND ANGLES ARE 90 DEGREES

ALL DIMENSIONS ARE IN INCHES.

REFERENCE DIMENSIONS (X.XXX)
DO NOT REQUIRE INSPECTION

FEATURES	HOLES/SLOTS	ANGLES
0.0 = ± .125	0.0 = ± .062	0° = ± 2°
0.00 = ± .062	0.00 = ± .031	0.0° = ± 1°
0.000 = ± .031	0.000 = ± .015	

Material Thickness: per ASTM Std.
Weld Callouts per AWS

RELEASE & REVISIONS

INITIAL ECN: **25378**

CURRENT ECN: **25378**

ECN DESCRIPTION:

RELEASE FOR PRODUCTION

REVISED BY:

PURCHASED COMPONENT

REFERENCED SUPPLIER AND/OR MANUFACTURER

AAMP GLOBAL

REFERENCED SUPPLIER AND/OR MANUFACTURER PART NUMBER

67095 OR PWR-HAR4

COLOR (ONLY LIST IF COLOR SPECIFIC)

COMODITY ITEM (Y/N) (YES = ALL DIMENSIONS AND NOTES ARE REFERENCE)
(NOTE: DIMENSIONS AND FEATURES MAY VARY FOR A COMODITY ITEM.)

NO

PART / PRODUCT IDENTIFICATION



ADRIAN STEEL

ADRIAN STEEL COMPANY
906 JAMES STREET, ADRIAN, MI 49221

REVISION LEVEL

A

MAT'L USED: **PURCHASED**

DESIGNED BY: **E.BURKE**

DESCRIPTION: **POWER HARNESS EXTERIOR 4**

WEIGHT (Lbs.): **0.2**

SEGMENT CODE: **ELE**

PART NUMBER: **67095**

Coverings	
Id	Assembly
[7]	
[8]	

Notes	
①	Lock Tape Loom with Tesa 51036
②	Add 15A Mini Fuse
③	Add rubber grommet over harness loom; 150mm behind C2

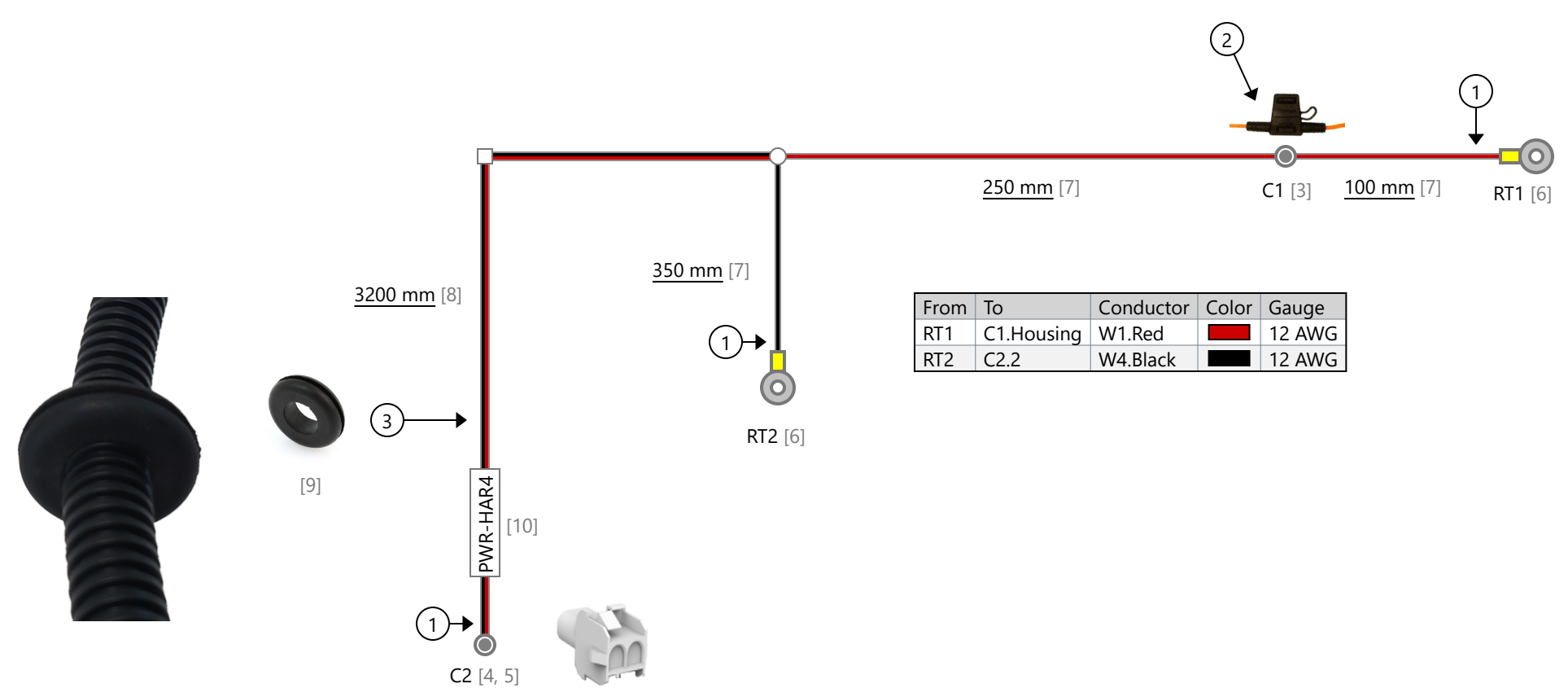

From	To	Conductor	Color	Gauge
RT1	C1.Housing	W1.Red		12 AWG
RT2	C2.2	W4.Black		12 AWG

From	To	Color	Gauge
C2.1	C1.Housing		12 AWG
C2.2	RT2		12 AWG

Revisions			
Rev.	Date	Author	Description
A	11/5/2021	Bennet Fisher	Initial Drawing

UNLESS OTHERWISE SPECIFIED DIMENSIONS ARE IN MILLIMETERS [INCHES] TOLERANCES: ±5MM PROPRIETARY AND CONFIDENTIAL THE INFORMATION CONTAINED IN THIS DRAWING IS THE SOLE PROPERTY OF AAMP GLOBAL. ANY REPRODUCTION IN PART OR AS A WHOLE WITHOUT THE WRITTEN PERMISSION OF AAMP GLOBAL IS PROHIBITED.	Designed By	Bennet Fisher	11/5/2021	
	Engineering Approval	----	----	
	Manufacturing Approval	----	----	
	Revision Approval	----	----	
	Quality Assurance	----	----	
Part Number: PWR-HAR4		Revision: ----		
Description: Exterior Light Battery Harness		Sheet: 1 of 1		

PURCHASED COMPONENT KEY FEATURES

DESCRIPTION OF REQUIREMENTS

DIMENSIONAL REQUIREMENTS (AS SHOWN ON DRAWING)

N/A

LOAD/RATING REQUIREMENT

N/A

MATERIAL REQUIREMENT

N/A

PACKAGING REQUIREMENT

N/A

OTHER REQUIREMENTS



THIS DRAWING IS THE PROPERTY OF ADRIAN STEEL COMPANY AND IS NOT TO BE USED IN ANY MANNER DETRIMENTAL TO THE INTERESTS OF ADRIAN STEEL COMPANY

TOLERANCES & INSPECTION

UNLESS OTHERWISE SPECIFIED

ALL BEND ANGLES ARE 90 DEGREES

ALL DIMENSIONS ARE IN INCHES.

REFERENCE DIMENSIONS (X.XXX)
DO NOT REQUIRE INSPECTION

FEATURES	HOLES/SLOTS	ANGLES
0.0 = ± .125	0.0 = ± .062	0° = ± 2°
0.00 = ± .062	0.00 = ± .031	0.0° = ± 1°
0.000 = ± .031	0.000 = ± .015	

Material Thickness: per ASTM Std.
Weld Callouts per AWS

RELEASE & REVISIONS

INITIAL ECN: **25378**

CURRENT ECN: **25378**

ECN DESCRIPTION:

RELEASE FOR PRODUCTION

REVISED BY:

PURCHASED COMPONENT

REFERENCED SUPPLIER AND/OR MANUFACTURER

AAMP GLOBAL

REFERENCED SUPPLIER AND/OR MANUFACTURER PART NUMBER

SSW-HAR1 OR 67097

COLOR (ONLY LIST IF COLOR SPECIFIC)

COMODITY ITEM (Y/N) (YES = ALL DIMENSIONS AND NOTES ARE REFERENCE)
(NOTE: DIMENSIONS AND FEATURES MAY VARY FOR A COMODITY ITEM.)

NO

PRINTED DOCUMENT IS UNCONTROLLED

Sheet 1 of 1

PART / PRODUCT IDENTIFICATION



ADRIAN STEEL®

ADRIAN STEEL COMPANY
906 JAMES STREET, ADRIAN, MI 49221

REVISION LEVEL

A

MAT'L USED: **PURCHASED**

DESIGNED BY: **E.BURKE**

DESCRIPTION: **SWITCH HARNESS 1 EXTERIOR LIGHTING**

WEIGHT (Lbs.): **0.2**

SEGMENT CODE: **ELE**

PART NUMBER: **67097**

Coverings	
Id	Assembly
[12]	

Notes	
①	Lock Tape Loom with Tesa 51608
②	75mm between end of loom and Quick Connects

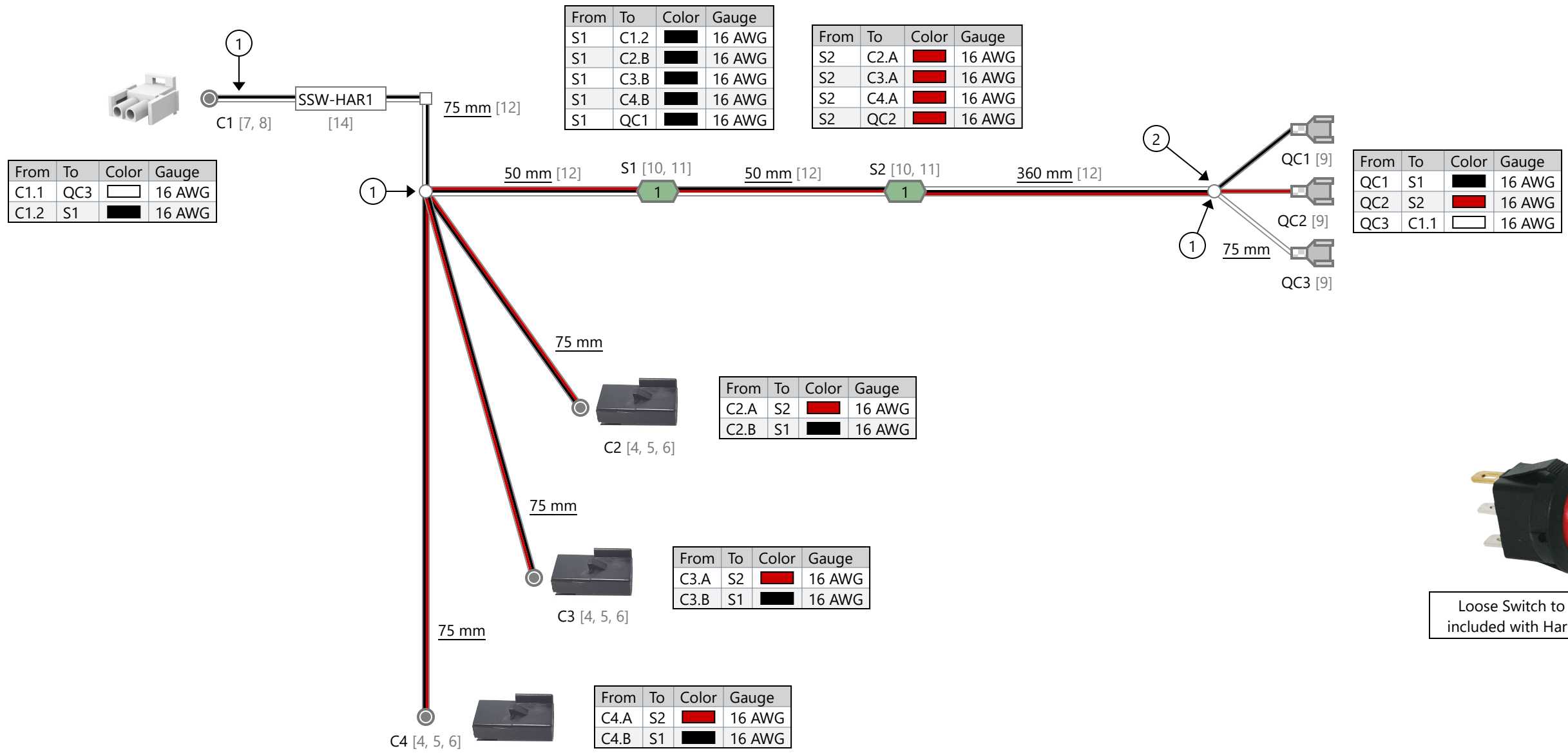

Revisions			
Rev.	Date	Author	Description
A	11/5/2021	Bennet Fisher	Initial Drawing

UNLESS OTHERWISE SPECIFIED DIMENSIONS ARE IN MILLIMETERS (INCHES) TOLERANCES: ±5MM PROPRIETARY AND CONFIDENTIAL THE INFORMATION CONTAINED IN THIS DRAWING IS THE SOLE PROPERTY OF AAMP GLOBAL. ANY REPRODUCTION IN PART OR AS A WHOLE WITHOUT THE WRITTEN PERMISSION OF AAMP GLOBAL IS PROHIBITED.	Designed By	Bennet Fisher	11/5/2021	 — ADVANCING VEHICLE TECHNOLOGY — Part Number: SSW-HAR1 Revision: ---- Description: Strobe Switch Harness - 3 Outputs Sheet: 1 of 1
	Engineering Approval	----	----	
	Manufacturing Approval	----	----	
	Revision Approval	----	----	
	Quality Assurance	----	----	

PURCHASED COMPONENT KEY FEATURES

DESCRIPTION OF REQUIREMENTS

DIMENSIONAL REQUIREMENTS (AS SHOWN ON DRAWING)

N/A

LOAD/RATING REQUIREMENT

N/A

MATERIAL REQUIREMENT

N/A

PACKAGING REQUIREMENT

N/A

OTHER REQUIREMENTS



THIS DRAWING IS THE PROPERTY OF ADRIAN STEEL COMPANY AND IS NOT TO BE USED IN ANY MANNER DETRIMENTAL TO THE INTERESTS OF ADRIAN STEEL COMPANY

TOLERANCES & INSPECTION

UNLESS OTHERWISE SPECIFIED

ALL BEND ANGLES ARE 90 DEGREES

ALL DIMENSIONS ARE IN INCHES.

REFERENCE DIMENSIONS (X.XXX)
DO NOT REQUIRE INSPECTION

FEATURES	HOLES/SLOTS	ANGLES
0.0 = ± .125	0.0 = ± .062	0° = ± 2°
0.00 = ± .062	0.00 = ± .031	0.0° = ± 1°
0.000 = ± .031	0.000 = ± .015	

Material Thickness: per ASTM Std.
Weld Callouts per AWS

RELEASE & REVISIONS

INITIAL ECN: **25378**

CURRENT ECN: **25378**

ECN DESCRIPTION:

RELEASE FOR PRODUCTION

REVISED BY:

PURCHASED COMPONENT

REFERENCED SUPPLIER AND/OR MANUFACTURER

AAMP GLOBAL

REFERENCED SUPPLIER AND/OR MANUFACTURER PART NUMBER

BLB-HAR3 OR 67113

COLOR (ONLY LIST IF COLOR SPECIFIC)

COMODITY ITEM (Y/N) (YES = ALL DIMENSIONS AND NOTES ARE REFERENCE)
(NOTE: DIMENSIONS AND FEATURES MAY VARY FOR A COMODITY ITEM.)

NO

PRINTED DOCUMENT IS UNCONTROLLED

Sheet 1 of 1

PART / PRODUCT IDENTIFICATION



ADRIAN STEEL®

ADRIAN STEEL COMPANY
906 JAMES STREET, ADRIAN, MI 49221

REVISION LEVEL

A

MAT'L USED: **PURCHASED**

DESIGNED BY: **E.BURKE**

DESCRIPTION: **BEACON/LIGHTBAR HARNESS 3**

WEIGHT (Lbs.): **0.2**

SEGMENT CODE: **EBE**

PART NUMBER: **67113**

Bill of Materials

Id	Type	Manufacturer	Part Number	Quantity
1	Cable		16AWG 2C FT2 TPU Cable	6300 mm
2	Cord Grip		PG11	1

Notes

- ① Heat shrink cable jacket and wire 20mm behind connector (Heat shrink = 38mm long)
- ② Place adhesive lined heat shrink over C2 connector wire cavities and cable jacket (Heat shrink = 38mm long)
- ③ Install Cable Gland/Cord Grip 300mm behind C2
- ④ Plug C3 into C2
- ⑤ C3 Cavities are sealed



From	To	Color	Gauge
C1.A	C2.1	Red	16 AWG
C1.B	C2.2	Black	16 AWG

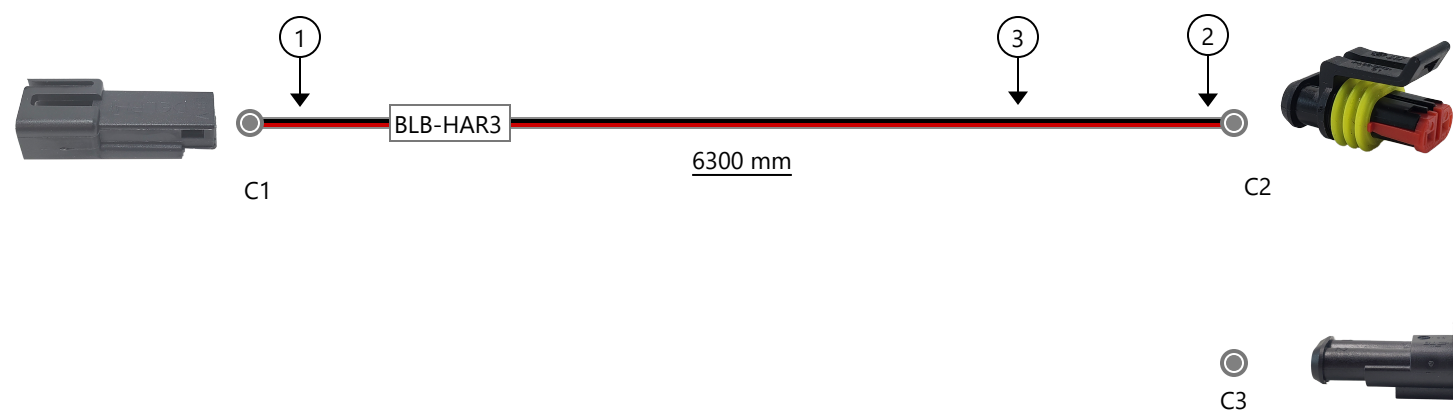

From	To	Color	Gauge
C2.1	C1.A	Red	16 AWG
C2.2	C1.B	Black	16 AWG

Revisions			
Rev.	Date	Author	Description
	11/5/2021	Bennet Fisher	Initial Drawing
	3/21/2022	Bennet Fisher	Added 300mm to harness; changed female connector
A	4/26/2022	Bennet Fisher	Added adhesive lined heat shrink to C2

UNLESS OTHERWISE SPECIFIED DIMENSIONS ARE IN MILLIMETERS [INCHES] TOLERANCES: ±5MM PROPRIETARY AND CONFIDENTIAL THE INFORMATION CONTAINED IN THIS DRAWING IS THE SOLE PROPERTY OF AAMP GLOBAL. ANY REPRODUCTION IN PART OR AS A WHOLE WITHOUT THE WRITTEN PERMISSION OF AAMP GLOBAL IS PROHIBITED.		Name	Date	
	Designed By	Bennet Fisher	04/26/2022	
	Engineering Approval			
	Manufacturing Approval			
	Revision Approval			
Quality Assurance				
			Part Number: BLB-HAR3_	Revision: A
			Description: Beacon/Light Bar Harness - 6.3 Meters	Sheet: 1

PURCHASED COMPONENT KEY FEATURES

DESCRIPTION OF REQUIREMENTS

DIMENSIONAL REQUIREMENTS (AS SHOWN ON DRAWING)

N/A

LOAD/RATING REQUIREMENT

N/A

MATERIAL REQUIREMENT

N/A

PACKAGING REQUIREMENT

N/A

OTHER REQUIREMENTS

**ECCO BEACON LIGHT: 7965A
WITH EXTERIOR PLUG AND PLAY CONNECTOR
AMBER LENS, WHITE LEDS**



THIS DRAWING IS THE PROPERTY OF ADRIAN STEEL COMPANY AND IS NOT TO BE USED IN ANY MANNER
DETRIMENTAL TO THE INTERESTS OF ADRIAN STEEL COMPANY

TOLERANCES & INSPECTION

UNLESS OTHERWISE SPECIFIED

ALL BEND ANGLES ARE 90 DEGREES

ALL DIMENSIONS ARE IN INCHES.

REFERENCE DIMENSIONS (X.XXX)
DO NOT REQUIRE INSPECTION

FEATURES	HOLES/SLOTS	ANGLES
0.0 = ± .125	0.0 = ± .062	0° = ± 2°
0.00 = ± .062	0.00 = ± .031	0.0° = ± 1°
0.000 = ± .031	0.000 = ± .015	

Material Thickness: per ASTM Std.
Weld Callouts per AWS

RELEASE & REVISIONS

INITIAL ECN: **25921**

CURRENT ECN: **25921**

ECN DESCRIPTION:

RELEASE TO PRODUCTION

REVISED BY: **N/A**

PURCHASED COMPONENT

REFERENCED SUPPLIER AND/OR MANUFACTURER

ECCO

REFERENCED SUPPLIER AND/OR MANUFACTURER PART NUMBER

7965A-ADR

COLOR (ONLY LIST IF COLOR SPECIFIC)

AMBER LENS/WHITE LEDS

COMODITY ITEM (Y/N) (YES = ALL DIMENSIONS AND NOTES ARE REFERENCE)
(NOTE: DIMENSIONS AND FEATURES MAY VARY FOR A COMODITY ITEM.)

NO

PRINTED DOCUMENT IS UNCONTROLLED

Sheet 1 of 1

PART / PRODUCT IDENTIFICATION



ADRIAN STEEL®

ADRIAN STEEL COMPANY
906 JAMES STREET, ADRIAN, MI 49221

REVISION LEVEL

A

MAT'L USED: **PURCHASED**

DESIGNED BY: **EMB**

DESCRIPTION: **ECCO LED BCN 7965 W/CONN**

WEIGHT (Lbs.): **1.5**

SEGMENT CODE: **EBE**

PART NUMBER: **67689**

PURCHASED COMPONENT KEY FEATURES

DESCRIPTION OF REQUIREMENTS

DIMENSIONAL REQUIREMENTS (AS SHOWN ON DRAWING)

N/A

LOAD/RATING REQUIREMENT

N/A

MATERIAL REQUIREMENT

N/A

PACKAGING REQUIREMENT

N/A

OTHER REQUIREMENTS

**RUBBER GROMMET:
MCMASTER-CARR 9600K33**

**INNER DIAMETER: 3/8"
PANEL HOLE DIAMETER: 7/16"
PANEL THICKNESS: 3/32"**

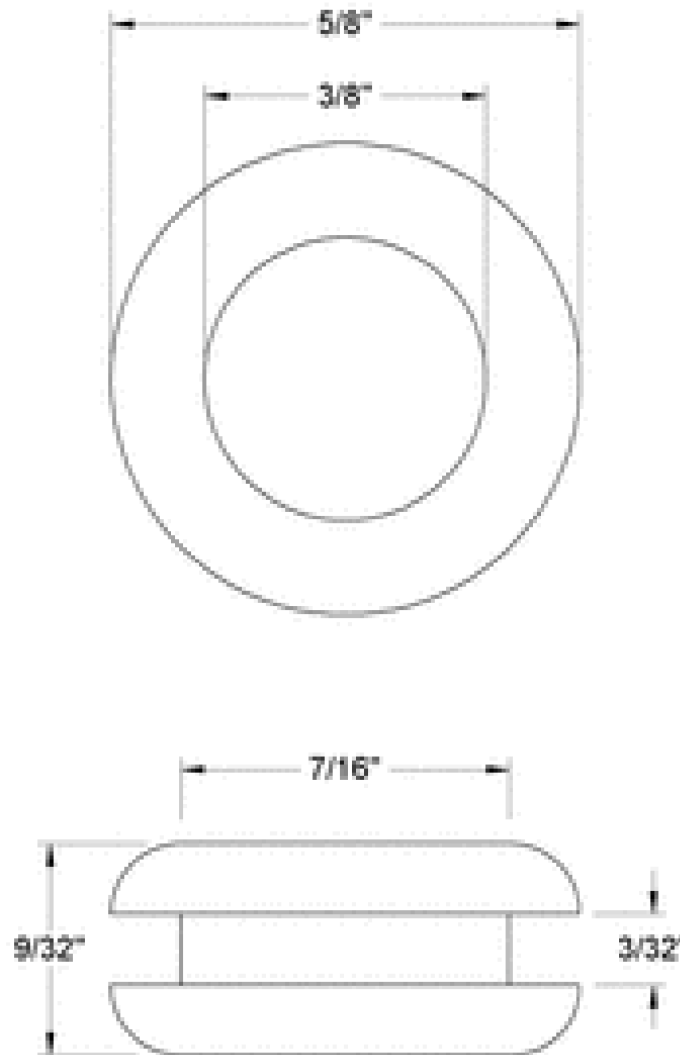

THIS DRAWING IS THE PROPERTY OF ADRIAN STEEL COMPANY AND IS NOT TO BE USED IN ANY MANNER DETRIMENTAL TO THE INTERESTS OF ADRIAN STEEL COMPANY

TOLERANCES & INSPECTION

UNLESS OTHERWISE SPECIFIED

ALL BEND ANGLES ARE 90 DEGREES

ALL DIMENSIONS ARE IN INCHES.

REFERENCE DIMENSIONS (X.XXX)
DO NOT REQUIRE INSPECTION

FEATURES	HOLES/SLOTS	ANGLES
0.0 = ± .125	0.0 = ± .062	0° = ± 2°
0.00 = ± .062	0.00 = ± .031	0.0° = ± 1°
0.000 = ± .031	0.000 = ± .015	

Material Thickness: per ASTM Std.
Weld Callouts per AWS

RELEASE & REVISIONS

INITIAL ECN: **26411**

CURRENT ECN: **26411**

ECN DESCRIPTION:

RELEASE TO PRODUCTION

REVISED BY: **N/A**

PURCHASED COMPONENT

REFERENCED SUPPLIER AND/OR MANUFACTURER

MCMASTR-CARR

REFERENCED SUPPLIER AND/OR MANUFACTURER PART NUMBER

9600K33

COLOR (ONLY LIST IF COLOR SPECIFIC)

BLACK/RUBBER

COMODITY ITEM (Y/N) (YES = ALL DIMENSIONS AND NOTES ARE REFERENCE)
(NOTE: DIMENSIONS AND FEATURES MAY VARY FOR A COMODITY ITEM.)

NO

PRINTED DOCUMENT IS UNCONTROLLED

Sheet 1 of 1

PART / PRODUCT IDENTIFICATION



ADRIAN STEEL®

ADRIAN STEEL COMPANY
906 JAMES STREET, ADRIAN, MI 49221

REVISION LEVEL

A

MAT'L USED: **PURCHASED**

DESIGNED BY: **EMB**

DESCRIPTION: **GROMMET, 3/8"ID 7/16"OD**

WEIGHT (Lbs.): **0.01**

SEGMENT CODE: **EBE**

PART NUMBER: **70805**