

Part Number

68953

36" LED Light Strip (65347)

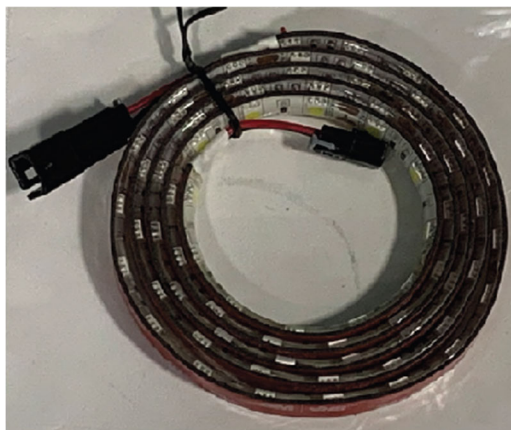

**Roof Bow Harness #2-4
(63482, 63483, 63484)**



Light Kit Installed

PRODUCT FEATURES

- This light kit is compatible for the Ford Transit low roof.
- Included in this kit is three (3) 36" LED light strips (65347), roof bow harness #2-4 (63482, 63483, 63484), power harness (65793), two (2) switches, and various fasteners.
- There are no OEM options that this kit is not compatible with and there are no OEM options that are required for this kit.

Model Year Validated:

2023

Introduction / Comments:

Install Instructions For Interior Plug & Play Lights For Transit

Note:

Read all instructions prior to installation. Review the Adrian Steel **GENERAL PRECAUTIONS PAGES (56638)** before attempting installation. Only personnel familiar with using electrical best practices should perform this install. Reference **ELECTRICAL BEST PRACTICES MANUAL (54479)** before attempting installation.



**Installation Instructions For Interior Plug And
Play Lights For Transit**

****Please read statement below before moving forward****

These plug and play kits are completely modular and can be configured in many different ways. Placement of lights will be determined by sales order drawings/customer ask. Therefore, these instructions are for the most standard configurations, and for reference only. The only harness that is specific to the transit vehicle are the power harnesses 65793 and 65794 (depending on roof bow height). Routing will be very standard across all kits, but placement of lights and switches are subject to be different from these instructions if called out on the order drawing differently.

Overall Harness Diagram

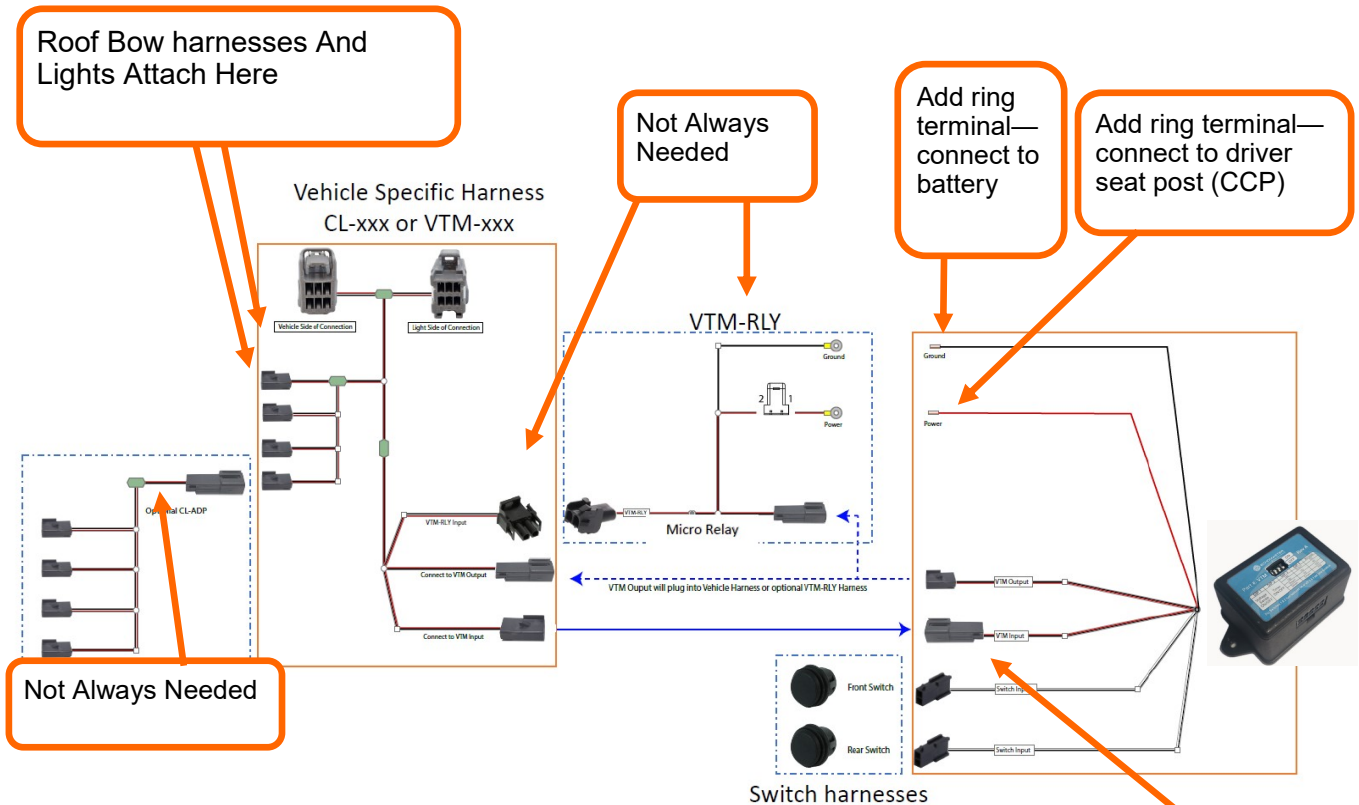

Tools required:

Crimpers

#10 and 1/4" wrench/
drive socket

Power drill, 3/8" step drill
bit, Philips head bit (if in-
stalling dome lights)



For all vehicles that are NOT RAM. This connector will be black. RAM vehicles, this will be white. See page 4 for more details.

Specific Harness Diagram

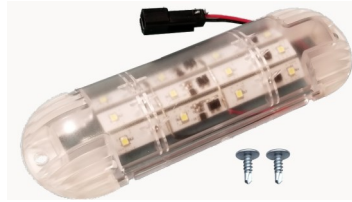

Roof Bow Harnesses and Lights Connect Here

Vehicle Specific Harness
CL-xxx or VTM-xxx

Insert into OEM Light Connector:
See Below

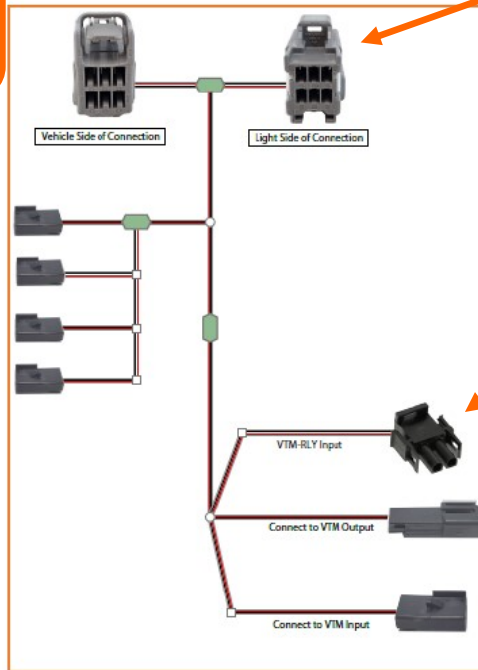

Not Always Needed

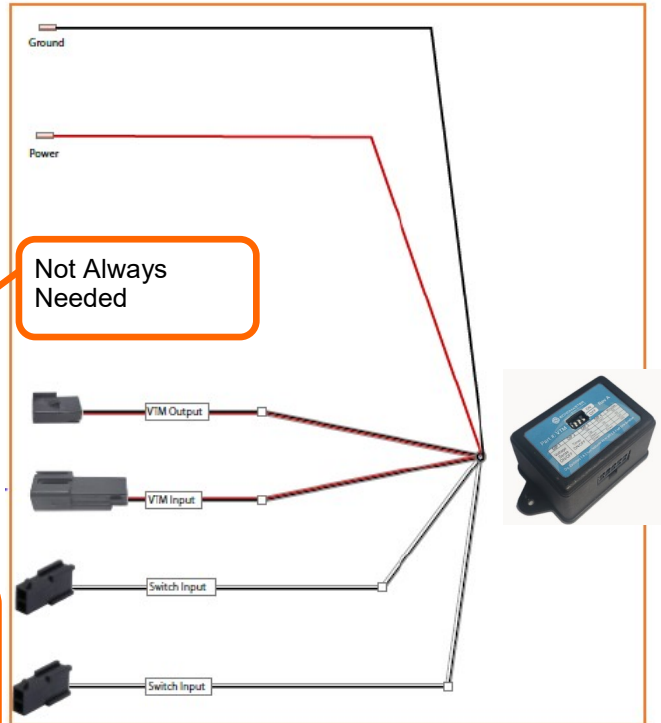

Switch Harness in between

OEM Light Connector for Mid/High Roofs - Located in Driver's Side Cargo Harness

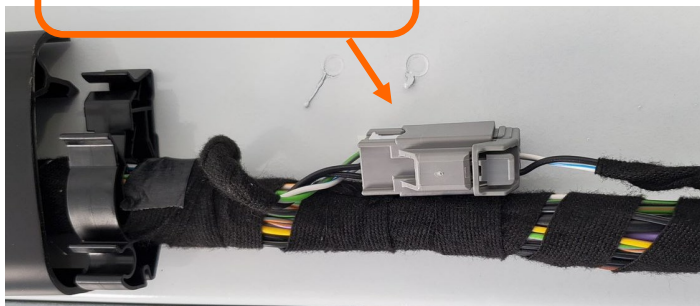

OEM Light Connector for Low Roofs - Located in Driver's Side Harness on First Roof Bow



Voltage Timer Module (VTM) Harness Reference

For all vehicles except RAM, the black input connector will be used to plug into the vehicle specific harness. The white connector will NOT be used.

For all RAM vehicles, the white connector will be used to plug into the vehicle specific harness. The black connector will NOT be used.

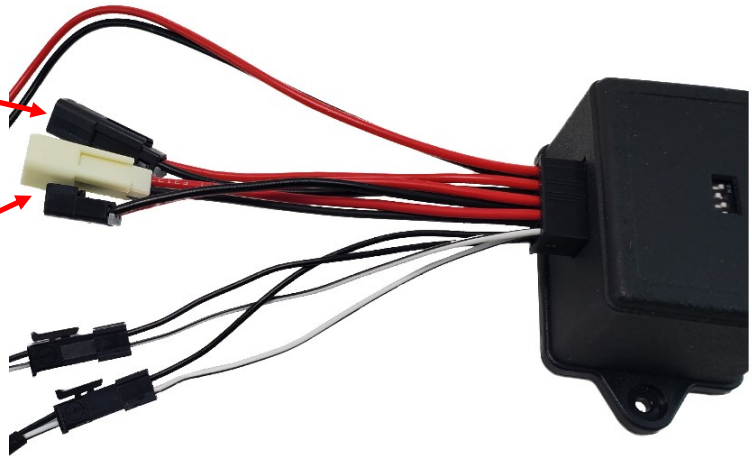

Harnesses Needed

	Part Number	Description
1	65786	Voltage Timer Module (VTM)
2	63480 Or/And 64222, 65346, 65347, 65348	Dome Light Or/And Strip Lights
3	63481 Or/And 63842, 63483, 63484	Roof Bow Harnesses 1 through 4
4	65793 or 65794	Power Harness: Depending on roof height
5	65787 Or/And 65788, 65789, 65790	Switch Harness 1 through 4 for VTM



Harness pictures are for reference only.

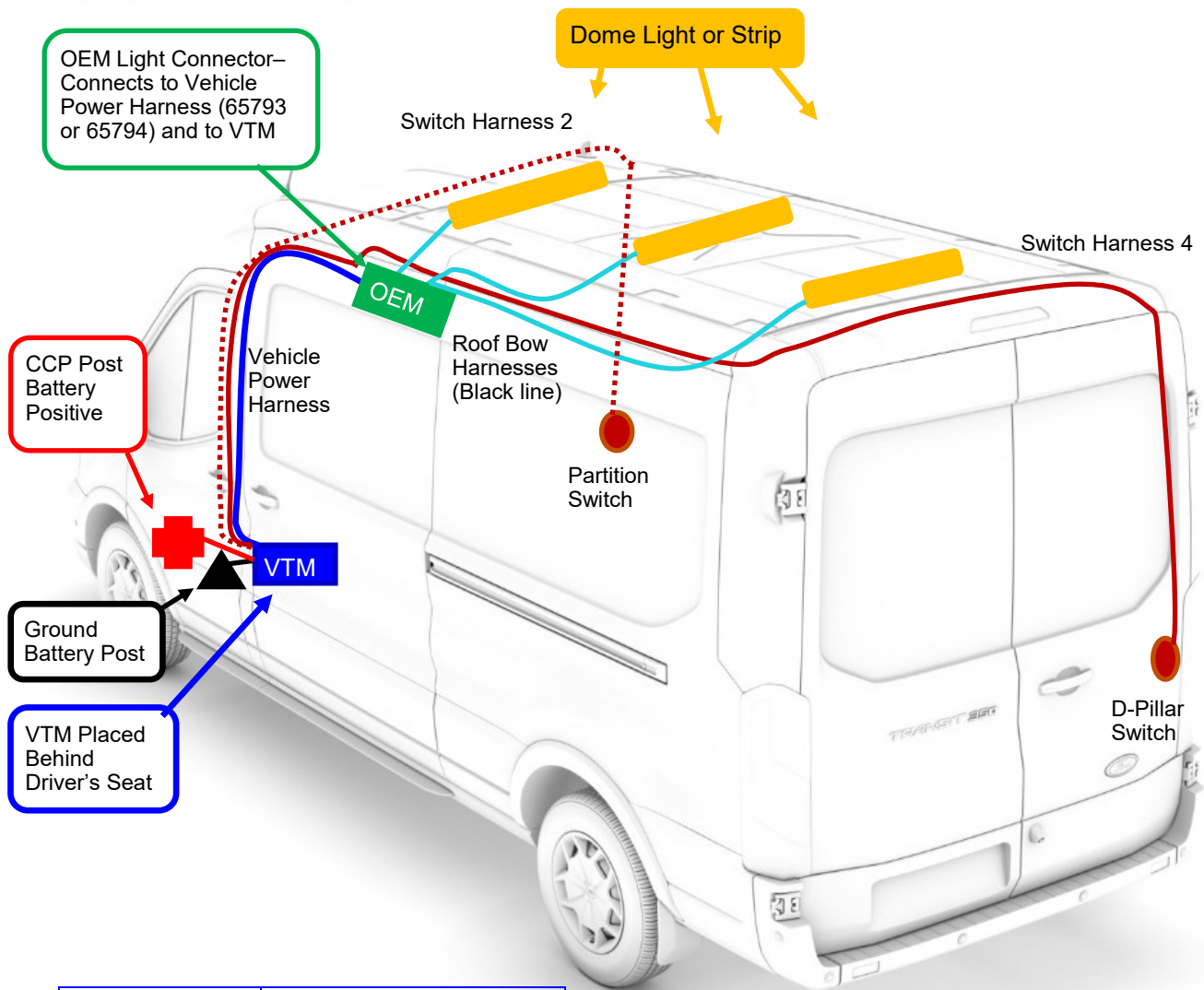

Color	Key - Items
Blue	VTM/Harness
Green	Vehicle Specific Power Harness
Black	Ground Location
Red	12V location
Redish/Brown	Switch Harnesses
Yellow	Dome or Strip Lights
Teal	Roof Bow Harnesses

The purpose of plug and play lighting is to be completely modular. Due to this feature, refer to the order drawing for all exact lighting placements. These installation instructions are for most cases and for reference.

Vehicle	Roof Bow 1	Roof Bow 2	Roof Bow 3	Roof Bow 4
Transit - Low Roof 130" WB	P-HARRB1	P-HARRB2	P-HARRB3	N/A
Transit - Low Roof 148" WB	P-HARRB1	P-HARRB2	P-HARRB3	P-HARRB4

Roof bow placements with harness reference

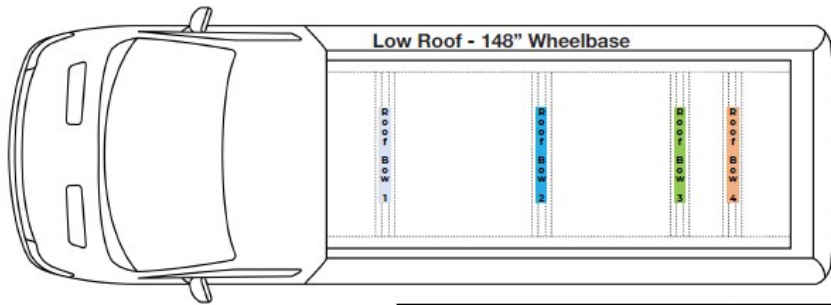
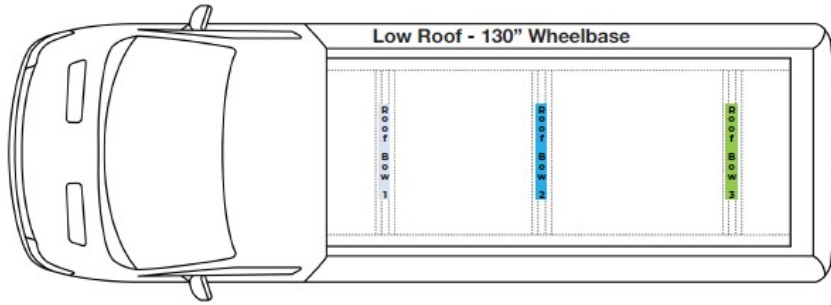

Vehicle	Roof Bow 1	Roof Bow 2	Roof Bow 3	Roof Bow 4
Transit - Med Roof 130" WB	P-HARRB1	P-HARRB2	P-HARRB3	N/A
Transit - Med/High Roof 148" WB	P-HARRB2	P-HARRB2	P-HARRB3	P-HARRB4
Transit - High Roof (Jumbo)	P-HARRB2	P-HARRB2	P-HARRB3	P-HARRB4

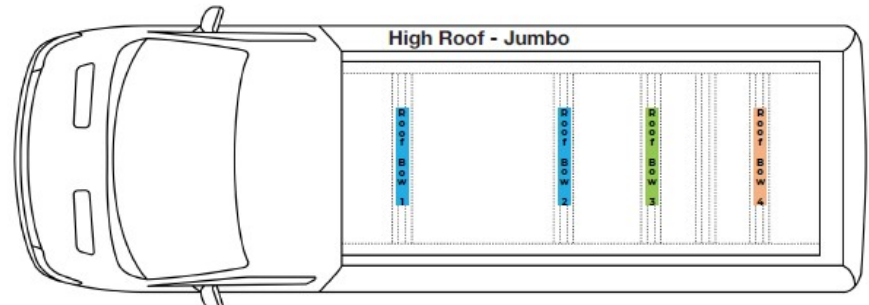
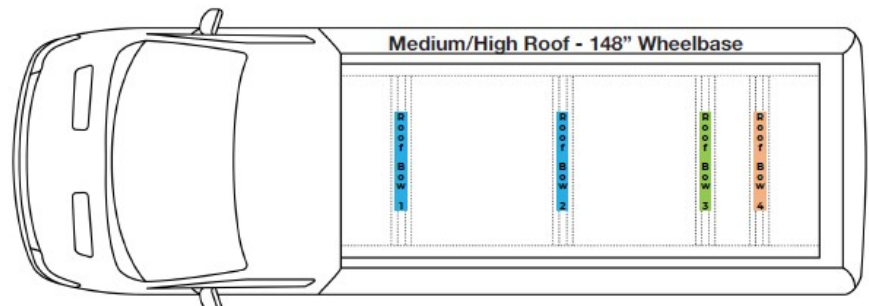
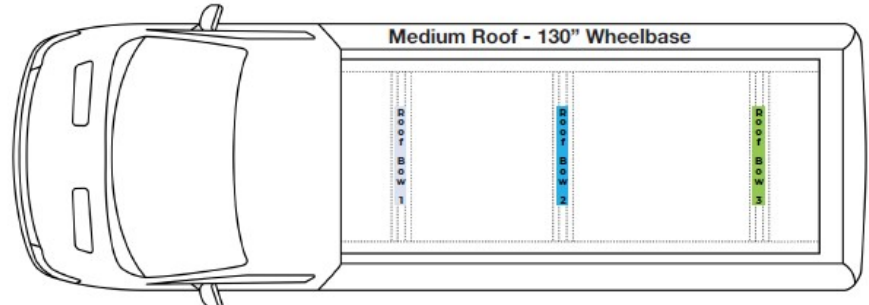

Optional Required Harnesses:

64244: This adapter harness allows for extra extensions to be added (if needed).



Be sure not to overload the OEM circuit by putting too many lights on the circuit. Consult ASCO Electrical Engineering team for application advice if using more than 4 lights.

Add Relay Harness 65791 for extra amperage. (Not always needed)

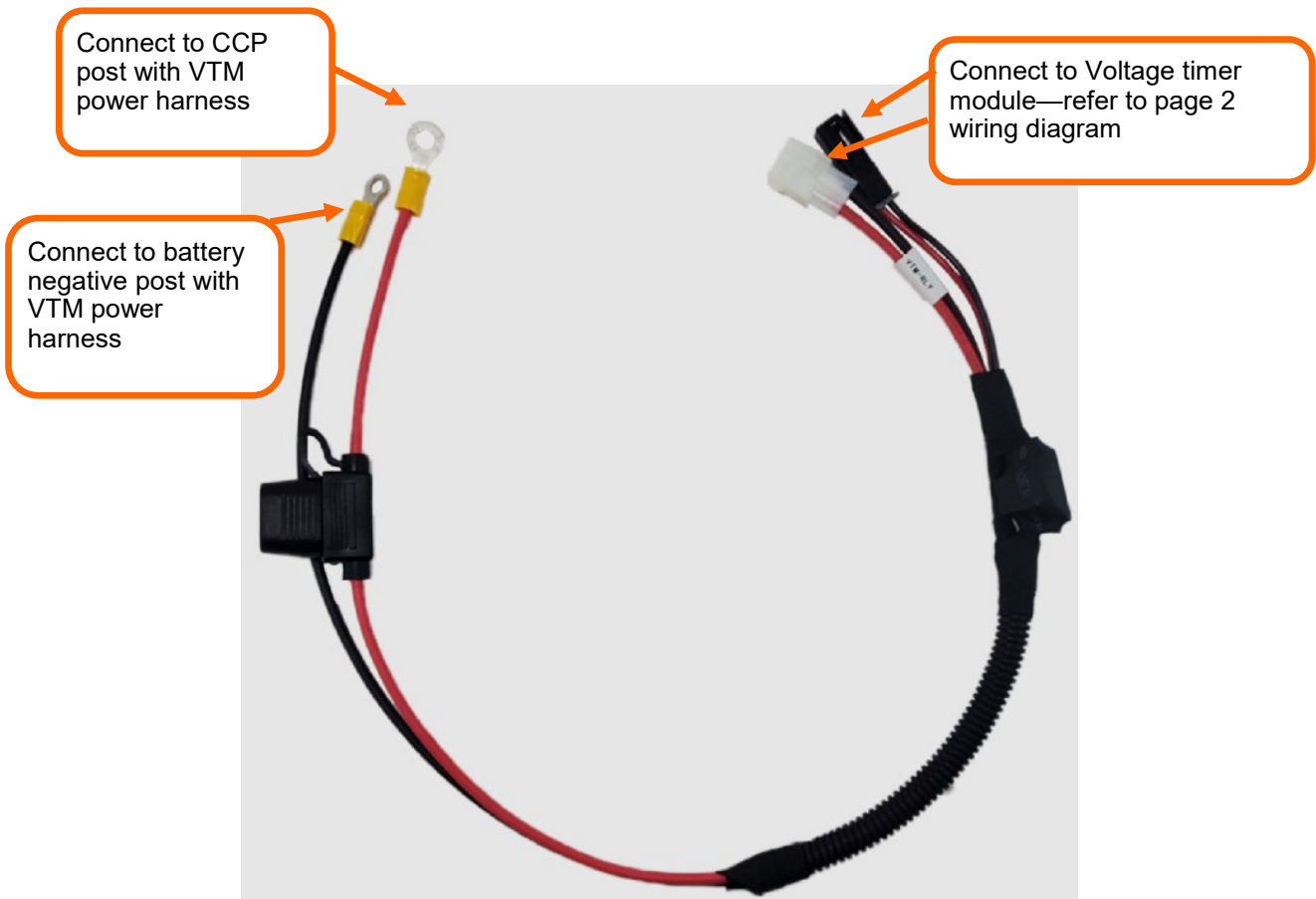
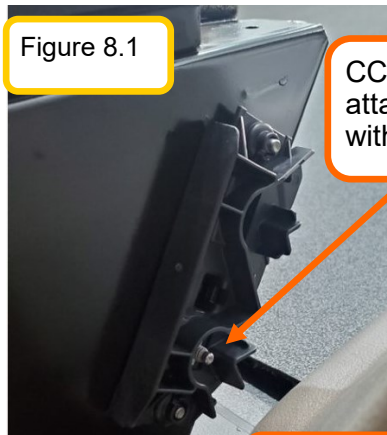
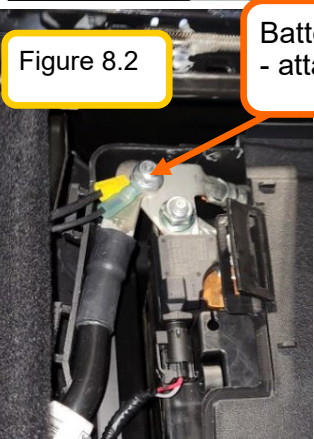

Figure 8.1



CCP positive post - attach ring terminal with FAS0159 nut

Figure 8.2



Battery Negative post - attach ring terminal



Figure 8.3

Figure 8.4



VTM harness routing and zip tied

Step 1: Locate the power harness #65793

Attach the 5/16" ring terminal to the red wire.
Attach the #10 ring terminal to the black wire.

Remove the fuse from the inline fuse holder until the end of the install

Plug the harness connector into the voltage timer module port

Step 2: Attach the positive (red) wire to the CCP on the driver's seat post. Secure with the supplied nut (FAS0159). See Figure 8.1.

Attach the ground ring terminal (black) to the battery negative post. See Figure 8.2.

Route the wires the back of the driver's seat. Secure wires with zip tie

Step 3: *Please be sure to set all the dip switches on the VTM UP*****

Refer to the bottom picture for dip switch settings. If the customer would like a different amount time other than 90 minutes, use the dip switches to set the time

Apply the VHB tape the back of the VTM (voltage timer module). See figure 8.3.

Stick the VTM to the back of the seat base and secure with a zip tie. See figure 8.4.

Plug the switch harnesses (65789 & 65790) into the VTM harness. See pages 2 & 3 for reference.

VTM Dip Switch Settings

DIP SWITCH 1 UP/DOWN	DIP SWITCH 2 UP/DOWN	DIP SWITCH 3	DIP SWITCH 4	Timer Duration (Minutes)
Voltage Sense ON/OFF	Timer ON/OFF	UP	DOWN	60
		UP	UP	90
		DOWN	UP	120
		DOWN	DOWN	150



Step 4:
Plug the vehicle specific power harness into the OEM connector:

Medium/High roof vehicles:
The connector is located along the driver's side OEM wire harness. See figure 9.1.



Low roof vehicles: The connector is located on the first roof bow. See figure 9.2.

Route the power harness down the partition to the VTM module, and plug it in. Be sure to use the black colored VTM input connector referenced on page 4. The white connector will NOT be used for this install.



Step 5:
Connect the roof bow harnesses (63481 Or/And 63842, 63483, 63484 all that are applicable) to their desired light locations.

Use zip ties/fir trees to secure all wiring. See figure 9.3.





Figure 10.1

Step 6:

Before mounting any lights, prep the surface where the light will be placed with the supplied alcohol pad. Let dry for a few minutes, then mount the light.

Be sure the surface is clean before applying the VHB tape. Read the supplied instructions in the lighting boxes.

Mount the strip/dome lights to their desired locations: Refer to the order drawing.



Figure 10.2

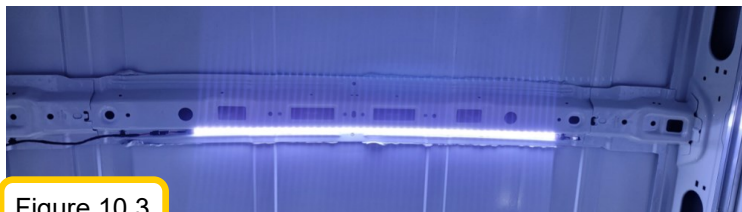

Figure 10.3

For dome lights, use the VHB tape already on the back of the light, and also secure with the supplied tek screws.

Dome lights are to be placed as close to the center of the roof bow as possible, while straddling the gaps in the roof bow. Figure 10.1.

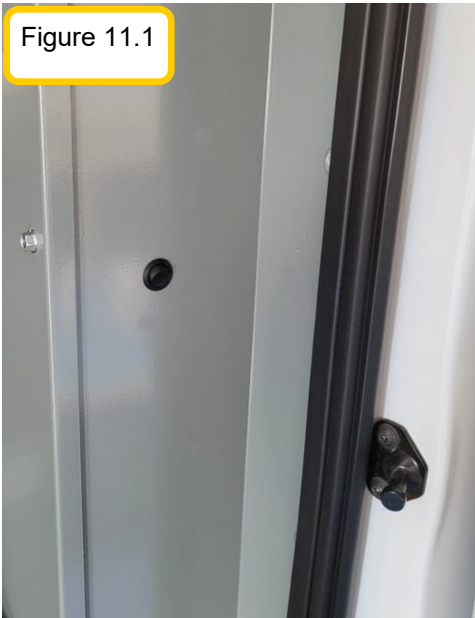

Figure 10.4

For the strip lights, use the VHB tape supplied on the back of the lights, and use the little square sticky backs with zip ties that are supplied in the box.

Strip lights are to be placed on the front side of the roof bow, between the channel/groove. You will see that these lights fit almost perfectly in the channel. Refer to figures 10.2, 10.3, and 10.4 for placements.

Figure 11.1



Partition Switch

Locations:

Switch hole in steel partition (figure 11.1) or drill out switch hole in composite partition (figure 11.2).

This location will require harness #65788

Rear Switch Location:

Passenger side rear D-pillar

See figure 11.3 below for reference.

This location will require harness #65790

Figure 11.2

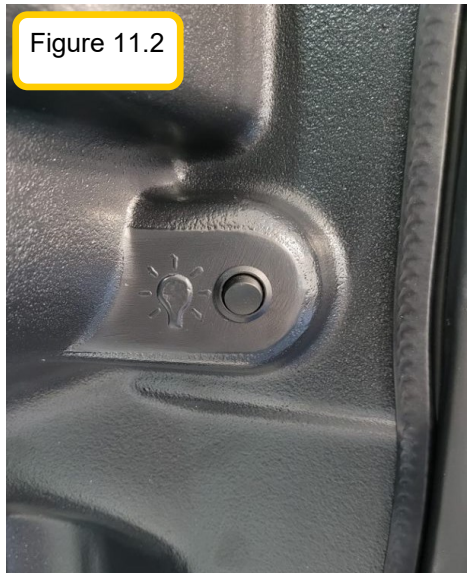

Step 7:

Route the 65788 harness from the VTM harness location (above the drivers seat in the headliner - see routing diagram for reference) to the partition switch location.

Do the same with harness 65790 to the D-pillar switch location.

Use Zip ties to secure wiring.

Figure 11.3

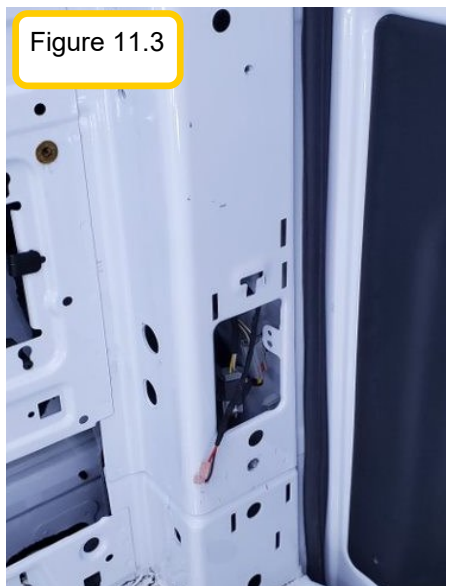

Drill needed holes for the switches in rear D pillar panel, and composite partition (if applicable).

Insert the switches into the holes with the "1" in the 12:00 position, connect the harness (the connection orientation does not matter).

Final install reference pictures



Insert the fuse into the inline-fuse holder on the power harness. The install is now complete. Secure all wiring with zip ties. Re-attach all trim. Double check the functionality of the lights and switches.

PART NUMBER

13905-0

ITEM DESCRIPTION: WIRE TIE, NYLON 40Lb, 8.5" BLACK



MANUFACTURER: WAYTEK, INC. or equivalent
MANUFACTURERS PART NUMBER: 21093M or 21093C

SPECIFICATIONS: STANDARD CABLE TIE
 BLACK, NYLON
 8-1/2" LONG
 TENSILE STRENGTH: 40.0 LBS
 21093M = 1,000 quantity
 21093C = 100 quantity

SPECIAL NOTES: PART NUMBER IS BLACK.

SUPPLIED BY: THIS ITEM IS ADRIAN AVAILABLE!

PURCHASED PRODUCT DATA SHEET (PPDS)

THIS DRAWING/INFORMATION IS THE PROPERTY OF ADRIAN STEEL COMPANY AND IS NOT TO BE USED IN ANY MANNER THAT IS DETRIMENTAL TO THE INTEREST OF ADRIAN STEEL. COPYRIGHTS AND OR PATENTS THAT MAY BE THE PROPERTY OF APPLICABLE OWNERS MAY PROTECT INFORMATION AND/OR DRAWINGS OF SUPPLIED PRODUCTS.



ADRIAN STEEL
VAN AND PICKUP EQUIPMENT

906 JAMES STREET
ADRIAN, MI 49221
517-265-6194
WWW.ADRIANSTEEL.COM



WHEN INSTALLING EQUIPMENT IN OR ON VEHICLES CHECK FOR FUEL TANKS, FUEL LINES, CONTROL LINES AND ELECTRICAL WIRING BEFORE DRILLING! ALWAYS USE DRILL BITS WITH INTEGRAL STOPS WHENEVER POSSIBLE!

DRAWN BY MDG	DATE DRAWN 10/26/2006
ECN NUMBER 18021	ECN DATE 11/13/2015
PART WEIGHT 0.01 LBS.	REV. LEVEL D
PART NUMBER 13905-0	

ITEM DESCRIPTION: RING TERMINAL, 5/16"ID FOR 14-16 GA WIRE



Typical vinyl insulated

MANUFACTURER: WAYTEK or CTW
 MANUFACTURERS PART NUMBER: #31505 or #60-14-16

SPECIFICATIONS: INSTALLER SUPPLIED RING TERMINAL
 14-16 GA WIRE
 5/16" ID
 BLUE VINYL INSULATED

SPECIAL NOTES:

SUPPLIED BY: THIS ITEM IS ADRIAN AVAILABLE!

PURCHASED PRODUCT DATA SHEET (PPDS)

THIS DRAWING/INFORMATION IS THE PROPERTY OF ADRIAN STEEL COMPANY AND IS NOT TO BE USED IN ANY MANNER THAT IS DETRIMENTAL TO THE INTEREST OF ADRIAN STEEL. COPYRIGHTS AND OR PATENTS THAT MAY BE THE PROPERTY OF APPLICABLE OWNERS MAY PROTECT INFORMATION AND/OR DRAWINGS OF SUPPLIED PRODUCTS.



ADRIAN STEEL
 VAN AND PICKUP EQUIPMENT

906 JAMES STREET
 ADRIAN, MI 49221
 517-265-6194
 WWW.ADRIANSTEEL.COM

CAUTION

WHEN INSTALLING EQUIPMENT IN OR ON VEHICLES CHECK FOR FUEL TANKS, FUEL LINES, CONTROL LINES AND ELECTRICAL WIRING BEFORE DRILLING! ALWAYS USE DRILL BITS WITH INTEGRAL STOPS WHENEVER POSSIBLE!

DRAWN BY MDG	DATE DRAWN 10/01/2007
-----------------	--------------------------

ECN NUMBER 13982	ECN DATE 06/27/2011
---------------------	------------------------

PART WEIGHT 0.01 LBS.	REV. LEVEL B
--------------------------	-----------------

PART NUMBER 35120-0

PURCHASED COMPONENT KEY FEATURES

DESCRIPTION OF REQUIREMENTS

DIMENSIONAL REQUIREMENTS (AS SHOWN ON DRAWING)

Base is a 0.975 inch square

LOAD/RATING REQUIREMENT

N/A

MATERIAL REQUIREMENT

N/A

PACKAGING REQUIREMENT

N/A

OTHER REQUIREMENTS

Black adhesive wire tie mounting base.

Cure Time: Bond 15 Min., Max
Adhesion 1 Hr.

Max. Operating 158

Temp. F:

Max. Operating 70

Temp. C:

Min. Installation 65

Temp. F:

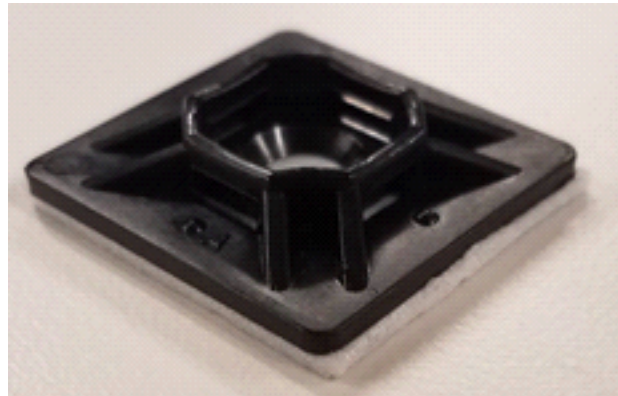

THIS DRAWING IS THE PROPERTY OF ADRIAN STEEL COMPANY AND IS NOT TO BE USED IN ANY MANNER DETRIMENTAL TO THE INTERESTS OF ADRIAN STEEL COMPANY

TOLERANCES & INSPECTION

UNLESS OTHERWISE SPECIFIED

ALL BEND ANGLES ARE 90 DEGREES

ALL DIMENSIONS ARE IN INCHES.

REFERENCE DIMENSIONS (X.XXX)
DO NOT REQUIRE INSPECTION

FEATURES	HOLES/SLOTS	ANGLES
0.0 = ± .125	0.0 = ± .062	0° = ± 2°
0.00 = ± .062	0.00 = ± .031	0.0° = ± 1°
0.000 = ± .031	0.000 = ± .015	

Material Thickness: per ASTM Std.
Weld Callouts per AWS

RELEASE & REVISIONS

INITIAL ECN: 17429

CURRENT ECN: 22185

ECN DESCRIPTION:

Size of the base changed with a change in supplier

REVISED BY: D. LaCroix

PURCHASED COMPONENT

REFERENCED SUPPLIER AND/OR MANUFACTURER

Midstate

REFERENCED SUPPLIER AND/OR MANUFACTURER PART NUMBER

49401

COLOR (ONLY LIST IF COLOR SPECIFIC)

COMODITY ITEM (Y/N) (YES = ALL DIMENSIONS AND NOTES ARE REFERENCE)
(NOTE: DIMENSIONS AND FEATURES MAY VARY FOR A COMODITY ITEM.)

YES

PRINTED DOCUMENT IS UNCONTROLLED

Sheet 1 of 1

PART / PRODUCT IDENTIFICATION



ADRIAN STEEL

ADRIAN STEEL COMPANY
906 JAMES STREET, ADRIAN, MI 49221

REVISION LEVEL

B

MAT'L USED:

DESIGNED BY: **RJB**

DESCRIPTION:

Adhesive wire tie base

WEIGHT (Lbs.):

0.05

SEGMENT CODE:

HDW

PART NUMBER: **49401**

PURCHASED COMPONENT KEY FEATURES

DESCRIPTION OF REQUIREMENTS

DIMENSIONAL REQUIREMENTS (AS SHOWN ON DRAWING)

N/A

LOAD/RATING REQUIREMENT

N/A

MATERIAL REQUIREMENT

N/A

PACKAGING REQUIREMENT

N/A

OTHER REQUIREMENTS

- **Roof Bow #2**
- **(5x) WIRE TIE W/CHRISTMAS TREE**
- **1570mm Length**



P-HARRB2

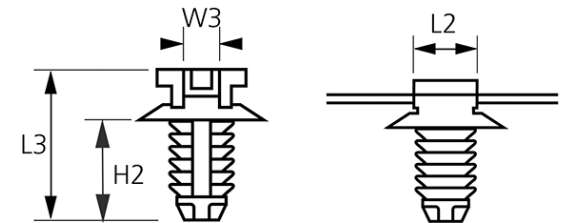

(5x)

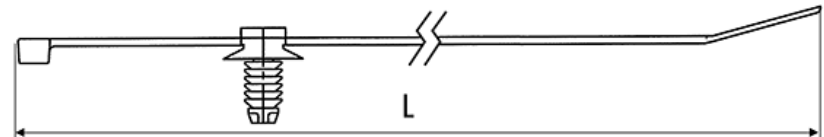

THIS DRAWING IS THE PROPERTY OF ADRIAN STEEL COMPANY AND IS NOT TO BE USED IN ANY MANNER DETRIMENTAL TO THE INTERESTS OF ADRIAN STEEL COMPANY

PRINTED DOCUMENT IS UNCONTROLLED

Sheet 1 of 1

TOLERANCES & INSPECTION

RELEASE & REVISIONS

PURCHASED COMPONENT

PART / PRODUCT IDENTIFICATION

UNLESS OTHERWISE SPECIFIED

ALL BEND ANGLES ARE 90 DEGREES

ALL DIMENSIONS ARE IN INCHES.

REFERENCE DIMENSIONS (X.XXX) DO NOT REQUIRE INSPECTION

FEATURES	HOLES/SLOTS	ANGLES
0.0 = ± .125	0.0 = ± .062	0° = ± 2°
0.00 = ± .062	0.00 = ± .031	0.0° = ± 1°
0.000 = ± .031	0.000 = ± .015	

Material Thickness: per ASTM Std.
Weld Callouts per AWS

INITIAL ECN:	24359
CURRENT ECN:	24359
ECN DESCRIPTION:	QE8539 RELEASE MODULAR DOME LIGHTING
REVISED BY:	MJF

REFERENCED SUPPLIER AND/OR MANUFACTURER
ECHOMASTER FLEET SOLUTIONS

REFERENCED SUPPLIER AND/OR MANUFACTURER PART NUMBER
P-HARRB2

COLOR (ONLY LIST IF COLOR SPECIFIC)

COMODITY ITEM (Y/N) (YES = ALL DIMENSIONS AND NOTES ARE REFERENCE)
(NOTE: DIMENSIONS AND FEATURES MAY VARY FOR A COMODITY ITEM.)
YES

ADRIAN STEEL <small>ADRIAN STEEL COMPANY 906 JAMES STREET, ADRIAN, MI 49221</small>		REVISION LEVEL A
MAT'L USED:	PURCHASED	DESIGNED BY: MJF
DESCRIPTION: ROOF BOW HARNESS #2		
WEIGHT (Lbs.):	.50	PART NUMBER: 63482
SEGMENT CODE:	EAU	

PURCHASED COMPONENT KEY FEATURES

DESCRIPTION OF REQUIREMENTS

DIMENSIONAL REQUIREMENTS (AS SHOWN ON DRAWING)

N/A

LOAD/RATING REQUIREMENT

N/A

MATERIAL REQUIREMENT

N/A

PACKAGING REQUIREMENT

N/A

OTHER REQUIREMENTS

- **Roof Bow #3**
- **(5x) WIRE TIE W/CHRISTMAS TREE**
- **2570mm Length**



P-HARRB3

(5x)

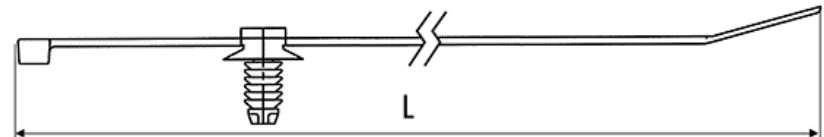
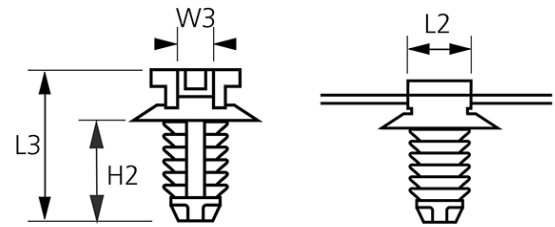
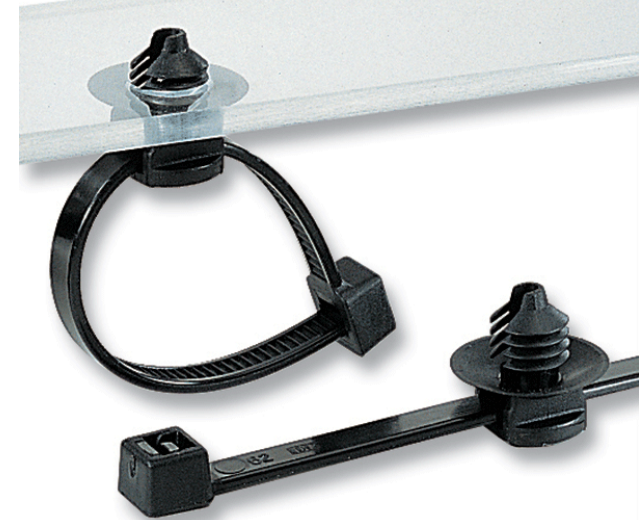

THIS DRAWING IS THE PROPERTY OF ADRIAN STEEL COMPANY AND IS NOT TO BE USED IN ANY MANNER DETRIMENTAL TO THE INTERESTS OF ADRIAN STEEL COMPANY

PRINTED DOCUMENT IS UNCONTROLLED

Sheet 1 of 1

TOLERANCES & INSPECTION

UNLESS OTHERWISE SPECIFIED

ALL BEND ANGLES ARE 90 DEGREES

ALL DIMENSIONS ARE IN INCHES.

REFERENCE DIMENSIONS (X.XXX)

DO NOT REQUIRE INSPECTION

FEATURES	HOLES/SLOTS	ANGLES
0.0 = ± .125	0.0 = ± .062	0° = ± 2°
0.00 = ± .062	0.00 = ± .031	0.0° = ± 1°
0.000 = ± .031	0.000 = ± .015	

Material Thickness: per ASTM Std.
Weld Callouts per AWS

RELEASE & REVISIONS

INITIAL ECN: 24359

CURRENT ECN: 24359

ECN DESCRIPTION:

QE8539 RELEASE MODULAR DOME LIGHTING

REVISED BY: MJF

PURCHASED COMPONENT

REFERENCED SUPPLIER AND/OR MANUFACTURER
ECHOMASTER FLEET SOLUTIONS

REFERENCED SUPPLIER AND/OR MANUFACTURER PART NUMBER

P-HARRB3

COLOR (ONLY LIST IF COLOR SPECIFIC)

COMMODITY ITEM (Y/N) (YES = ALL DIMENSIONS AND NOTES ARE REFERENCE)
(NOTE: DIMENSIONS AND FEATURES MAY VARY FOR A COMMODITY ITEM.)

YES

PART / PRODUCT IDENTIFICATION



ADRIAN STEEL

ADRIAN STEEL COMPANY
906 JAMES STREET, ADRIAN, MI 49221

REVISION LEVEL

A

MAT'L USED: **PURCHASED**

DESIGNED BY: **MJF**

DESCRIPTION: **ROOF BOW HARNESS #3**

WEIGHT (Lbs.):

.50

SEGMENT CODE: **EAU**

PART NUMBER: **63483**

PURCHASED COMPONENT KEY FEATURES

DESCRIPTION OF REQUIREMENTS

DIMENSIONAL REQUIREMENTS (AS SHOWN ON DRAWING)

N/A

LOAD/RATING REQUIREMENT

N/A

MATERIAL REQUIREMENT

N/A

PACKAGING REQUIREMENT

N/A

OTHER REQUIREMENTS

- **Roof Bow #4**
- **(5x) WIRE TIE W/CHRISTMAS TREE**
- **3470mm Length**



P-HARRB4

(5x)

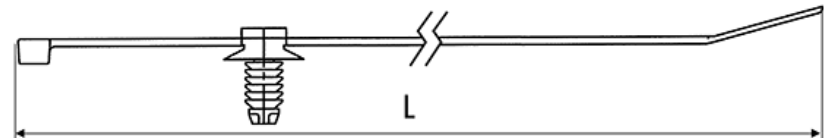
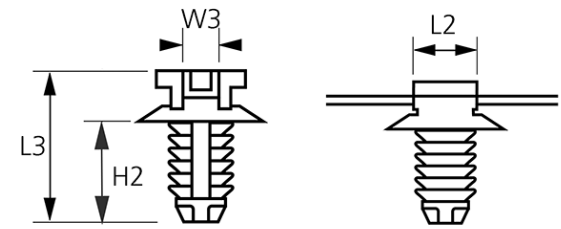

THIS DRAWING IS THE PROPERTY OF ADRIAN STEEL COMPANY AND IS NOT TO BE USED IN ANY MANNER DETRIMENTAL TO THE INTERESTS OF ADRIAN STEEL COMPANY

PRINTED DOCUMENT IS UNCONTROLLED

Sheet 1 of 1

TOLERANCES & INSPECTION

UNLESS OTHERWISE SPECIFIED

ALL BEND ANGLES ARE 90 DEGREES

ALL DIMENSIONS ARE IN INCHES.

REFERENCE DIMENSIONS (X.XXX)

DO NOT REQUIRE INSPECTION

FEATURES	HOLES/SLOTS	ANGLES
0.0 = ± .125	0.0 = ± .062	0° = ± 2°
0.00 = ± .062	0.00 = ± .031	0.0° = ± 1°
0.000 = ± .031	0.000 = ± .015	

Material Thickness: per ASTM Std.
Weld Callouts per AWS

RELEASE & REVISIONS

INITIAL ECN: 24359

CURRENT ECN: 24359

ECN DESCRIPTION:

QE8539 RELEASE MODULAR DOME LIGHTING

REVISED BY: MJF

PURCHASED COMPONENT

REFERENCED SUPPLIER AND/OR MANUFACTURER
ECHOMASTER FLEET SOLUTIONS

REFERENCED SUPPLIER AND/OR MANUFACTURER PART NUMBER

P-HARRB4

COLOR (ONLY LIST IF COLOR SPECIFIC)

COMODITY ITEM (Y/N) (YES = ALL DIMENSIONS AND NOTES ARE REFERENCE)
(NOTE: DIMENSIONS AND FEATURES MAY VARY FOR A COMODITY ITEM.)

YES

PART / PRODUCT IDENTIFICATION



ADRIAN STEEL

ADRIAN STEEL COMPANY
906 JAMES STREET, ADRIAN, MI 49221

REVISION LEVEL

A

MAT'L USED: **PURCHASED**

DESIGNED BY: **MJF**

DESCRIPTION: **ROOF BOW HARNESS #4**

WEIGHT (Lbs.):

.50

SEGMENT CODE: **EAU**

PART NUMBER: **63484**

PURCHASED COMPONENT KEY FEATURES

DESCRIPTION OF REQUIREMENTS

DIMENSIONAL REQUIREMENTS (AS SHOWN ON DRAWING)

N/A

LOAD/RATING REQUIREMENT

N/A

MATERIAL REQUIREMENT

N/A

PACKAGING REQUIREMENT

N/A

OTHER REQUIREMENTS

Note:

Connector / Terminal Configuration:

- MALE 2 PIN ON ONE END
- FEMALE 2 PIN ON THE OPPOSITE END.

BOM:

Item	Qty.	Description
1	1	36" WHITE LED STRIP LIGHT W/ADHESIVE
2	2	4" ZIP TIE
3	2	CABLE TIE MOUNT
4	1	ALCOHOL PAD



THIS DRAWING IS THE PROPERTY OF ADRIAN STEEL COMPANY AND IS NOT TO BE USED IN ANY MANNER DETRIMENTAL TO THE INTERESTS OF ADRIAN STEEL COMPANY

TOLERANCES & INSPECTION

UNLESS OTHERWISE SPECIFIED

ALL BEND ANGLES ARE 90 DEGREES

ALL DIMENSIONS ARE IN INCHES.

REFERENCE DIMENSIONS (X.XXX)
DO NOT REQUIRE INSPECTION

FEATURES	HOLES/SLOTS	ANGLES
0.0 = ± .125	0.0 = ± .062	0° = ± 2°
0.00 = ± .062	0.00 = ± .031	0.0° = ± 1°
0.000 = ± .031	0.000 = ± .015	

Material Thickness: per ASTM Std.
Weld Callouts per AWS

RELEASE & REVISIONS

INITIAL ECN: **24697**

CURRENT ECN: **25778**

ECN DESCRIPTION:

Revise Modular Lights With New 3M Adhesive

REVISED BY: **JLT**

PURCHASED COMPONENT

REFERENCED SUPPLIER AND/OR MANUFACTURER

AAMP

REFERENCED SUPPLIER AND/OR MANUFACTURER PART NUMBER

CL-36BLED rev.B

COLOR (ONLY LIST IF COLOR SPECIFIC)

COMODITY ITEM (Y/N) (YES = ALL DIMENSIONS AND NOTES ARE REFERENCE)
(NOTE: DIMENSIONS AND FEATURES MAY VARY FOR A COMODITY ITEM.)

YES

PRINTED DOCUMENT IS UNCONTROLLED

Sheet 1 of 1

PART / PRODUCT IDENTIFICATION



ADRIAN STEEL®

ADRIAN STEEL COMPANY
906 JAMES STREET, ADRIAN, MI 49221

REVISION LEVEL

B

MAT'L USED:

DESIGNED BY: **J. TYNER**

DESCRIPTION:

MODULE DOME LED STRIP 36"

WEIGHT (Lbs.): **0.3**

SEGMENT CODE: **EAU**

PART NUMBER: **65347**

Notes

- ① 3:1 Adhesive Heat Shrink to be placed over LED Solder Joints
- ② 5925 Adhesive Liner Edges to be exposed next to heat shrink

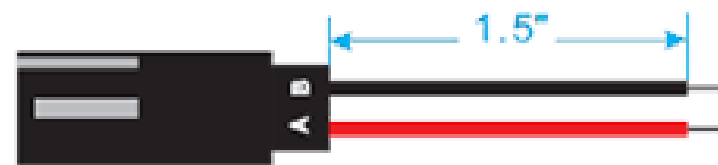
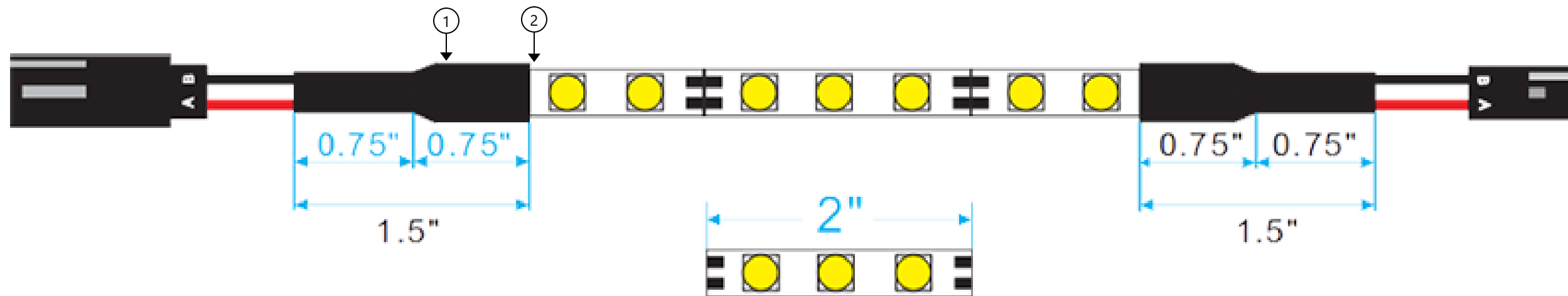

12"=6X
 24"=12X
 36"=18X
 48"=24X

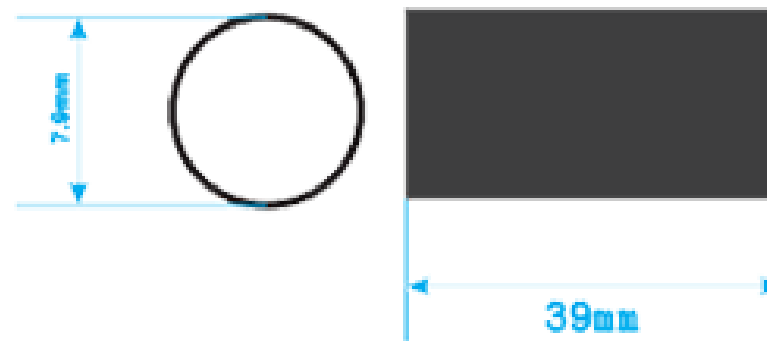

Revisions

Rev.	Date	Author	Description
A	11/1/21	Bennet Fisher	Initial Drawing
B	7/27/2022	Bennet Fisher	Adhesive changed to VHB 5925

UNLESS OTHERWISE SPECIFIED
 DIMENSIONS ARE IN MILLIMETERS [INCHES]
 TOLERANCES: ±5MM

PROPRIETARY AND CONFIDENTIAL

THE INFORMATION CONTAINED IN THIS
 DRAWING IS THE SOLE PROPERTY OF
 AAMP GLOBAL. ANY REPRODUCTION IN
 PART OR AS A WHOLE WITHOUT THE
 WRITTEN PERMISSION OF AAMP GLOBAL
 IS PROHIBITED.

	Name	Date
Designed By	Bennet Fisher	11/1/21
Engineering Approval		
Manufacturing Approval		
Revision Approval		
Quality Assurance		



Part Number: CL-36BLED	Revision: B
Description: 36" LED Strip	Sheet: 1

PURCHASED COMPONENT KEY FEATURES

DESCRIPTION OF REQUIREMENTS

DIMENSIONAL REQUIREMENTS (AS SHOWN ON DRAWING)

N/A

LOAD/RATING REQUIREMENT

N/A

MATERIAL REQUIREMENT

N/A

PACKAGING REQUIREMENT

N/A

OTHER REQUIREMENTS

INCLUDES HARNESS - "P-VTM-HAR"



THIS DRAWING IS THE PROPERTY OF ADRIAN STEEL COMPANY AND IS NOT TO BE USED IN ANY MANNER DETRIMENTAL TO THE INTERESTS OF ADRIAN STEEL COMPANY

TOLERANCES & INSPECTION

UNLESS OTHERWISE SPECIFIED

ALL BEND ANGLES ARE 90 DEGREES

ALL DIMENSIONS ARE IN INCHES.

REFERENCE DIMENSIONS (X.XXX)
DO NOT REQUIRE INSPECTION

FEATURES	HOLES/SLOTS	ANGLES
0.0 = ± .125	0.0 = ± .062	0° = ± 2°
0.00 = ± .062	0.00 = ± .031	0.0° = ± 1°
0.000 = ± .031	0.000 = ± .015	

Material Thickness: per ASTM Std.
Weld Callouts per AWS

RELEASE & REVISIONS

INITIAL ECN: **25377**

CURRENT ECN: **25377**

ECN DESCRIPTION:

RELEASE FOR PRODUCTION

REVISED BY:

PURCHASED COMPONENT

REFERENCED SUPPLIER AND/OR MANUFACTURER

AAMP GLOBAL

REFERENCED SUPPLIER AND/OR MANUFACTURER PART NUMBER

VTM OR 65786

COLOR (ONLY LIST IF COLOR SPECIFIC)

COMODITY ITEM (Y/N) (YES = ALL DIMENSIONS AND NOTES ARE REFERENCE)
(NOTE: DIMENSIONS AND FEATURES MAY VARY FOR A COMODITY ITEM.)

NO

PRINTED DOCUMENT IS UNCONTROLLED

Sheet 1 of 1

PART / PRODUCT IDENTIFICATION



ADRIAN STEEL®

ADRIAN STEEL COMPANY
906 JAMES STREET, ADRIAN, MI 49221

REVISION LEVEL

A

MAT'L USED: **PURCHASED**

DESIGNED BY: **E.BURKE**

DESCRIPTION: **VOLTAGE TIMER MODULE**

WEIGHT (Lbs.): **0.2**

SEGMENT CODE: **ELE**

PART NUMBER: **65786**

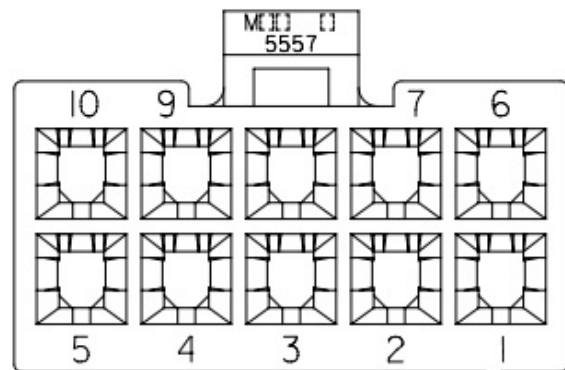

Rear View of Connector - Wire Side of Connector

From	To	Color	Gauge
C1.1	Fuse_Holder.1	Red	16 AWG
C1.2	Input1.A	Red	16 AWG
C1.3	Output.A	Red	16 AWG
C1.4	Input2.A	Red	16 AWG
C1.5	SW1_Input.1	White/Black	20 AWG
C1.5	SW2_Input.1	White/Black	20 AWG
C1.6	GND	Black	16 AWG
C1.7	Input1.B	Black	16 AWG
C1.8	Output.B	Black	16 AWG
C1.9	Input2.B	Black	16 AWG
C1.10	SW1_Input.2	Black	20 AWG
C1.10	SW2_Input.2	Black	20 AWG

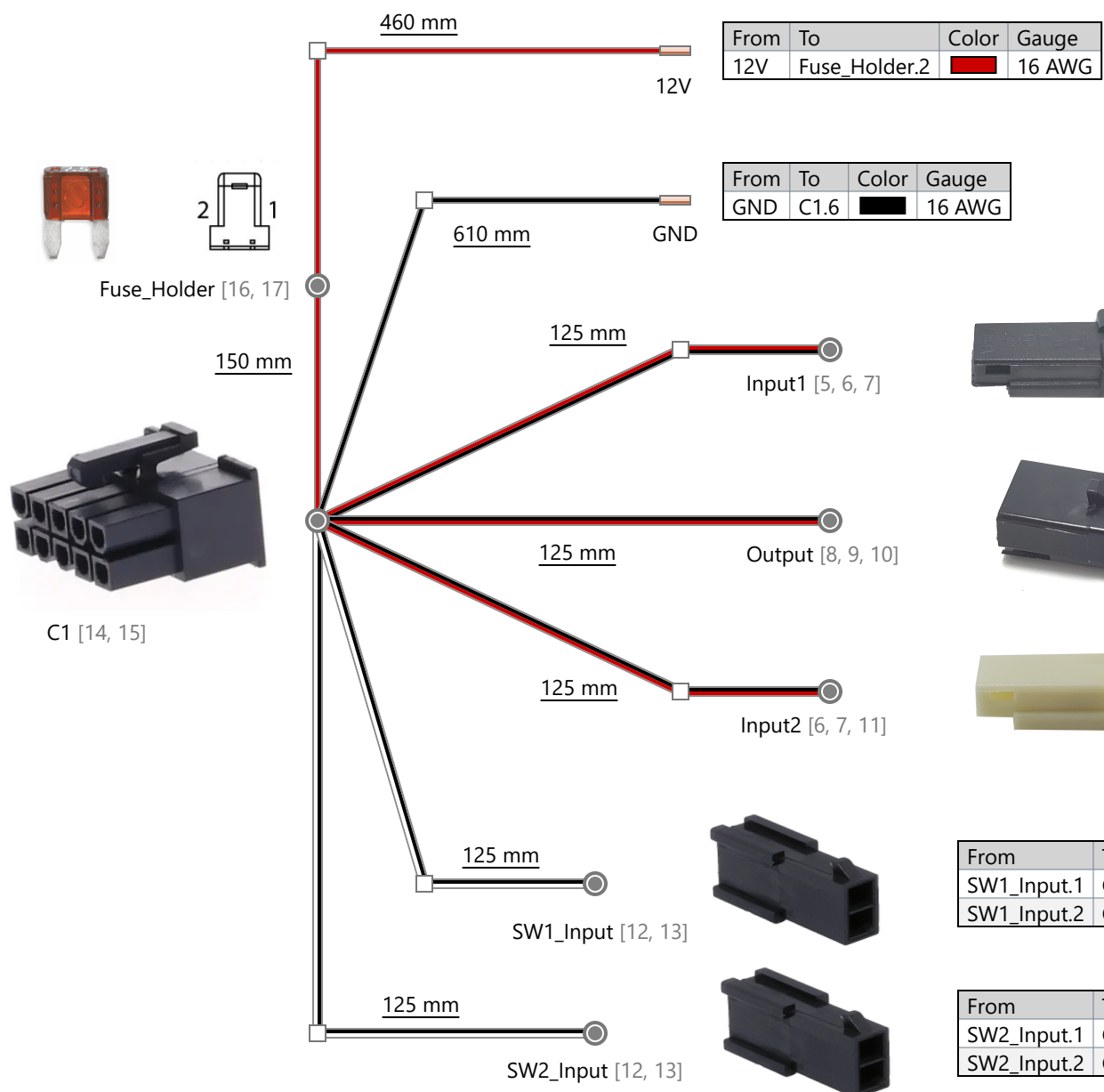

From	To	Color	Gauge
12V	Fuse_Holder.2	Red	16 AWG

From	To	Color	Gauge
GND	C1.6	Black	16 AWG

From	To	Color	Gauge
Input1.A	C1.2	Red	16 AWG
Input1.B	C1.7	Black	16 AWG

From	To	Color	Gauge
Output.A	C1.3	Red	16 AWG
Output.B	C1.8	Black	16 AWG

From	To	Color	Gauge
Input2.A	C1.4	Red	16 AWG
Input2.B	C1.9	Black	16 AWG

From	To	Color	Gauge
SW1_Input.1	C1.5	White/Black	20 AWG
SW1_Input.2	C1.10	Black	20 AWG

From	To	Color	Gauge
SW2_Input.1	C1.5	White/Black	20 AWG
SW2_Input.2	C1.10	Black	20 AWG

Input.1 for each switch is the ground signal that will be fed back to the timer module for activation

Input.2 for each switch is a ground that will be provided by the timer module

Revisions			
Rev.	Date	Author	Description
v1	03/26/21	Bennet Fisher	Initial Drawing
v2	7/1/2021	Bennet Fisher	Revised pin 4 and 9 connections; spliced switch inputs
v3	7/22/2021	Bennet Fisher	Changed second dome connector
v4	11/8/2021	Bennet Fisher	Eliminated White/Black and Black wire splices; Corrected contacts for C1.4, C1.5, C1.9, and C1.10

UNLESS OTHERWISE SPECIFIED DIMENSIONS ARE IN MILLIMETERS (INCHES) TOLERANCES: ±5MM PROPRIETARY AND CONFIDENTIAL THE INFORMATION CONTAINED IN THIS DRAWING IS THE SOLE PROPERTY OF AAMP GLOBAL. ANY REPRODUCTION IN PART OR AS A WHOLE WITHOUT THE WRITTEN PERMISSION OF AAMP GLOBAL IS PROHIBITED.	Designed By	Bennet Fisher	3/26/21	
	Engineering Approval	----	----	
	Manufacturing Approval	----	----	
	Revision Approval	----	----	
	Quality Assurance	----	----	
Part Number: P-VTM-HAR_		Revision: ----		
Description: Timer Module Harness		Sheet: 1 of 1		



VTM

Voltage Timer Module

INSTALLATION MANUAL





Thank you for purchasing the **VTM**



WHAT'S INCLUDED:

- Voltage Timer Module
- Voltage Timer Module Harness
- Screws

COMPATIBLE ACCESSORIES:

- Vehicle-specific harness (P-VTM-xxx)
- Switch harness (VTM-SWx)
- High current harness (VTM-RLY)

FEATURES:

- Selectable timer durations - 60, 90, 120, and 150 minutes
- Low voltage shut off at 11.8V
- Timer and Low Voltage sense work independently of each other
- Inputs for 2 momentary switches
- 7.5A max current output





OPERATING INSTRUCTIONS:

DIP SWITCH 1 UP/DOWN	DIP SWITCH 2 UP/DOWN	DIP SWITCH 3	DIP SWITCH 4	Timer Duration (Minutes)
Voltage Sense ON/OFF	Timer ON/OFF	UP	DOWN	60
		UP	UP	90
		DOWN	UP	120
		DOWN	DOWN	150

If Voltage Sense is turned ON, low voltage shut down will occur when voltage input drops below 11.8V. To eliminate false triggers, there is a 20 second delay before shut down.

If Voltage Sense is turned OFF, input voltage level will not be monitored.

NOTE: Voltage Sense takes precedence over Timer. Voltage Sense is only active when the Switch Inputs are activated. Voltage Sense does not monitor VTM Trigger Input.

If Timer is ON and a switch input is activated, output voltage will be provided for specified timer duration.

While output voltage is active, pressing a switch will disable the output voltage. If pressed once again, output voltage will be re-activated and reset the timer.

Trigger Input	Switch Input	Output	Voltage Sense (ON)	Timer (ON)
Active	N/A	ON	N/A	N/A
Deactivated	N/A	OFF	N/A	N/A
Not Active	Activated (Pressed)	ON	Monitoring Input Voltage	Timer starts
Not Active	Activated (Pressed)	OFF	N/A	Timer off
Not Active	Activated (Pressed)	ON	Monitoring Input Voltage	Timer resets

If VTM Trigger Input to the VTM module is active, its function takes precedence.



WIRING DIAGRAMS:

VTM Harness

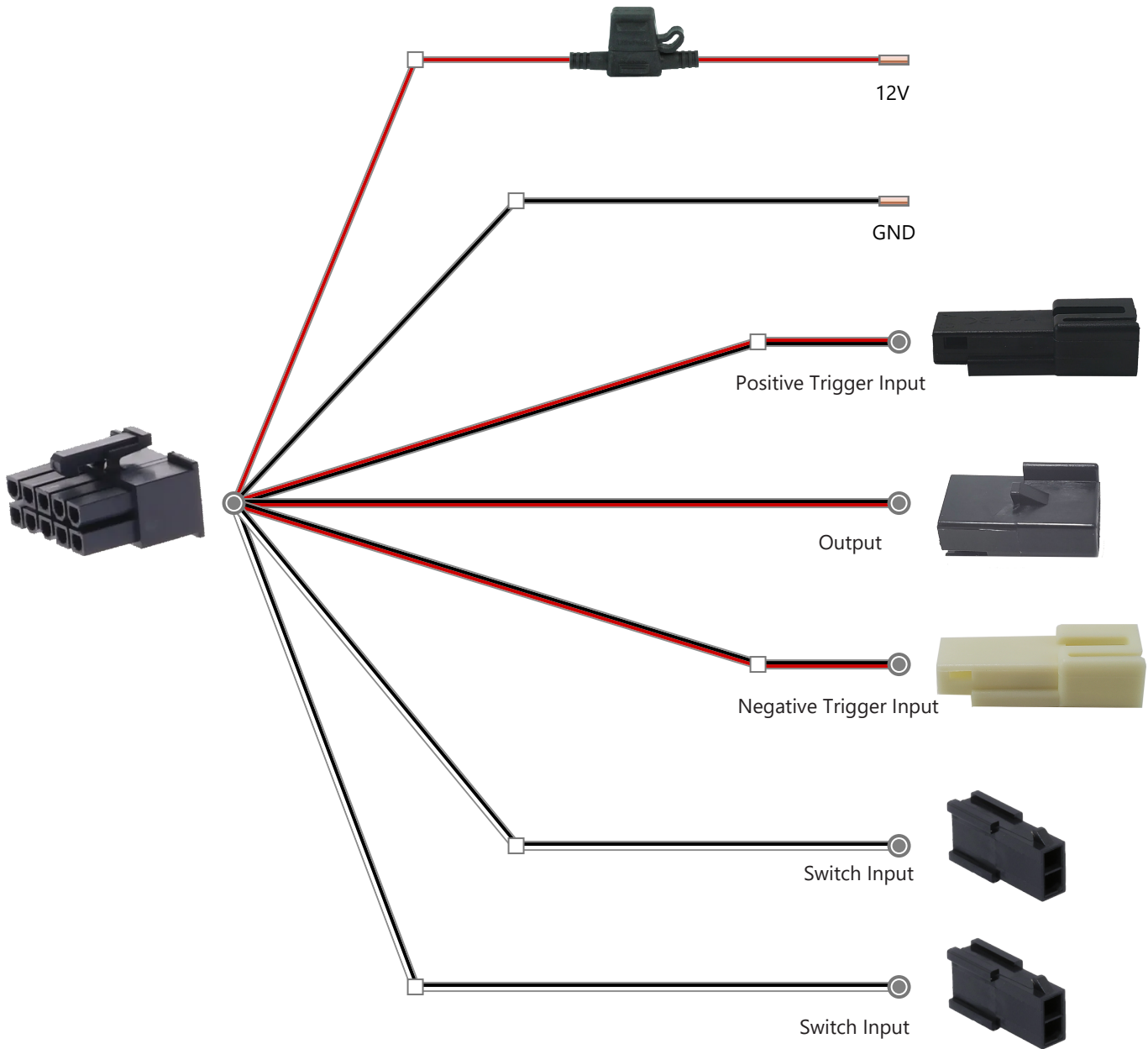

VTM-RLY (Optional Harness)

For larger current demands, use the optional VTM-RLY and connect to power and ground, along with the VTM harness. VTM-RLY supports up to 15A.

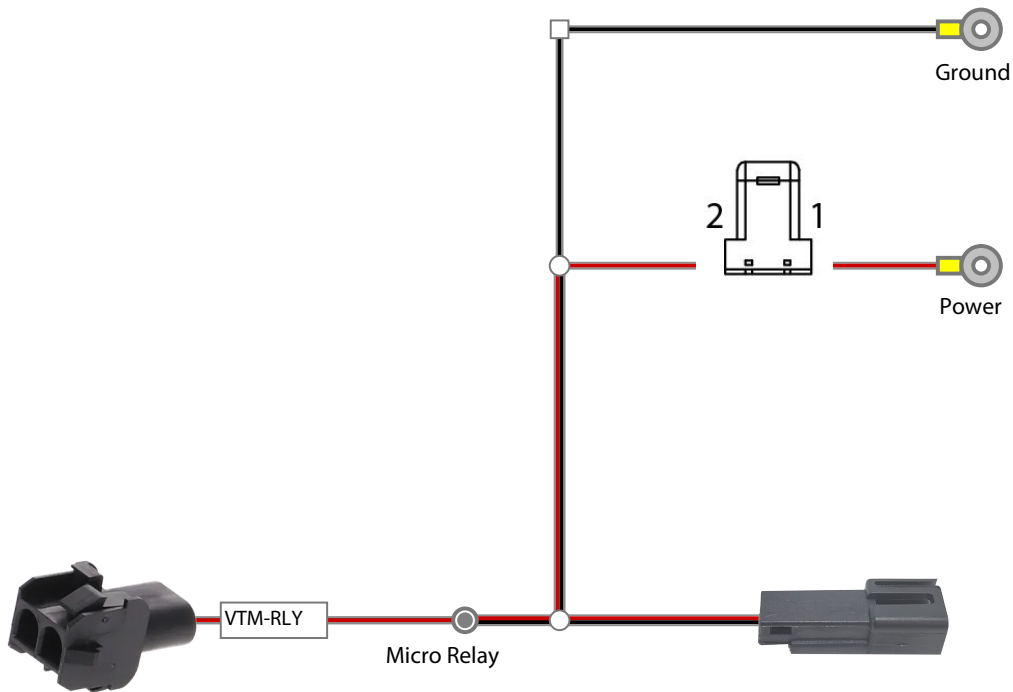

VTM-RLY Output connects to the P-VTMxxx harness for vehicle lighting

VTM-RLY Input connects to the output from the VTM harness





Phone – 866-931-8021 (option 3)

E-Mail – support@echomasterfleetsolutions.com



EchoMaster Fleet Solutions is a Power Brand of AAMP Global

EchoMasterfleetsolutions.com

PURCHASED COMPONENT KEY FEATURES

DESCRIPTION OF REQUIREMENTS

DIMENSIONAL REQUIREMENTS (AS SHOWN ON DRAWING)

N/A

LOAD/RATING REQUIREMENT

N/A

MATERIAL REQUIREMENT

N/A

PACKAGING REQUIREMENT

N/A

OTHER REQUIREMENTS



THIS DRAWING IS THE PROPERTY OF ADRIAN STEEL COMPANY AND IS NOT TO BE USED IN ANY MANNER DETRIMENTAL TO THE INTERESTS OF ADRIAN STEEL COMPANY

TOLERANCES & INSPECTION

UNLESS OTHERWISE SPECIFIED

ALL BEND ANGLES ARE 90 DEGREES

ALL DIMENSIONS ARE IN INCHES.

REFERENCE DIMENSIONS (X.XXX)
DO NOT REQUIRE INSPECTION

FEATURES	HOLES/SLOTS	ANGLES
0.0 = ± .125	0.0 = ± .062	0° = ± 2°
0.00 = ± .062	0.00 = ± .031	0.0° = ± 1°
0.000 = ± .031	0.000 = ± .015	

Material Thickness: per ASTM Std.
Weld Callouts per AWS

RELEASE & REVISIONS

INITIAL ECN: **25377**

CURRENT ECN: **25377**

ECN DESCRIPTION:

RELEASE FOR PRODUCTION

REVISED BY:

PURCHASED COMPONENT

REFERENCED SUPPLIER AND/OR MANUFACTURER

AAMP GLOBAL

REFERENCED SUPPLIER AND/OR MANUFACTURER PART NUMBER

VTM-SW2 OR 65788

COLOR (ONLY LIST IF COLOR SPECIFIC)

COMODITY ITEM (Y/N) (YES = ALL DIMENSIONS AND NOTES ARE REFERENCE)
(NOTE: DIMENSIONS AND FEATURES MAY VARY FOR A COMODITY ITEM.)

NO

PRINTED DOCUMENT IS UNCONTROLLED

Sheet 1 of 1

PART / PRODUCT IDENTIFICATION



ADRIAN STEEL®

ADRIAN STEEL COMPANY
906 JAMES STREET, ADRIAN, MI 49221

REVISION LEVEL

A

MAT'L USED: **PURCHASED**

DESIGNED BY: **E.BURKE**



DESCRIPTION: **SWITCH 2 HARNESS FOR VTM**

WEIGHT (Lbs.): **0.2**

SEGMENT CODE: **ELE**

PART NUMBER: **65788**

Coverings	
Id	Assembly
[6]	

From	To	Color	Gauge
C1.1	QC1		20 AWG
C1.2	QC2		20 AWG

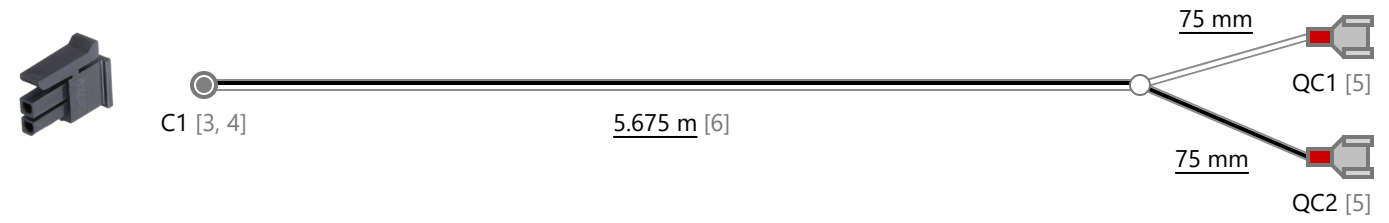

From	To	Color	Gauge
QC1	C1.1		20 AWG

From	To	Color	Gauge
QC2	C1.2		20 AWG



<p>UNLESS OTHERWISE SPECIFIED DIMENSIONS ARE IN MILLIMETERS [INCHES] TOLERANCES: ±5MM</p> <p>PROPRIETARY AND CONFIDENTIAL</p> <p>THE INFORMATION CONTAINED IN THIS DRAWING IS THE SOLE PROPERTY OF AAMP GLOBAL. ANY REPRODUCTION IN PART OR AS A WHOLE WITHOUT THE WRITTEN PERMISSION OF AAMP GLOBAL IS PROHIBITED.</p>		Name	Date	
	Designed By	Bennet Fisher	6/10/2021	
	Engineering Approval			
	Manufacturing Approval			
	Revision Approval			
Quality Assurance				
	Part Number: VTM-SW2		Revision: 1	
	Description: 5.675 Meter Switch Harness		Sheet: ----	

Revisions			
Rev.	Date	Author	Description
1	6/10/21	Bennet Fisher	Initial Drawing

PURCHASED COMPONENT KEY FEATURES

DESCRIPTION OF REQUIREMENTS

DIMENSIONAL REQUIREMENTS (AS SHOWN ON DRAWING)

N/A

LOAD/RATING REQUIREMENT

N/A

MATERIAL REQUIREMENT

N/A

PACKAGING REQUIREMENT

N/A

OTHER REQUIREMENTS



THIS DRAWING IS THE PROPERTY OF ADRIAN STEEL COMPANY AND IS NOT TO BE USED IN ANY MANNER DETRIMENTAL TO THE INTERESTS OF ADRIAN STEEL COMPANY

TOLERANCES & INSPECTION

UNLESS OTHERWISE SPECIFIED

ALL BEND ANGLES ARE 90 DEGREES

ALL DIMENSIONS ARE IN INCHES.

REFERENCE DIMENSIONS (X.XXX)
DO NOT REQUIRE INSPECTION

FEATURES	HOLES/SLOTS	ANGLES
0.0 = ± .125	0.0 = ± .062	0° = ± 2°
0.00 = ± .062	0.00 = ± .031	0.0° = ± 1°
0.000 = ± .031	0.000 = ± .015	

Material Thickness: per ASTM Std.
Weld Callouts per AWS

RELEASE & REVISIONS

INITIAL ECN: **25377**

CURRENT ECN: **25377**

ECN DESCRIPTION:

RELEASE FOR PRODUCTION

REVISED BY:

PURCHASED COMPONENT

REFERENCED SUPPLIER AND/OR MANUFACTURER

AAMP GLOBAL

REFERENCED SUPPLIER AND/OR MANUFACTURER PART NUMBER

VTM-SW4 OR 65790

COLOR (ONLY LIST IF COLOR SPECIFIC)

COMODITY ITEM (Y/N) (YES = ALL DIMENSIONS AND NOTES ARE REFERENCE)
(NOTE: DIMENSIONS AND FEATURES MAY VARY FOR A COMODITY ITEM.)

NO

PRINTED DOCUMENT IS UNCONTROLLED

Sheet 1 of 1

PART / PRODUCT IDENTIFICATION



ADRIAN STEEL

ADRIAN STEEL COMPANY
906 JAMES STREET, ADRIAN, MI 49221

REVISION LEVEL

A

MAT'L USED: **PURCHASED**

DESIGNED BY: **E.BURKE**



DESCRIPTION: **SWITCH 4 HARNESS FOR VTM**

WEIGHT (Lbs.): **0.2**

SEGMENT CODE: **ELE**

PART NUMBER: **65790**

Coverings	
Id	Assembly
[6]	

From	To	Color	Gauge
C1.1	QC1		20 AWG
C1.2	QC2		20 AWG

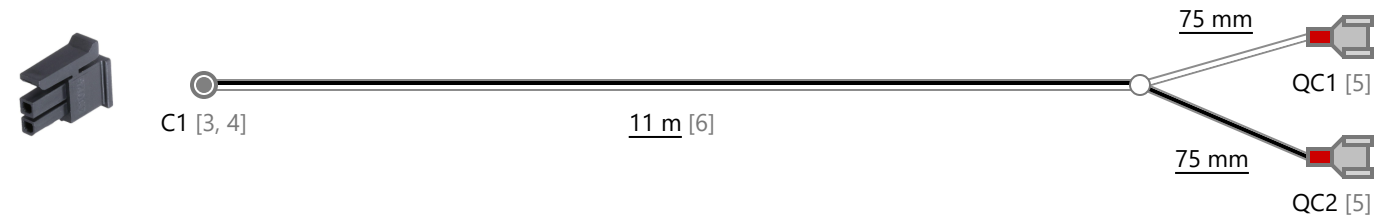

From	To	Color	Gauge
QC1	C1.1		20 AWG

From	To	Color	Gauge
QC2	C1.2		20 AWG



UNLESS OTHERWISE SPECIFIED DIMENSIONS ARE IN MILLIMETERS [INCHES] TOLERANCES: ±5MM PROPRIETARY AND CONFIDENTIAL THE INFORMATION CONTAINED IN THIS DRAWING IS THE SOLE PROPERTY OF AAMP GLOBAL. ANY REPRODUCTION IN PART OR AS A WHOLE WITHOUT THE WRITTEN PERMISSION OF AAMP GLOBAL IS PROHIBITED.		Name	Date	 — ADVANCING VEHICLE TECHNOLOGY —
	Designed By	Bennet Fisher	6/10/2021	
	Engineering Approval			
	Manufacturing Approval			
	Revision Approval			
Quality Assurance				
	Part Number: VTM-SW4		Revision: 1	
	Description:		Sheet:	
	11 Meter Switch Harness		----	

Revisions			
Rev.	Date	Author	Description
1	6/10/21	Bennet Fisher	Initial Drawing

PURCHASED COMPONENT KEY FEATURES

DESCRIPTION OF REQUIREMENTS

DIMENSIONAL REQUIREMENTS (AS SHOWN ON DRAWING)

N/A

LOAD/RATING REQUIREMENT

N/A

MATERIAL REQUIREMENT

N/A

PACKAGING REQUIREMENT

N/A

OTHER REQUIREMENTS

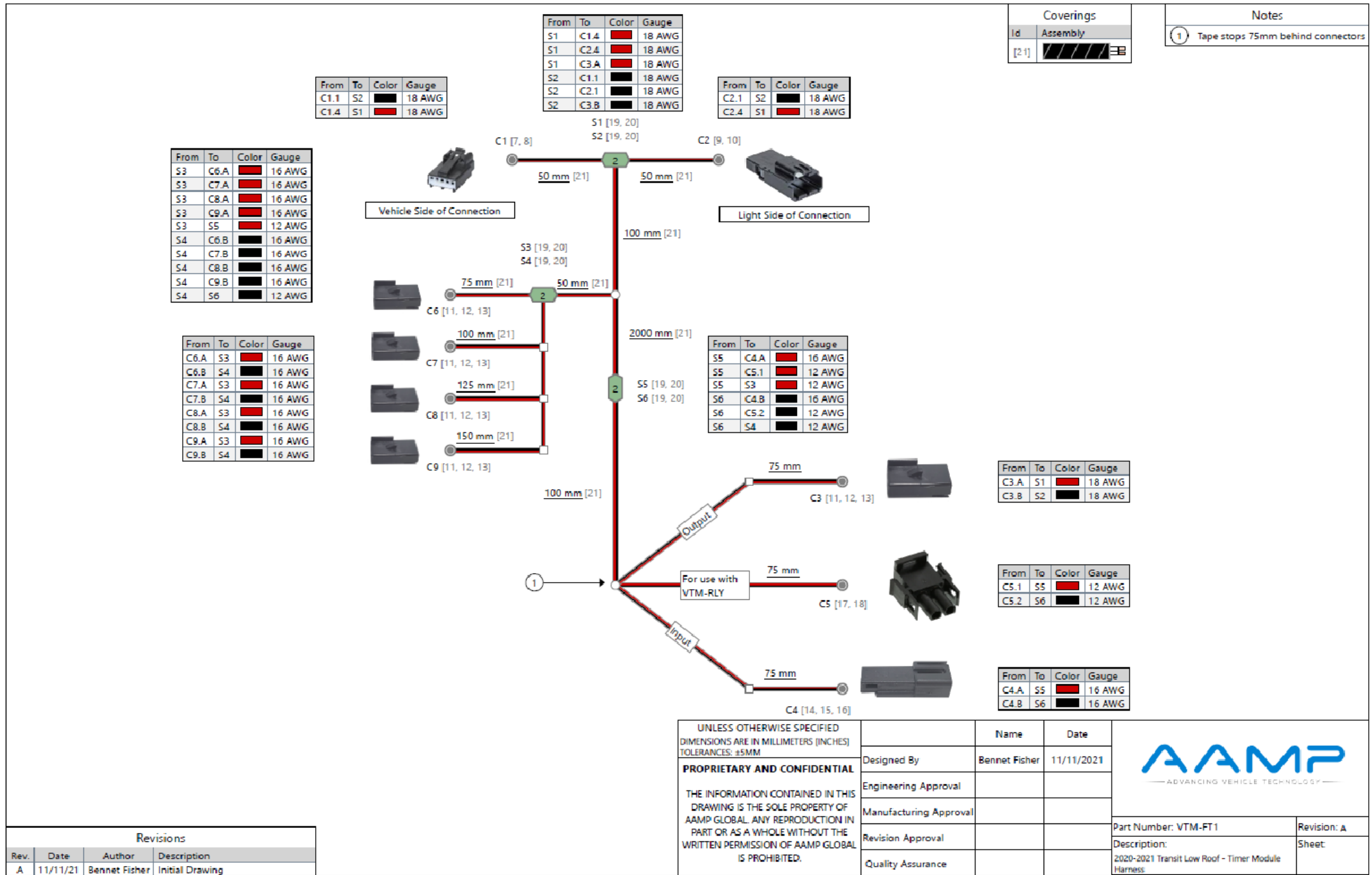

THIS DRAWING IS THE PROPERTY OF ADRIAN STEEL COMPANY AND IS NOT TO BE USED IN ANY MANNER DETRIMENTAL TO THE INTERESTS OF ADRIAN STEEL COMPANY

TOLERANCES & INSPECTION

RELEASE & REVISIONS

UNLESS OTHERWISE SPECIFIED
ALL BEND ANGLES ARE 90 DEGREES
ALL DIMENSIONS ARE IN INCHES.
REFERENCE DIMENSIONS (X.XXX)
DO NOT REQUIRE INSPECTION

FEATURES	HOLES/SLOTS	ANGLES
0.0 = ± .125	0.0 = ± .062	0° = ± 2°
0.00 = ± .062	0.00 = ± .031	0.0° = ± 1°
0.000 = ± .031	0.000 = ± .015	

Material Thickness: per ASTM Std.
Weld Callouts per AWS

INITIAL ECN: **25377**
CURRENT ECN: **25377**
ECN DESCRIPTION:
RELEASE FOR PRODUCTION
REVISED BY: **EMB**

PURCHASED COMPONENT

REFERENCED SUPPLIER AND/OR MANUFACTURER
AAMP GLOBAL

REFERENCED SUPPLIER AND/OR MANUFACTURER PART NUMBER
VTM-FT1 OR 65793

COLOR (ONLY LIST IF COLOR SPECIFIC)
NO

COMODITY ITEM (Y/N) (YES = ALL DIMENSIONS AND NOTES ARE REFERENCE)
(NOTE: DIMENSIONS AND FEATURES MAY VARY FOR A COMODITY ITEM.)
NO

PRINTED DOCUMENT IS UNCONTROLLED

Sheet 1 of 1

PART / PRODUCT IDENTIFICATION

	ADRIAN STEEL	ADRIAN STEEL COMPANY 906 JAMES STREET, ADRIAN, MI 49221	REVISION LEVEL A
	MAT'L USED: PURCHASED	DESIGNED BY: E.BURKE	
DESCRIPTION: HARN, POWER VTM FT1			
WEIGHT (Lbs.): 0.2	SEGMENT CODE: ELE	PART NUMBER: 65793	

Coverings	
Id	Assembly
[21]	

Notes
 ① Tape stops 75mm behind connectors

From	To	Color	Gauge
S1	C1.4	Red	18 AWG
S1	C2.4	Red	18 AWG
S1	C3.A	Red	18 AWG
S2	C1.1	Black	18 AWG
S2	C2.1	Black	18 AWG
S2	C3.B	Black	18 AWG

From	To	Color	Gauge
C1.1	S2	Black	18 AWG
C1.4	S1	Red	18 AWG

From	To	Color	Gauge
C2.1	S2	Black	18 AWG
C2.4	S1	Red	18 AWG

From	To	Color	Gauge
S3	C6.A	Red	16 AWG
S3	C7.A	Red	16 AWG
S3	C8.A	Red	16 AWG
S3	C9.A	Red	16 AWG
S3	S5	Red	12 AWG
S4	C6.B	Black	16 AWG
S4	C7.B	Black	16 AWG
S4	C8.B	Black	16 AWG
S4	C9.B	Black	16 AWG
S4	S6	Black	12 AWG

From	To	Color	Gauge
C6.A	S3	Red	16 AWG
C6.B	S4	Black	16 AWG
C7.A	S3	Red	16 AWG
C7.B	S4	Black	16 AWG
C8.A	S3	Red	16 AWG
C8.B	S4	Black	16 AWG
C9.A	S3	Red	16 AWG
C9.B	S4	Black	16 AWG

From	To	Color	Gauge
S5	C4.A	Red	16 AWG
S5	C5.1	Red	12 AWG
S5	S3	Red	12 AWG
S6	C4.B	Black	16 AWG
S6	C5.2	Black	12 AWG
S6	S4	Black	12 AWG

From	To	Color	Gauge
C3.A	S1	Red	18 AWG
C3.B	S2	Black	18 AWG

From	To	Color	Gauge
C5.1	S5	Red	12 AWG
C5.2	S6	Black	12 AWG

From	To	Color	Gauge
C4.A	S5	Red	16 AWG
C4.B	S6	Black	16 AWG

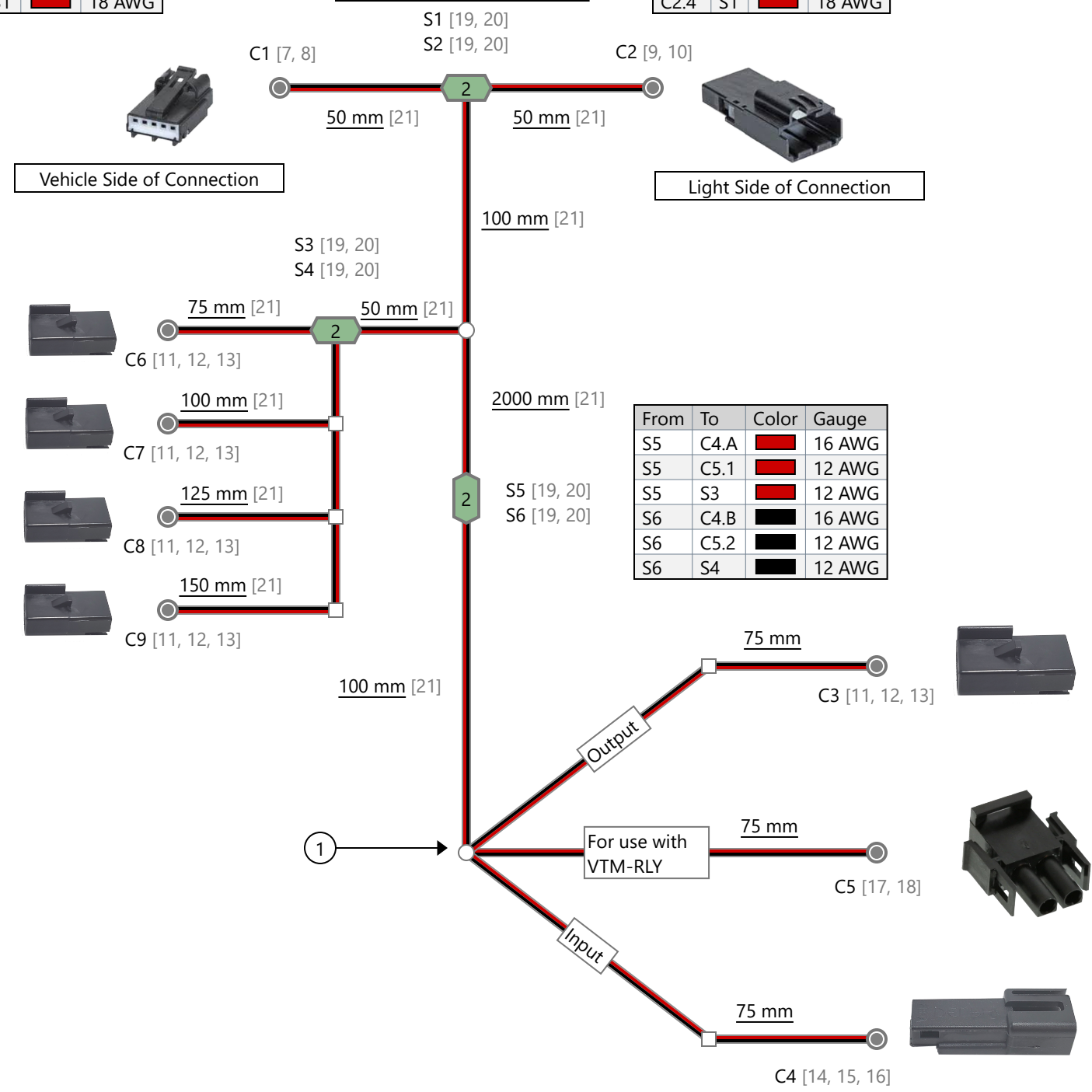

UNLESS OTHERWISE SPECIFIED
 DIMENSIONS ARE IN MILLIMETERS [INCHES]
 TOLERANCES: ±5MM

PROPRIETARY AND CONFIDENTIAL

THE INFORMATION CONTAINED IN THIS DRAWING IS THE SOLE PROPERTY OF AAMP GLOBAL. ANY REPRODUCTION IN PART OR AS A WHOLE WITHOUT THE WRITTEN PERMISSION OF AAMP GLOBAL IS PROHIBITED.

	Name	Date
Designed By	Bennet Fisher	11/11/2021
Engineering Approval		
Manufacturing Approval		
Revision Approval		
Quality Assurance		



Part Number: VTM-FT1
 Description: 2020-2021 Transit Low Roof - Timer Module Harness
 Revision: A
 Sheet:

Revisions

Rev.	Date	Author	Description
A	11/11/21	Bennet Fisher	Initial Drawing

PURCHASED COMPONENT KEY FEATURES

DESCRIPTION OF REQUIREMENTS

DIMENSIONAL REQUIREMENTS (AS SHOWN ON DRAWING)

N/A

LOAD/RATING REQUIREMENT

N/A

MATERIAL REQUIREMENT

N/A

PACKAGING REQUIREMENT

N/A

OTHER REQUIREMENTS

**RING TERMINAL:
16-14GA
1/4" STUD SIZE
BLUE
TIN PLATED COPPER**



THIS DRAWING IS THE PROPERTY OF ADRIAN STEEL COMPANY AND IS NOT TO BE USED IN ANY MANNER DETRIMENTAL TO THE INTERESTS OF ADRIAN STEEL COMPANY

TOLERANCES & INSPECTION

UNLESS OTHERWISE SPECIFIED

ALL BEND ANGLES ARE 90 DEGREES

ALL DIMENSIONS ARE IN INCHES.

REFERENCE DIMENSIONS (X.XXX)
DO NOT REQUIRE INSPECTION

FEATURES	HOLES/SLOTS	ANGLES
0.0 = ± .125	0.0 = ± .062	0° = ± 2°
0.00 = ± .062	0.00 = ± .031	0.0° = ± 1°
0.000 = ± .031	0.000 = ± .015	

Material Thickness: per ASTM Std.
Weld Callouts per AWS

RELEASE & REVISIONS

INITIAL ECN: **25975**

CURRENT ECN: **25975**

ECN DESCRIPTION:

RELEASE TO PRODUCTION

REVISED BY: **N/A**

PURCHASED COMPONENT

REFERENCED SUPPLIER AND/OR MANUFACTURER

WAYTEK

REFERENCED SUPPLIER AND/OR MANUFACTURER PART NUMBER

37393

COLOR (ONLY LIST IF COLOR SPECIFIC)

BLUE

COMODITY ITEM (Y/N) (YES = ALL DIMENSIONS AND NOTES ARE REFERENCE)
(NOTE: DIMENSIONS AND FEATURES MAY VARY FOR A COMODITY ITEM.)

NO

PRINTED DOCUMENT IS UNCONTROLLED

Sheet 1 of 1

PART / PRODUCT IDENTIFICATION



ADRIAN STEEL®

ADRIAN STEEL COMPANY
906 JAMES STREET, ADRIAN, MI 49221

REVISION LEVEL

A

MAT'L USED: **PURCHASED**

DESIGNED BY: **EMB**

DESCRIPTION: **WIRE TERM 1/4"RING 14-16G**

WEIGHT (Lbs.): **0.01**

SEGMENT CODE: **ELE**

PART NUMBER: **69511**