

# PURCHASED COMPONENT KEY FEATURES

## DESCRIPTION OF REQUIREMENTS

DIMENSIONAL REQUIREMENTS (AS SHOWN ON DRAWING)

N/A

LOAD/RATING REQUIREMENT

N/A

MATERIAL REQUIREMENT

N/A

PACKAGING REQUIREMENT

N/A

OTHER REQUIREMENTS

**Note: Fits 2018-2021 vehicles.**



THIS DRAWING IS THE PROPERTY OF ADRIAN STEEL COMPANY AND IS NOT TO BE USED IN ANY MANNER DETRIMENTAL TO THE INTERESTS OF ADRIAN STEEL COMPANY

PRINTED DOCUMENT IS UNCONTROLLED

Sheet 1 of 1

## TOLERANCES & INSPECTION

*UNLESS OTHERWISE SPECIFIED*

ALL BEND ANGLES ARE 90 DEGREES

ALL DIMENSIONS ARE IN INCHES.

REFERENCE DIMENSIONS (X.XXX)  
DO NOT REQUIRE INSPECTION

FEATURES	HOLES/SLOTS	ANGLES
0.0 = ± .125	0.0 = ± .062	0° = ± 2°
0.00 = ± .062	0.00 = ± .031	0.0° = ± 1°
0.000 = ± .031	0.000 = ± .015	

Material Thickness: per ASTM Std.  
Weld Callouts per AWS

## RELEASE & REVISIONS

INITIAL ECN: **24870**

CURRENT ECN: **24870**

ECN DESCRIPTION:

**QE8672 Release Module LED Harn PM/PMC**

REVISED BY: **N/A**

# PURCHASED COMPONENT

REFERENCED SUPPLIER AND/OR MANUFACTURER

**AAMP**

REFERENCED SUPPLIER AND/OR MANUFACTURER PART NUMBER

**CL-RPM**

COLOR (ONLY LIST IF COLOR SPECIFIC)

COMODITY ITEM (Y/N) (YES = ALL DIMENSIONS AND NOTES ARE REFERENCE)  
(NOTE: DIMENSIONS AND FEATURES MAY VARY FOR A COMODITY ITEM.)

**YES**

## PART / PRODUCT IDENTIFICATION



**ADRIAN STEEL®**

ADRIAN STEEL COMPANY  
906 JAMES STREET, ADRIAN, MI 49221

REVISION LEVEL

**A**

MAT'L USED:

DESIGNED BY: **JLT**

DESCRIPTION:

**MODULE LED HARN PM/PMC**

WEIGHT (Lbs.): **.01**

SEGMENT CODE: **ELE**

PART NUMBER: **64856**



CL-RPM

**Wiring Harness for Cargo Lighting  
2015-2022 ProMaster City, 2018-2023 ProMaster, and  
2022 ProMaster 1500 Low Roof**

**INSTALLATION MANUAL**



# Thank you for purchasing the **CL-RPM**

---

## Table of Contents

- Page 3** - Tools Required For Installing Additional Accessories
- Page 4** - Ram ProMaster Installation
- Page 7** - Ram ProMaster City Installation
- Page 10 & 11** - Wiring Diagrams

## WHAT'S INCLUDED:

---

- Vehicle Specific Wire Harness (CL-RPM)

## COMPATIBLE ACCESSORIES:

---

- LED Dome Lamp (STL40489-2)
- 1100mm Roof Bow Harness (P-HARRB1)
- 1570mm Roof Bow Harness (P-HARRB2)
- 2570mm Roof Bow Harness (P-HARRB3)
- 3470mm Roof Bow Harness (P-HARRB4)
- Adapter Harness (CL-ADP)  
**Note:** Required when installing more than 4 lights in a vehicle



## TOOLS REQUIRED:

---

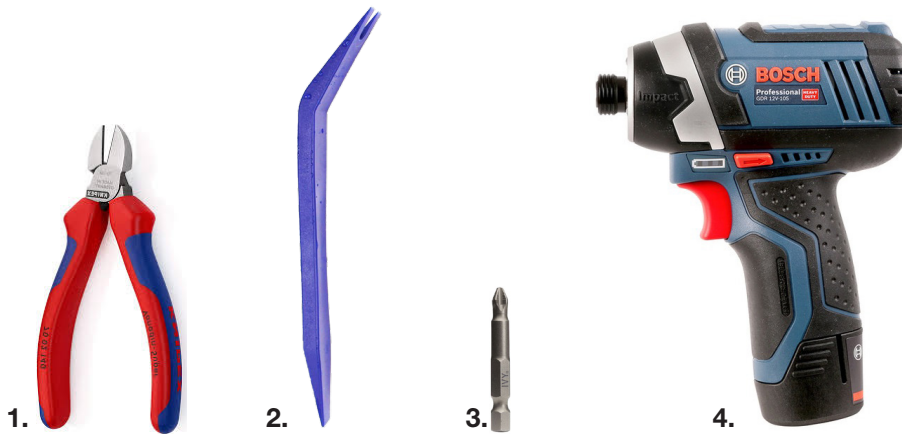

1. Diagonal Cutters
2. Panel Removal Tool
3. Phillips #2 Drill Bit
4. Drill



## STEP 1:

Remove the OEM cargo lamp that is located on the passenger side roof line behind the slider door with a panel removal tool.

### Notes:

- OEM cargo lamp is located above rear doors on **2022 Ram ProMaster 1500 Low Roof**
- The factory light will no longer be used



## STEP 2:

Disconnect the OEM connector from the light and plug it into the CL-RPM harness.



### STEP 3:

Install the STL40489 (or alternate CL-xxBLED) lights onto the center of each roof bow; **leave the light connector exposed**

- Peel the red adhesive liners off and stick the light in place
- Use the provided 3/4" screws to secure the STL40489 light to the roof rib.

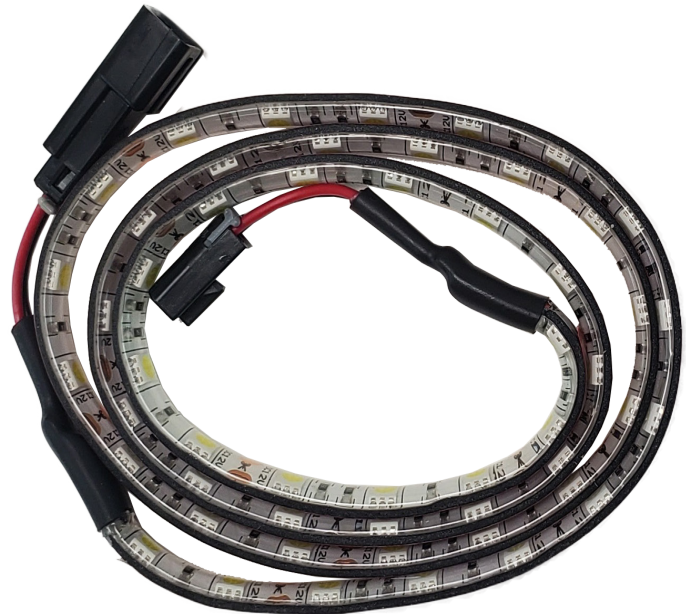

## STEP 4:

Connect the appropriate P-HARRBx roof bow harness to each installed light.

- Refer to the diagrams on pages 10 & 11 to confirm proper P-HARRBx for each roof bow
- Use the provided fir tree cable ties to secure the harness to the vehicle's roof bow
- Trim off excess cable tie material after harness is secure



## STEP 5:

Route all P-HARRBx roof bow harnesses alongside the OEM wire harnesses on the passenger side roof line.

- Tuck the harnesses into place; inside vehicle cavities

## STEP 6:

Plug all installed P-HARRBx harnesses into the mating connectors on the CL-RPM harness.

- Confirm all installed lights are operational



## STEP 1:

Remove the OEM cargo lamp that is located on the passenger side roof line behind the slider door with a panel removal tool

Note: The factory light will no longer be used



## STEP 2:

Disconnect the OEM connector from the light and plug it into the CL-RPM Harness



### STEP 3:

Install the STL40489 (or alternate CL-xxBLED) lights onto the center of each roof bow; **leave the light connector exposed**

- Peel the red adhesive liners off and stick the light in place
- Use the provided 3/4" screws to secure the STL40489 light to the roof rib.

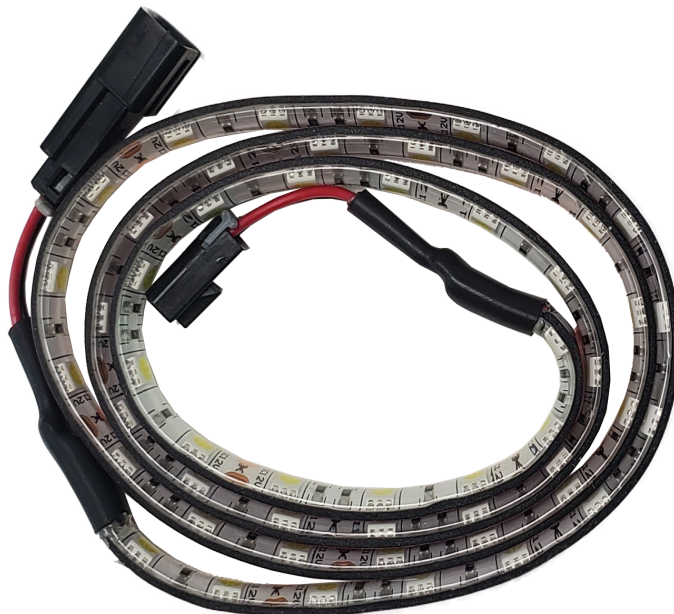

## STEP 4:

Connect the appropriate P-HARRBx roof bow harness to each installed light.

- Refer to the diagram on page 10 to confirm proper P-HARRBx for each roof bow
- Use the provided fir tree cable ties to secure the harness to the vehicle's roof bow
- Trim off excess cable tie material after harness is secure



## STEP 5:

Route all P-HARRBx roof bow harnesses alongside the OEM wire harnesses on the passenger side roof line.

- Tuck the harnesses into place; inside vehicle cavities

## STEP 6:

Plug all installed P-HARRBx harnesses into the mating connectors on the CL-RPM harness.

- Confirm all installed lights are operational



Vehicle	Roof Bow 1	Roof Bow 2	Roof Bow 3	Roof Bow 4	Roof Bow 5	Roof Bow 6
Promaster City	P-HARRB2	P-HARRB1	N/A	N/A	N/A	N/A
Promaster 1500 136" WB	P-HARRB3	P-HARRB1	P-HARRB2	N/A	N/A	N/A
Promaster 1500 136" WB (2022)	P-HARRB3 + P-HARRB2	P-HARRB4	P-HARRB3			
Promaster 2500-3500 159" WB	P-HARRB2	P-HARRB1	P-HARRB1	P-HARRB1	P-HARRB3	P-HARRB3

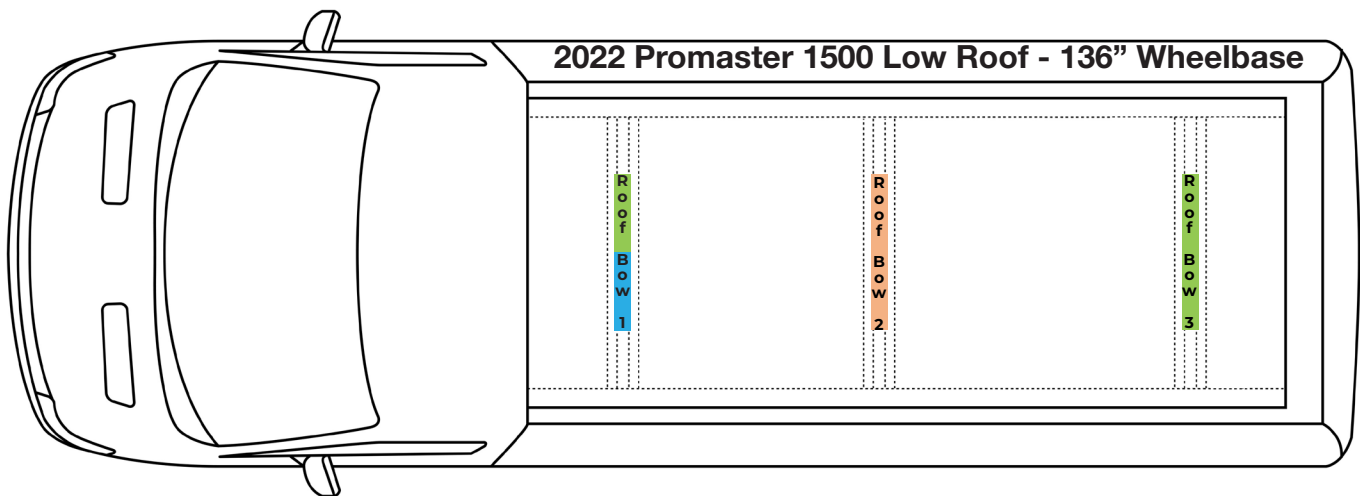
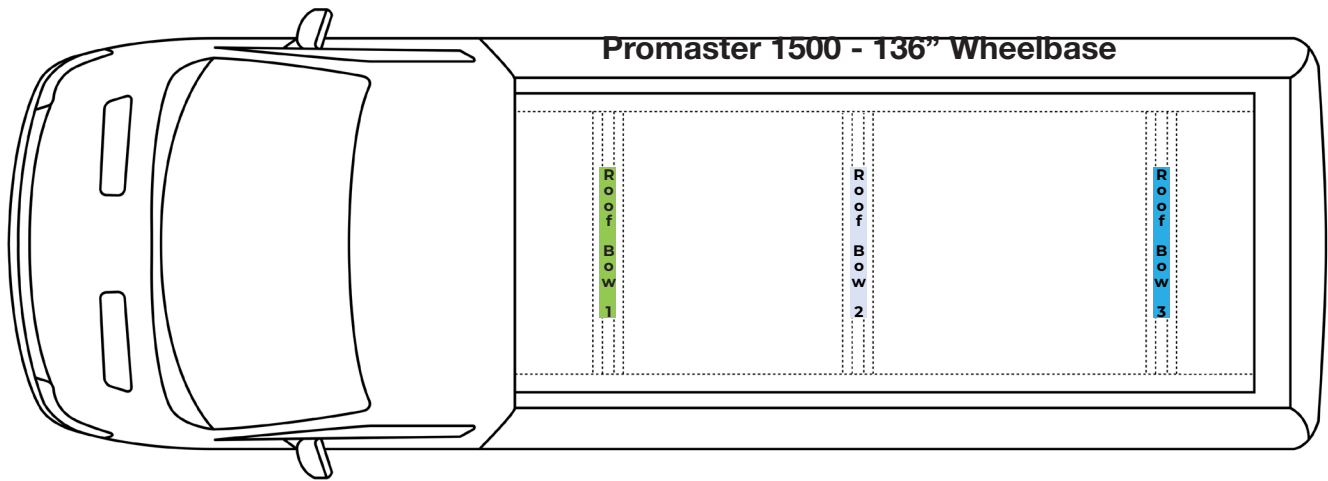
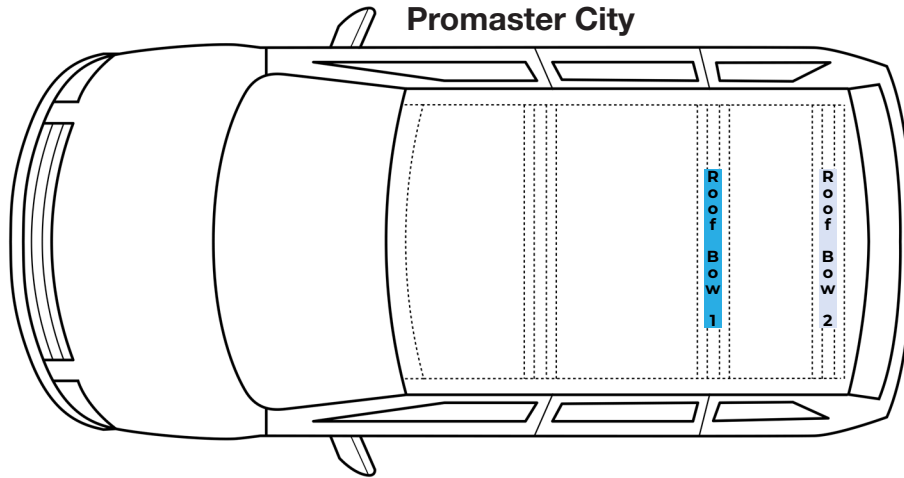

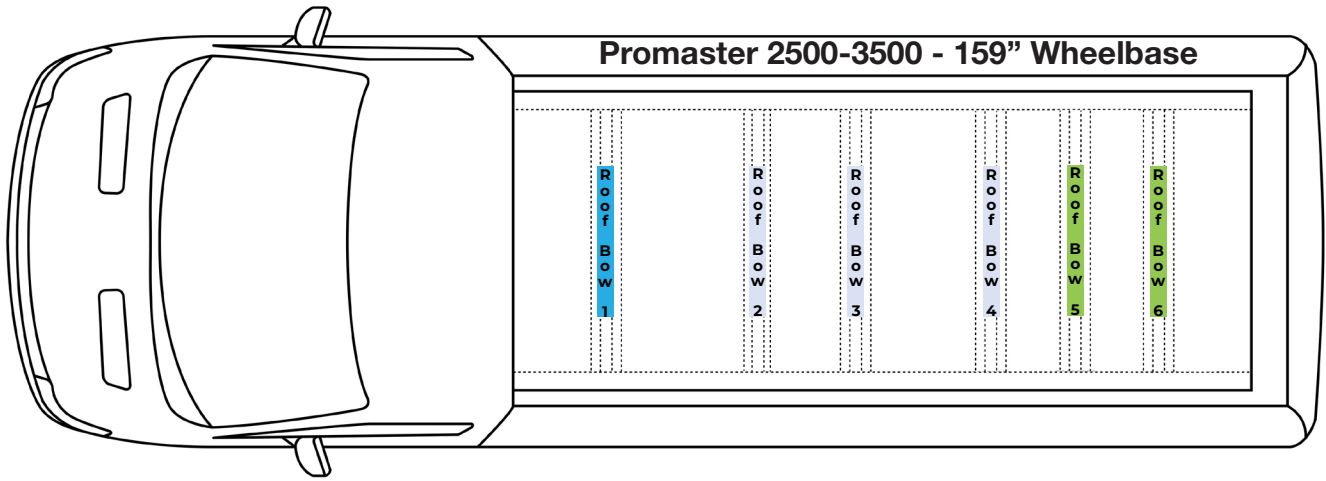



Phone – 866-931-8021 (option 3)

E-Mail – [support@echomasterfleetsolutions.com](mailto:support@echomasterfleetsolutions.com)



**EchoMaster Fleet Solutions is a Power Brand of AAMP Global**

[EchoMaster.com](http://EchoMaster.com)